

Technical Specifications (continued)

Optical

NEMA Type:

NEMA Beam Spread of 5H x 5V

Electrical

Driver:

Constant Current, Class 2, 480V, 50-60Hz, 480V:
0.06A

Dimming Driver:

Driver includes dimming control wiring for 0-10V dimming systems. Requires separate 0-10V DC dimming circuit. Dims down to 10%.

THD:

3.89% at 480V

Power Factor:

92.2% at 480V

Dimensions

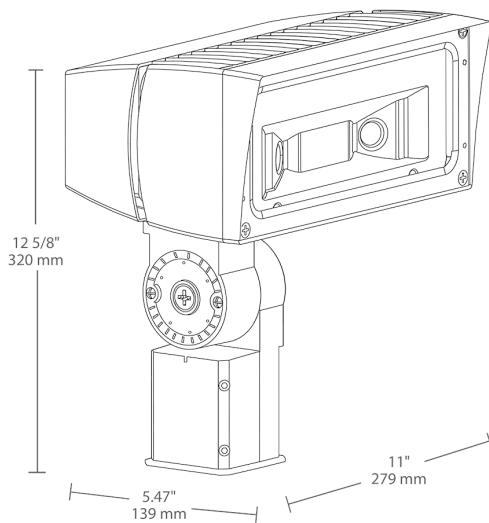

Features

- Ultra-efficient LED and optical design
- Replaces 100W MH floodlights
- 100,000-hour life based on LM-80 results and TM-21 calculations
- "Air-Flow" technology heatsink
- 5-Year, No-Compromise Warranty

Ordering Matrix

Family	Wattage	Mounting	Color Temp	NEMA Type	Finish	Driver	Options	Other Options
FFLED	26	SF	N	B55	W	/480	/PCS4	
	18 = 18W 26 = 26W 39 = 39W 52 = 52W 80 = 80W	Blank = Swivel Arm SF = Slipfitter T = Trunnion	Blank = 5000K Cool N = 4000K Neutral Y = 3000K Warm	Blank = 7H x 6V B55 = 5H x 5V B44 = 4H x 4V	Blank = Bronze W = White	Blank = On/Off ¹ /D10 = 0-10V Dimming /480 = 480V On/Off ² /E = 120-277V Battery Backup /EC = Cold Start Battery Backup	Blank = No Option /PC = 120V Photocell /PC2 = 277V Photocell /PCS = 120V Swivel Photocell /PCS2 = 277V Swivel Photocell /PCS4 = 480V Swivel Photocell /PCU = 120-277V Button Photocell /MS = Mini Sensor /STL3 = Stealth Sensor	Blank = Standard USA = BAA Compliant

¹ Dimming Driver for 18W, 26W & 39W models only

² Not available for 80W models