

Technical Specifications (continued)

Mounting:

Heavy-duty slipfitter for 2 3/8"OD pipe

Lens:

Clear glass lens

Reflector:

Specular vacuum-metalized polycarbonate

Effective Projected Area:

EPA = 2.1

Gaskets:

High-temperature silicone gaskets

Finish:

Formulated for high durability and long-lasting color

Green Technology:

Mercury and UV free. RoHS-compliant components.

Tilt Increment:

Rotates in 6 degree increments

Dimensions

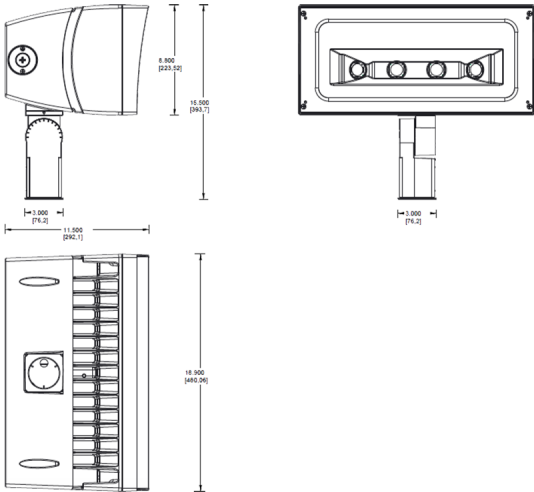

Features

- Ultra-efficient LED and optical design
- 100,000-hour life based on LM-80 results and TM-21 calculations
- "Air-Flow" technology heatsink
- 5-Year, No-Compromise Warranty

Ordering Matrix

Family	Wattage	Mounting	Color Temp	Beam Spread	Finish	Driver Options	Options
FFLED	230	SF		B55	W	/480/D10	/7PR
	180 = 180W 230 = 230W	SF = Slipfitter T = Trunnion	Blank = 5000K Cool N = 4000K Neutral Y = 3000K Warm	Blank = 7H x 6V B44 = 4H x 4V B55 = 5H x 5V	Blank = Bronze W = White	/D10 = 120-277V, 0-10V Dimming /480/D10 = 480V w/ 0-10V Dimming	Blank = No Option /7PR = 7-Pin Receptacle /PCT = 3-Pin Twistlock Photocell 120-277V /PCT4 = 3-Pin Twistlock Photocell 480V /LC = Lightcloud® Controller /SP = 10kV Surge Suppressor