



**Technical Specifications (continued)****Housing:**

Lightweight aluminum housing, steel pan and junction box

**Installation:**

Standard integral T-bar clips secure the fixture to T-bars and prevent T-system separation

**Finish:**

Formulated for high durability and long-lasting color

**Green Technology:**

Mercury and UV free. RoHS-compliant components.

**Lightcloud****Lightcloud Blue Sensor Installed:**

Occupancy, vacancy, and closed loop daylight harvesting in one versatile sensor. In addition control any fixture in your Lightcloud Blue integrated/embedded networked lighting luminaire-level control system. LLLC - capable of switching, 0-10V dimming, power/energy monitoring. Can also be used to extend the range of the Lightcloud Blue utilizing a "BLE Mesh" network communication protocols. The Lightcloud Blue sensor can be attached to the fixture provided an unobstructed view of the coverage area is available. DLC system - N1XMLOEATBA  
[Learn more about Lightcloud.](#)

**LED Characteristics****LEDs:**

Long-life, high-efficacy, surface-mount LEDs

**Sensor Specifications****Capacitance Load:**

400VA at 120VAC, 800VA at 230VAC, 1000VA at 277VAC

**Operating Temperature:**

-20°C to +60°C (-4°F to +140°F)

**Relay:**

Zero-cross relay

**Maximum Mounting Height:**

16.4 feet

**Customizable Detection Area:**

10, 50, 75 or 100%

**Time Delay:**

5s, 30s, 1min, 5min, 10min, 20min, 30min

**Cut Off Period:**

0s, 10s, 1min, 5min, 10min, 30min, 1hr, Bi-Level

**Cut-Off Dimming level:**

10, 20, 30, 50%

**Cut-Off Power:**

Less than 1W

**Daylight Threshold:**

About .2-5 fc for disabled

**Sensor Principle:**

High Frequency

**Microwave Frequency:**

5.8GHz +/- 75MHz

**Microwave Power:**

<0.2mW

**Max Detection Range:**

26 ft diameter at 16 ft mounting height

**Detection Angle:**

About 30 to 150 degrees

**Remote Control Accessory:**

Adjust settings using remote control (catalog# MVSREM). Only available with 0-10V dimming driver options. [Remote control available here.](#)

## Dimensions

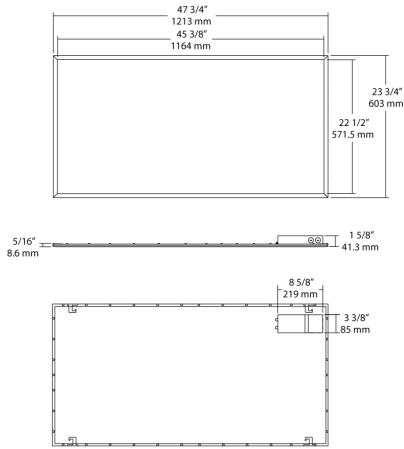







## Features

- Direct Connect to the Lightcloud Blue mobile app via Bluetooth, no Gateway or Hub required
- Use mobile device to configure features for On/Off Control, Dim Level, Schedules, Scenes, and more.
- Meets Luminaire Level Lighting Control (LLLC) requirements
- Integrated passive infrared or microwave sensor for added savings
- Use mobile device to configure sensor settings for sensitivity, timeout and actions.
- Includes emergency battery backup

## Coverage Pattern

## MVS - Occupancy Sensor Detection Pattern

### Features

-  24-hour daylight monitoring dawn/dusk sensor
-  Tri-level dimming control based upon occupancy (*also known as corridor function*)
-  1-10V dimming control method
-  One-touch daylight learning via remote control
-  Zero crossing detection circuit reduces in-rush current and prolongs relay life
-  Loop-in and loop-out terminal for efficient installation

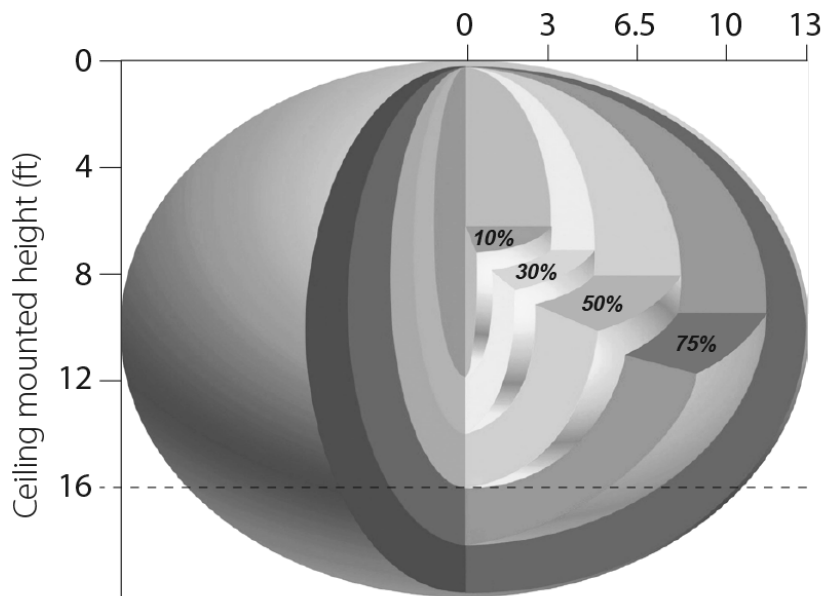

## Ordering Matrix

Family	Size		Wattage	Color Temp	Dimming (standard)	Control Options	Other Options
EZPAN	2X4	-	50	N	/D10	/LCBS/MVS	/E2
	2X4 = 2' x 4' 2X2 = 2' x 2' 1X4 = 1' x 4'		17 = 17W 30 = 30W 40 = 40W 50 = 50W	Blank = 5000K Cool N = 4000K Neutral YN = 3500K Warm Neutral Y = 3000K Warm	/D10 = 0-10V Dimming	Blank = No Option /LC = Lightcloud® Controller /LCB = Lightcloud® Blue Enabled /LCBS = Lightcloud® Blue Enabled w/ PIR Sensor /LCBS/MVS = Lightcloud® Blue Enabled w/ MVS Sensor	Blank = None /E2 = Battery Backup