



## Technical Specifications (continued)

### Lightcloud

#### Lightcloud Blue Sensor Installed:

Occupancy, vacancy, and closed loop daylight harvesting in one versatile sensor. In addition control any fixture in your Lightcloud Blue integrated/embedded networked lighting luminaire-level control system. LLLC - capable of switching, 0-10V dimming, power/energy monitoring. Can also be used to extend the range of the Lightcloud Blue utilizing a "BLE Mesh" network communication protocols. The Lightcloud Blue sensor can be attached to the fixture provided an unobstructed view of the coverage area is available. DLC system - N1XMLOEATBA  
[Learn more about Lightcloud.](#)

### LED Characteristics

#### LEDs:

Long-life, high-efficacy, surface-mount LEDs

### Sensor Specifications

#### Capacitance Load:

400VA at 120VAC, 800VA at 230VAC, 1000VA at 277VAC

#### Operating Temperature:

-20°C to +60°C (-4°F to +140°F)

#### Relay:

Zero-cross relay

#### Maximum Mounting Height:

16.4 feet

#### Customizable Detection Area:

10, 50, 75 or 100%

#### Time Delay:

5s, 30s, 1min, 5min, 10min, 20min, 30min

#### Cut Off Period:

0s, 10s, 1min, 5min, 10min, 30min, 1hr, Bi-Level

#### Cut-Off Dimming level:

10, 20, 30, 50%

#### Cut-Off Power:

Less than 1W

#### Daylight Threshold:

About .2-5 fc for disabled

#### Sensor Principle:

High Frequency

#### Microwave Frequency:

5.8GHz +/- 75MHz

#### Microwave Power:

<0.2mW

#### Max Detection Range:

26 ft diameter at 16 ft mounting height

#### Detection Angle:

About 30 to 150 degrees

#### Remote Control Accessory:

Adjust settings using remote control (catalog# MVSREM). Only available with 0-10V dimming driver options. [Remote control available here.](#)

### Electrical

#### Driver:

Constant Current, Class 2, 50/60 Hz, 120-277V, 120V: 0.34A, 208V: 0.20A, 240V: 0.17A, 277V: 0.15A

#### THD:

8.64% at 120V, 5.93% at 277V

#### Power Factor:

99.1% at 120V, 94.5% at 277V

## Dimensions

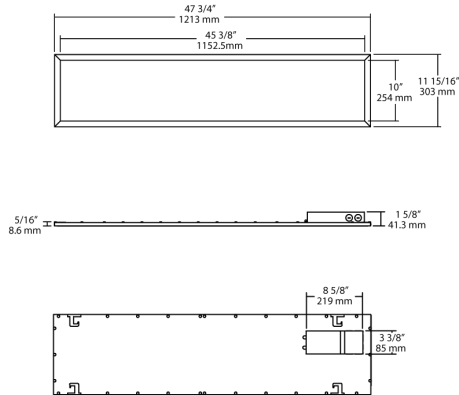

## Features

Direct Connect to the Lightcloud Blue mobile app via Bluetooth, no Gateway or Hub required

Use mobile device to configure features for On/Off Control, Dim Level, Schedules, Scenes, and more.

Meets Luminaire Level Lighting Control (LLLC) requirements

Integrated passive infrared or microwave sensor for added savings







Use mobile device to configure sensor settings for sensitivity, timeout and actions.

Emergency battery backup options available

## Coverage Pattern

## MVS - Occupancy Sensor Detection Pattern

### Features

-  24-hour daylight monitoring dawn/dusk sensor
-  Tri-level dimming control based upon occupancy (*also known as corridor function*)
-  1-10V dimming control method
-  One-touch daylight learning via remote control
-  Zero crossing detection circuit reduces in-rush current and prolongs relay life
-  Loop-in and loop-out terminal for efficient installation



## Ordering Matrix

Family	Size		Wattage	Color Temp	Dimming (standard)	Control Options	Other Options
EZPAN	1X4	-	40	N	/D10	/LCBS/MVS	
	2X4 = 2' x 4' 2X2 = 2' x 2' 1X4 = 1' x 4'		17 = 17W 30 = 30W 40 = 40W 50 = 50W	Blank = 5000K Cool N = 4000K Neutral YN = 3500K Warm Neutral Y = 3000K Warm	/D10 = 0-10V Dimming	Blank = No Sensor /LC = Lightcloud® Controller /LCB = Lightcloud® Blue Enabled /LCBS = Lightcloud® Blue Enabled w/ PIR Sensor /LCBS/MVS = Lightcloud® Blue Enabled w/ MVS Sensor	Blank = None /E2 = Battery Backup