



1' x 4' EZPAN edgelit LED panel lights provide smooth and uniform light edge-to-edge for a clean, modern look. Install in drop ceilings or use optional surface, pendant or recessed (dry wall) mounting kits.

Color: White

Weight: 11.6 lbs

<b>Project:</b>	<b>Type:</b>
<b>Prepared By:</b>	<b>Date:</b>

Driver Info		LED Info	
Type	Constant Current	Watts	30W
120V	0.25A	Color Temp	3000K (Warm)
208V	0.20A	Color Accuracy	81 CRI
240V	0.13A	L70 Lifespan	60,000 Hours
277V	0.12A	Lumens	3,630 lm
Input Watts	31.1W	Efficacy	116.7

## Technical Specifications

### Compliance

#### UL Listed:

Suitable for damp locations

#### CCEA Compliant:

Luminaire Requirements used in Environmental Air Space per the electrical code specification of the City of Chicago

#### Trade Agreements Act Compliant:

This product is a product of Cambodia and a "designated country" end product that complies with the Trade Agreements Act

#### DLC Listed:

This product is on the Design Lights Consortium (DLC) Qualified Products List and is eligible for rebates from DLC Member Utilities. Designed to meet DLC 5.1 requirements.  
DLC Product Code: PEDX3ISX

#### Other

##### Note:

All values are typical (tolerance +/- 10%)

### Warranty:

RAB warrants that our LED products will be free from defects in materials and workmanship for a period of five (5) years from the date of delivery to the end user, including coverage of light output, color stability, driver performance and fixture finish. RAB's warranty is subject to all terms and conditions found at [rablighting.com/warranty](http://rablighting.com/warranty).

### Buy American Act Compliance:

RAB values USA manufacturing! Upon request, RAB may be able to manufacture this product to be compliant with the Buy American Act (BAA). Please contact customer service to request a quote for the product to be made BAA compliant.

### Performance

#### Lifespan:

60,000-Hour LED lifespan based on IES LM-80 results and TM-21 calculations

#### Wattage Equivalency:

Equivalent to (4)F32T8 or (4)F28T5

### Construction

#### Maximum Ambient Temperature:

Suitable for use in up to -30°C (-22°F) to 50°C(122°F)

#### IC Rated:

Suitable for insulated ceilings

### Lens:

Frosted polystyrene

### Mounting:

Recessed ceiling

### Housing:

Lightweight aluminum housing, steel pan and junction box

### Installation:

Standard integral T-bar clips secure the fixture to T-bars and prevent T-system separation

### Finish:

Formulated for high durability and long-lasting color

### Green Technology:

Mercury and UV free. RoHS-compliant components.

## Technical Specifications (continued)

### Lightcloud

#### Lightcloud Blue Sensor Installed:

Occupancy, vacancy, and closed loop daylight harvesting in one versatile sensor. In addition control any fixture in your Lightcloud Blue integrated/embedded networked lighting luminaire-level control system. LLLC - capable of switching, 0-10V dimming, power/energy monitoring. Can also be used to extend the range of the Lightcloud Blue utilizing a "BLE Mesh" network communication protocols. The Lightcloud Blue sensor can be attached to the fixture provided an unobstructed view of the coverage area is available. DLC system - N1XMLOEATBA  
[Learn more about Lightcloud.](#)

### LED Characteristics

#### LEDs:

Long-life, high-efficacy, surface-mount LEDs

### Sensor Specifications

#### Capacitance Load:

400VA at 120VAC, 800VA at 230VAC, 1000VA at 277VAC

#### Operating Temperature:

-20°C to +60°C (-4°F to +140°F)

#### Relay:

Zero-cross relay

#### Maximum Mounting Height:

16.4 feet

#### Customizable Detection Area:

10, 50, 75 or 100%

#### Time Delay:

5s, 30s, 1min, 5min, 10min, 20min, 30min

#### Cut Off Period:

0s, 10s, 1min, 5min, 10min, 30min, 1hr, Bi-Level

#### Cut-Off Dimming level:

10, 20, 30, 50%

#### Cut-Off Power:

Less than 1W

#### Daylight Threshold:

About .2-5 fc for disabled

#### Sensor Principle:

High Frequency

#### Microwave Frequency:

5.8GHz +/- 75MHz

#### Microwave Power:

<0.2mW

#### Max Detection Range:

26 ft diameter at 16 ft mounting height

#### Detection Angle:

About 30 to 150 degrees

#### Remote Control Accessory:

Adjust settings using remote control (catalog# MVSREM). Only available with 0-10V dimming driver options. [Remote control available here.](#)

### Electrical

#### Driver:

Constant Current, Class 2, 50/60 Hz, 120-277V, 120V: 0.25A, 208V: 0.20A, 240V: 0.13A, 277V: 0.12A

#### THD:

7.76% at 120V, 9.61% at 277V

#### Power Factor:

98.9% at 120V, 90.8% at 277V

**Dimensions**

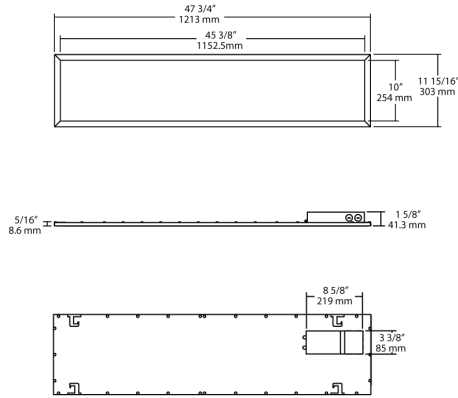







**Features**

- Direct Connect to the Lightcloud Blue mobile app via Bluetooth, no Gateway or Hub required
- Use mobile device to configure features for On/Off Control, Dim Level, Schedules, Scenes, and more.
- Meets Luminaire Level Lighting Control (LLLC) requirements
- Integrated passive infrared or microwave sensor for added savings
- Use mobile device to configure sensor settings for sensitivity, timeout and actions.
- Emergency battery backup options available

**Coverage Pattern**

## MVS - Occupancy Sensor Detection Pattern

### Features

-  24-hour daylight monitoring dawn/dusk sensor
-  Tri-level dimming control based upon occupancy (*also known as corridor function*)
-  1-10V dimming control method
-  One-touch daylight learning via remote control
-  Zero crossing detection circuit reduces in-rush current and prolongs relay life
-  Loop-in and loop-out terminal for efficient installation

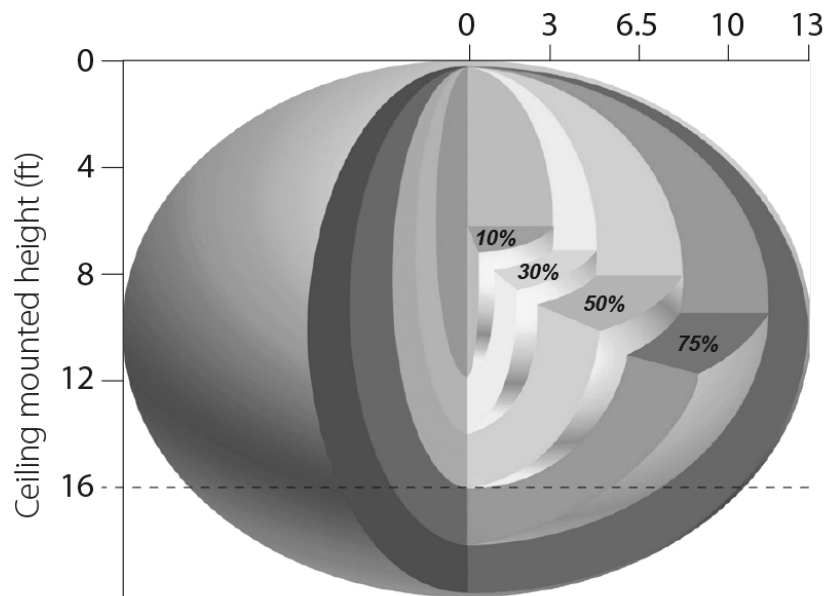

## Ordering Matrix

Family	Size		Wattage	Color Temp	Dimming (standard)	Control Options	Other Options
EZPAN	1X4	-	30	Y	/D10	/LCBS/MVS	
	2X4 = 2' x 4' 2X2 = 2' x 2' 1X4 = 1' x 4'		17 = 17W 30 = 30W 40 = 40W 50 = 50W	Blank = 5000K Cool N = 4000K Neutral YN = 3500K Warm Neutral Y = 3000K Warm	/D10 = 0-10V Dimming	Blank = No Sensor /LC = Lightcloud® Controller /LCB = Lightcloud® Blue Enabled /LCBS = Lightcloud® Blue Enabled w/ PIR Sensor /LCBS/MVS = Lightcloud® Blue Enabled w/ MVS Sensor	Blank = None /E2 = Battery Backup