



Project:	Type:
Prepared By:	Date:

Driver Info		LED Info	
Type	Constant Current	Watts	30W
120V	0.25A	Color Temp	4000K (Neutral)
208V	0.20A	Color Accuracy	82 CRI
240V	0.13A	L70 Lifespan	60,000 Hours
277V	0.12A	Lumens	3,693 lm
Input Watts	30.9W	Efficacy	119

Technical Specifications

Compliance

UL Listed:

Suitable for damp locations

CCEA Compliant:

Luminaire Requirements used in Environmental Air Space per the electrical code specification of the City of Chicago

DLC Listed:

This product is on the Design Lights Consortium (DLC) Qualified Products List and is eligible for rebates from DLC Member Utilities. Designed to meet DLC 5.1 requirements.
DLC Product Code: PZPV6RAV

Other

Note:

All values are typical (tolerance +/- 10%)

Warranty:

RAB warrants that our LED products will be free from defects in materials and workmanship for a period of five (5) years from the date of delivery to the end user, including coverage of light output, color stability, driver performance and fixture finish. RAB's warranty is subject to all terms and conditions found at rablighting.com/warranty.

Buy American Act Compliance:

RAB values USA manufacturing! Upon request, RAB may be able to manufacture this product to be compliant with the Buy American Act (BAA). Please contact customer service to request a quote for the product to be made BAA compliant.

Performance

Lifespan:

60,000-Hour LED lifespan based on IES LM-80 results and TM-21 calculations

Wattage Equivalency:

Equivalent to (4)F32T8 or (4)F28T5

Construction

Maximum Ambient Temperature:

Suitable for use in up to -30°C (-22°F) to 50°C (122°F)

IC Rated:

Suitable for insulated ceilings

Lens:

Frosted polystyrene

Mounting:

Recessed ceiling

Housing:

Lightweight aluminum housing, steel pan and junction box

Installation:

Standard integral T-bar clips secure the fixture to T-bars and prevent T-system separation

Finish:

Formulated for high durability and long-lasting color

Green Technology:

Mercury and UV free. RoHS-compliant components.

Lightcloud

Lightcloud Blue Sensor Installed:

Occupancy, vacancy, and closed loop daylight harvesting in one versatile sensor. In addition control any fixture in your Lightcloud Blue integrated/embedded networked lighting luminaire-level control system. LLLC - capable of switching, 0-10V dimming, power/energy monitoring. Can also be used to extend the range of the Lightcloud Blue utilizing a "BLE Mesh" network communication protocols. The Lightcloud Blue sensor can be attached to the fixture provided an unobstructed view of the coverage area is available.
DLC system - N1XMLOEATBA
[Learn more about Lightcloud.](#)

Technical Specifications (continued)

LED Characteristics

LEDs:

Long-life, high-efficacy, surface-mount LEDs

Electrical

Driver:

Constant Current, Class 2, 50/60 Hz, 120-277V, 120V: 0.25A, 208V: 0.20A, 240V: 0.13A, 277V: 0.12A

THD:

7.76% at 120V, 9.61% at 277V

Power Factor:

98.9% at 120V, 90.8% at 277V

Battery Backup:

Battery backup will operate the fixture for 90 minutes if power fails. Wired for 120-277V.

Battery Backup Light Loss Factor:

0.43

Sensor Specifications

Capacitance Load:

400VA at 120VAC, 800VA at 230VAC, 1000VA at 277VAC

Operating Temperature:

-20°C to +60°C (-4°F to +140°F)

Relay:

Zero-cross relay

Maximum Mounting Height:

16.4 feet

Customizable Detection Area:

10, 50, 75 or 100%

Time Delay:

5s, 30s, 1min, 5min, 10min, 20min, 30min

Cut Off Period:

0s, 10s, 1min, 5min, 10min, 30min, 1hr, Bi-Level

Cut-Off Dimming level:

10, 20, 30, 50%

Cut-Off Power:

Less than 1W

Daylight Threshold:

About .2-5 fc for disabled

Sensor Principle:

High Frequency

Microwave Frequency:

5.8GHz +/- 75MHz

Microwave Power:

<0.2mW

Max Detection Range:

26 ft diameter at 16 ft mounting height

Detection Angle:

About 30 to 150 degrees

Remote Control Accessory:

Adjust settings using remote control (catalog# MVSREM). Only available with 0-10V dimming driver options. [Remote control available here.](#)

Dimensions

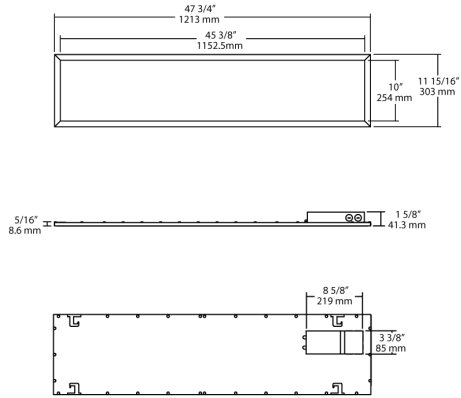

Features

Direct Connect to the Lightcloud Blue mobile app via Bluetooth, no Gateway or Hub required

Use mobile device to configure features for On/Off Control, Dim Level, Schedules, Scenes, and more.

Meets Luminaire Level Lighting Control (LLLC) requirements

Integrated passive infrared or microwave sensor for added savings







Use mobile device to configure sensor settings for sensitivity, timeout and actions.

Includes emergency battery backup

Coverage Pattern

MVS - Occupancy Sensor Detection Pattern

Features

-  24-hour daylight monitoring dawn/dusk sensor
-  Tri-level dimming control based upon occupancy (*also known as corridor function*)
-  1-10V dimming control method
-  One-touch daylight learning via remote control
-  Zero crossing detection circuit reduces in-rush current and prolongs relay life
-  Loop-in and loop-out terminal for efficient installation



Ordering Matrix

Family	Size		Wattage	Color Temp	Dimming (standard)	Control Options	Other Options
EZPAN	1X4	-	30	N	/D10	/LCBS/MVS	/E2
	2X4 = 2' x 4' 2X2 = 2' x 2' 1X4 = 1' x 4'		17 = 17W 30 = 30W 40 = 40W 50 = 50W	Blank = 5000K Cool N = 4000K Neutral YN = 3500K Warm Neutral Y = 3000K Warm	/D10 = 0-10V Dimming	Blank = No Sensor /LC = Lightcloud® Controller /LCB = Lightcloud® Blue Enabled /LCBS = Lightcloud® Blue Enabled w/ PIR Sensor /LCBS/MVS = Lightcloud® Blue Enabled w/ MVS Sensor	Blank = None /E2 = Battery Backup