

Technical Specifications (continued)

Lightcloud

Lightcloud Blue Sensor Installed:

Occupancy, vacancy, and closed loop daylight harvesting in one versatile sensor. In addition control any fixture in your Lightcloud Blue integrated/embedded networked lighting luminaire-level control system. LLLC - capable of switching, 0-10V dimming, power/energy monitoring. Can also be used to extend the range of the Lightcloud Blue utilizing a "BLE Mesh" network communication protocols. The Lightcloud Blue sensor can be attached to the fixture provided an unobstructed view of the coverage area is available.

DLC system - N1XMLOEATBA

[Learn more about Lightcloud.](#)

LED Characteristics

LEDs:

Long-life, high-efficacy, surface-mount LEDs

Electrical

Driver:

Constant Current, Class 2, 50/60 Hz, 120-277V, 120V: 0.25A, 208V: 0.20A, 240V: 0.13A, 277V: 0.12A

THD:

7.76% at 120V, 9.61% at 277V

Power Factor:

98.9% at 120V, 90.8% at 277V

Dimensions

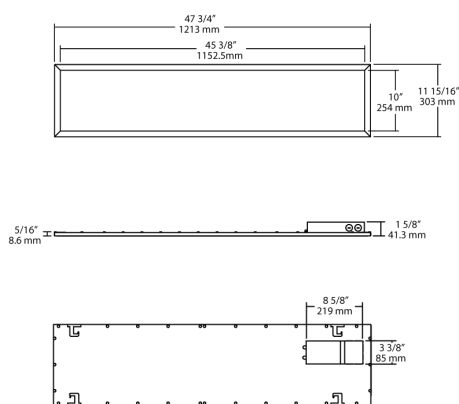

Features

Direct Connect to the Lightcloud Blue mobile app via Bluetooth, no Gateway or Hub required

Use mobile device to configure features for On/Off Control, Dim Level, Schedules, Scenes, and more.

Meets Luminaire Level Lighting Control (LLLC) requirements

Integrated passive infrared or microwave sensor for added savings

Use mobile device to configure sensor settings for sensitivity, timeout and actions.

Emergency battery backup options available

Ordering Matrix

Family	Size		Wattage	Color Temp	Dimming (standard)	Control Options	Other Options
EZPAN	1X4	-	30		/D10	/LCBS	
	2X4 = 2' x 4' 2X2 = 2' x 2' 1X4 = 1' x 4'		17 = 17W 30 = 30W 40 = 40W 50 = 50W	Blank = 5000K Cool N = 4000K Neutral YN = 3500K Warm Neutral Y = 3000K Warm	/D10 = 0-10V Dimming	Blank = No Sensor /LC = Lightcloud® Controller /LCB = Lightcloud® Blue Enabled /LCBS = Lightcloud® Blue Enabled w/ PIR Sensor /LCBS/MVS = Lightcloud® Blue Enabled w/ MVS Sensor	Blank = None /E2 = Battery Backup