

Technical Specifications (continued)

Lightcloud

Lightcloud Blue Sensor Installed:

Occupancy, vacancy, and closed loop daylight harvesting in one versatile sensor. In addition control any fixture in your Lightcloud Blue integrated/embedded networked lighting luminaire-level control system. LLLC - capable of switching, 0-10V dimming, power/energy monitoring. Can also be used to extend the range of the Lightcloud Blue utilizing a "BLE Mesh" network communication protocols. The Lightcloud Blue sensor can be attached to the fixture provided an unobstructed view of the coverage area is available. DLC system - N1XMLOEATBA
[Learn more about Lightcloud.](#)

LED Characteristics

LEDs:

Long-life, high-efficacy, surface-mount LEDs

Sensor Specifications

Capacitance Load:

400VA at 120VAC, 800VA at 230VAC, 1000VA at 277VAC

Operating Temperature:

-20°C to +60°C (-4°F to +140°F)

Relay:

Zero-cross relay

Maximum Mounting Height:

16.4 feet

Customizable Detection Area:

10, 50, 75 or 100%

Time Delay:

5s, 30s, 1min, 5min, 10min, 20min, 30min

Cut Off Period:

0s, 10s, 1min, 5min, 10min, 30min, 1hr, Bi-Level

Cut-Off Dimming level:

10, 20, 30, 50%

Cut-Off Power:

Less than 1W

Daylight Threshold:

About .2-5 fc for disabled

Sensor Principle:

High Frequency

Microwave Frequency:

5.8GHz +/- 75MHz

Microwave Power:

<0.2mW

Max Detection Range:

26 ft diameter at 16 ft mounting height

Detection Angle:

About 30 to 150 degrees

Remote Control Accessory:

Adjust settings using remote control (catalog# MVSREM). Only available with 0-10V dimming driver options. [Remote control available here.](#)

Electrical

Driver:

Constant Current, Class 2, 50/60 Hz, 120-277V, 120V: 0.20A, 208V: 0.10A, 240V: 0.10A, 277V: 0.10A

THD:

8.77% at 120V, 5.71% at 277V

Power Factor:

98.8% at 120V, 89.3% at 277V

Dimensions

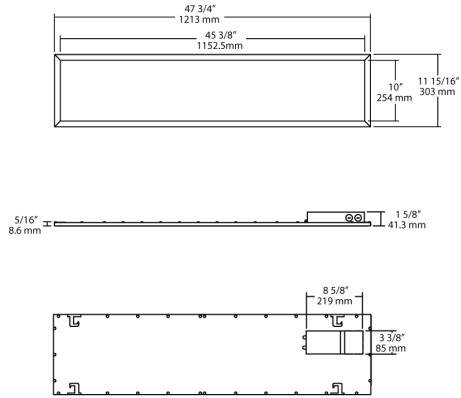







Features

- Direct Connect to the Lightcloud Blue mobile app via Bluetooth, no Gateway or Hub required
- Use mobile device to configure features for On/Off Control, Dim Level, Schedules, Scenes, and more.
- Meets Luminaire Level Lighting Control (LLLC) requirements
- Integrated passive infrared or microwave sensor for added savings
- Use mobile device to configure sensor settings for sensitivity, timeout and actions.
- Emergency battery backup options available

Coverage Pattern

MVS - Occupancy Sensor Detection Pattern

Features

-  24-hour daylight monitoring dawn/dusk sensor
-  Tri-level dimming control based upon occupancy (*also known as corridor function*)
-  1-10V dimming control method
-  One-touch daylight learning via remote control
-  Zero crossing detection circuit reduces in-rush current and prolongs relay life
-  Loop-in and loop-out terminal for efficient installation

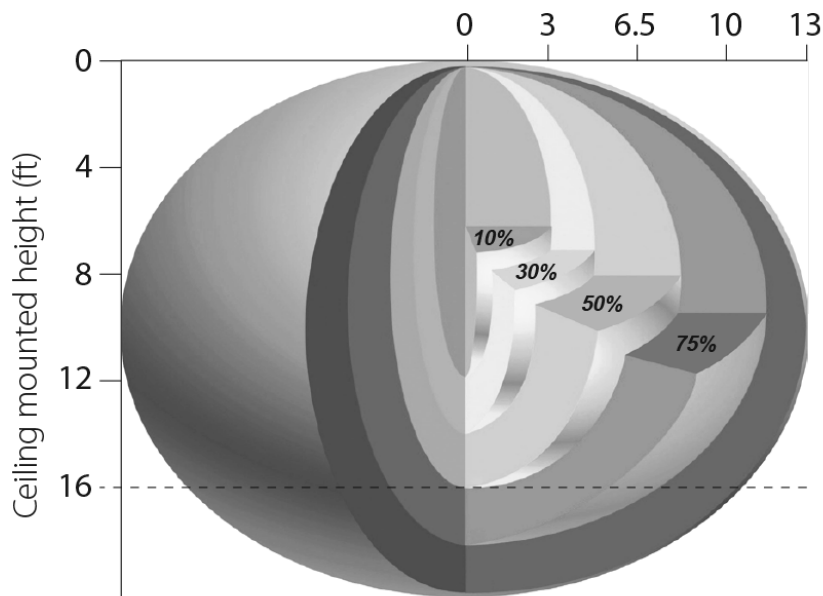

Ordering Matrix

Family	Size		Wattage	Color Temp	Dimming (standard)	Control Options	Other Options
EZPAN	1X4	-	17		/D10	/LCBS/MVS	
	2X4 = 2' x 4' 2X2 = 2' x 2' 1X4 = 1' x 4'		17 = 17W 30 = 30W 40 = 40W 50 = 50W	Blank = 5000K Cool N = 4000K Neutral YN = 3500K Warm Neutral Y = 3000K Warm	/D10 = 0-10V Dimming	Blank = No Sensor /LC = Lightcloud® Controller /LCB = Lightcloud® Blue Enabled /LCBS = Lightcloud® Blue Enabled w/ PIR Sensor /LCBS/MVS = Lightcloud® Blue Enabled w/ MVS Sensor	Blank = None /E2 = Battery Backup