



Project:	Type:
Prepared By:	Date:

Explosionproof junction box for wiring with cover tap it allows pendant fixture hanging.

Color: Silver gray

Weight: 3.0 lbs

### Technical Specifications

#### Construction

**Box Construction:**

Heavy wall castings. Precision machined surfaces.  
Four 1/4-20 screws fasten top to box.

**Box Capacity:**

20 cubic inches

**Finish:**

Polyester powder coating

**Hub Size:**

1/2" side hubs, 8 hole position

**Cover Tap:**

1/2"

#### Electrical

**Close-up Plugs:**

Aluminum slotted plugs with 6 full threads. One provided for each box hole.

#### Other

**Buy American Act Compliance:**

RAB values USA manufacturing! Upon request, RAB may be able to manufacture this product to be compliant with the Buy American Act (BAA). Please contact customer service to request a quote for the product to be made BAA compliant.



## Dimensions

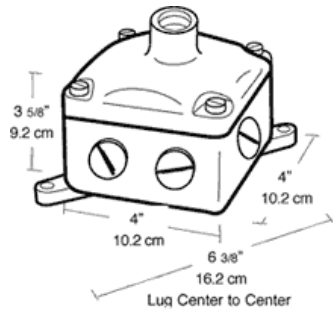

## Features

- Accessory reflectors and exit signs available
- Cast aluminum junction box also serves as a hanger box for pendant fixtures
- Heavy gauge die formed aluminum
- Reflectors with white polyester powder finish