

INSTRUCTIONS

DISK17 CCT Adjustable Installation

RAB®

RAB Lighting is committed to creating high-quality, affordable, well-designed and energy-efficient LED lighting and controls that make it easy for electricians to install and end users to save energy. We'd love to hear your comments. Please call the Marketing Department at 888-RAB-1000 or email: marketing@rablighting.com

**** DON'T TOSS IT—RECYCLE IT! MAKE THE SUSTAINABLE CHOICE BY RECYCLING THIS FIXTURE AT END OF LIFE WITH A LICENSED RECYCLING PROVIDER. ****



DISK17-4/BP



DISK17-6/BP

IMPORTANT

READ CAREFULLY BEFORE INSTALLING FIXTURE. RETAIN THESE INSTRUCTIONS FOR FUTURE REFERENCE.

RAB fixtures must be wired in accordance with the National Electrical Code and all applicable local codes. Proper grounding is required for safety. THIS PRODUCT MUST BE INSTALLED IN ACCORDANCE WITH THE APPLICABLE INSTALLATION CODE BY A PERSON FAMILIAR WITH THE CONSTRUCTION AND OPERATION OF THE PRODUCT AND THE HAZARDS INVOLVED.

WARNINGS:

- Risk of electrical shock. Disconnect power at fuse or circuit breaker before installing or servicing.
- To prevent early lamp failure, lamp should only be installed in operating environments ranging between -30°C and +40°C (-22°F and +104°F).
- No user serviceable parts inside. To avoid electrical shock do not disassemble product.
- Risk of fire or electric shock, LED Retrofit Kit installation requires knowledge of luminaires electrical systems. If not qualified, do not attempt installation. Contact a qualified electrician.
- Risk of fire or electric shock, install this kit only in luminaires that have the construction features and minimum dimensions shown in Figure 1 and where the input rating of the retrofit kit does not exceed the input rating of the luminaire.
- Do not make or alter any open holes in an enclosure of wiring or electrical components during kit installation
- To prevent wiring damage or abrasion, do not expose wiring to edges of sheet metal or other sharp objects.
- Installers should not disconnect existing wires from lampholder terminals to make new connections at lampholder terminals, instead installers should cut existing lampholder leads away from the lampholder and make new electrical connections to lampholder lead wires by employing applicable connectors.
- This retrofit kit is accepted as a component of a luminaire where the suitability of the combination shall be determined by authorities having jurisdiction.
- This device is not intended for use with emergency exits.
- This retrofit kits suitable for wet locations luminaires specified as below: Type Non IC; Type IC; Covered ceiling; Uncovered ceiling. Installers should examine all parts that are not intended to be replaced by the retrofit kit for damage and replace any damaged parts prior to installation of the retrofit kit.

NOTE 1: This equipment has been tested and found to comply with the limits for a Class B digital device, pursuant to part 15 of the FCC Rules. These limits are designed to provide reasonable protection against harmful interference in a residential installation. This equipment generates, uses and can radiate radio frequency energy and, if not installed and used in accordance with the instructions, may cause harmful interference to radio communications. However, there is no guarantee that interference will not occur in a particular installation. If this equipment does cause harmful interference to radio or television reception, which can be determined by turning the equipment off and on, the user is encouraged to try to correct the interference by one or more of the following measures:

- Reorient or relocate the receiving antenna.
- Increase the separation between the equipment and receiver.
- Connect the equipment into an outlet on a circuit different from that to which the receiver is connected.
- Consult the dealer or an experienced radio/TV technician for help.

NOTE 2: Any changes or modifications to this unit not expressly approved by the party responsible for compliance could void the user's authority to operate the equipment

WHAT'S IN THE BOX

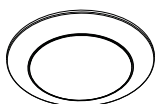

Disk (1)



Screws (2)



Nuts (2)

TOOLS NEEDED

Installation with J-BOX

A screwdriver is needed for installation.

INSTRUCTIONS

DISK17 CCT Adjustable Installation



RAB Lighting is committed to creating high-quality, affordable, well-designed and energy-efficient LED lighting and controls that make it easy for electricians to install and end users to save energy. We'd love to hear your comments. Please call the Marketing Department at 888-RAB-1000 or email: marketing@rablighting.com

**** DON'T TOSS IT—RECYCLE IT! MAKE THE SUSTAINABLE CHOICE BY RECYCLING THIS FIXTURE AT END OF LIFE WITH A LICENSED RECYCLING PROVIDER. ****

DIMENSIONAL DRAWINGS

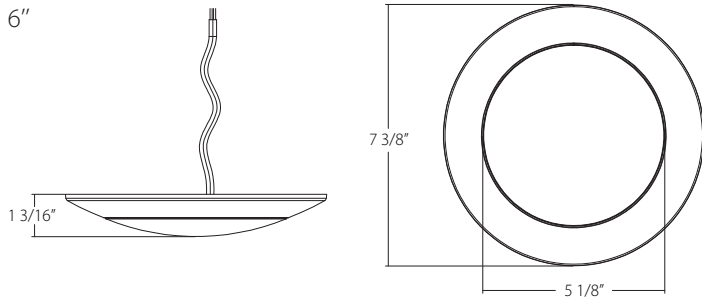
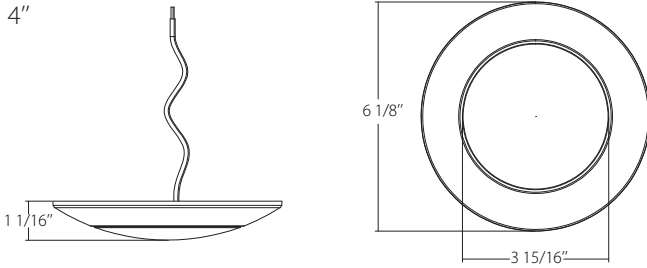

MIN. LAMP COMPARTMENT DIMENSIONS

Installation with J-BOX

J-box Min. Volume - 12.56 in³, Min Length: 3.2in, Height: 1.57in
Compatible with standard J-box

INSTALLATION WITH J-BOX

DISK17-4 compatible with 2.75" J-BOX.

DISK17-6 compatible with 2.75" and 3.5" J-BOX.

1. Make sure power is turned off and the J-Box is affixed to the ceiling surface. (Fig.1)

Fig: 1

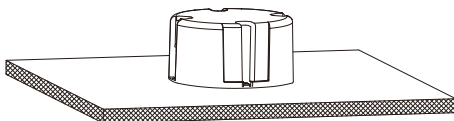

INSTALLATION WITH J-BOX (cont'd)

2. Connect the luminaire to supply wires with wire nut. Wire nut live (black) wire with Disk black wire and wire nut neutral (white) wire with Disk white wire. Wire nut ground (green) with Disk ground (green) wire. (Fig.2)

Fig: 2

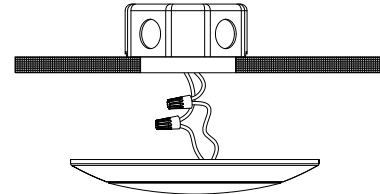

3. Remove lens by turning counter clockwise to unlock. (Fig.3)

Fig: 3

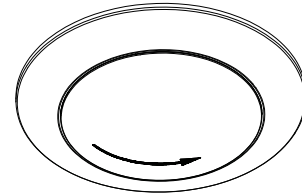

4. Select desired color temperature. (Fig.4)

Fig: 4

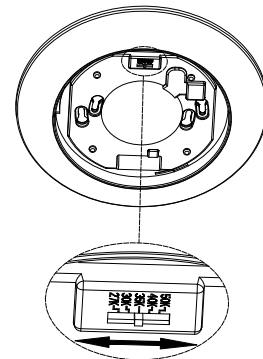

5. Safely place all wires into the junction box, mount luminaire to the junction box by tightening the screws through the keyhole slots. (Fig.5)

Fig: 5

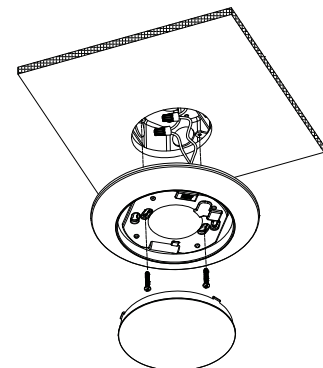

INSTRUCTIONS

DISK17 CCT Adjustable Installation



RAB Lighting is committed to creating high-quality, affordable, well-designed and energy-efficient LED lighting and controls that make it easy for electricians to install and end users to save energy. We'd love to hear your comments. Please call the Marketing Department at 888-RAB-1000 or email: marketing@rablighting.com

**** DON'T TOSS IT—RECYCLE IT! MAKE THE SUSTAINABLE CHOICE BY RECYCLING THIS FIXTURE AT END OF LIFE WITH A LICENSED RECYCLING PROVIDER. ****

INSTALLATION WITH J-BOX *(cont'd)*

6. Replace lens and twist clockwise to lock. *(Fig.6)*

Fig: 6

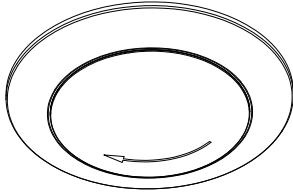

7. Caulk around the mounting surface edge with silicone sealant. *(Fig.7)*

Fig: 7

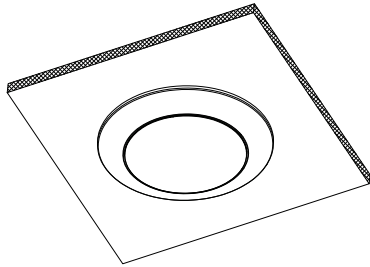

Note: These instructions do not cover all details or variations in equipment nor do they provide for every possible situation during installation, operation or maintenance.