

INSTRUCTIONS

Flush Mount



RAB Lighting is committed to creating high-quality, affordable, well-designed and energy-efficient LED lighting and controls that make it easy for electricians to install and end users to save energy. We'd love to hear your comments. Please call the Marketing Department at 888-RAB-1000 or email: marketing@rablighting.com

CRVFAD-XXR-XX-9CCT-UNVT-BN/EM



IMPORTANT

READ CAREFULLY BEFORE INSTALLING FIXTURE. RETAIN THESE INSTRUCTIONS FOR FUTURE REFERENCE.

RAB fixture must be wired in accordance with the National Electrical Code and all applicable local codes.

THIS PRODUCT MUST BE INSTALLED IN ACCORDANCE WITH THE APPLICABLE INSTALLATION CODE BY A PERSON FAMILIAR WITH THE CONSTRUCTION AND OPERATION OF THE PRODUCT AND THE HAZARDS INVOLVED.

TO PREVENT ELECTRICAL SHOCK, POWER SHOULD BE TURNED OFF AT THE FUSE BOX BEFORE INSTALLATION.

SAFETY WARNINGS:

Read all product labels and directions.

- Installation should be performed only by a qualified electrician in accordance with the National Electrical Code and relevant local codes.
- **WARNING** – To prevent wiring damage or abrasion, do not expose wiring to edges of sheet metal or other sharp objects.
- **INSTALLATION SHOULD ONLY BE PERFORMED AFTER POWER TO THE FIXTURE HAS BEEN DISCONNECTED.**
- These instructions shall be included on an information sheet packaged with each unit.
- This device complies with Part 15 of the FCC Rules. Operation is subject to the following two conditions:
(1) this device may not cause harmful interference, and (2) this device must accept any interference received, including interference that may cause undesired operation.

This equipment has been tested and found to comply with the limits for a Class B digital device, pursuant to part 15 of the FCC Rules. These limits are designed to provide reasonable protection against harmful interference in a residential installation. This equipment generates, uses and can radiate radio frequency energy and, if not installed and used in accordance with the instructions, may cause harmful interference to radio communications. However, there is no guarantee that interference will not occur in a particular installation. If this equipment does cause harmful interference to radio or television reception, which can be determined by turning the equipment off and on, the user is encouraged to try to correct the interference by one or more of the following measures:

- Reorient or relocate the receiving antenna.
- Increase the separation between the equipment and receiver.
- Connect the equipment into an outlet on a circuit different from that to which the receiver is connected.
- Consult the dealer or an experienced radio/TV technician for help.

WHAT'S IN THE BOX

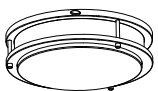

Fixture (1)

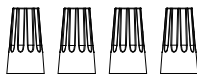

Nuts (4)



Screws (2)

INSTALLATION WITH J-BOX

1. Make sure the **POWER IS TURNED OFF** at the source to the J-box in which you are installing the product.
2. Loosen screws counter clockwise and disassemble the surface mount cover. (Fig.1)

Fig: 1

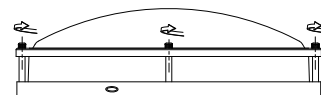

TOOLS NEEDED

Installation with J-BOX

A screw driver is needed for installation

RAB Lighting is committed to creating high-quality, affordable, well-designed and energy-efficient LED lighting and controls that make it easy for electricians to install and end users to save energy. We'd love to hear your comments. Please call the Marketing Department at 888-RAB-1000 or email: marketing@rablighting.com

INSTALLATION WITH J-BOX (cont'd)

3. Select desired CCT. (Fig.2)

Fig: 2

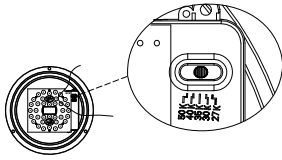

4. Insert screws into J-Box holes, leaving about 15mm of space between the screw heads and J-Box. (Fig.3)

Fig: 3



5. Wire the surface mount, white-white, black-black, brown connect to wall switch output wire. Two ground wires (Green and Yellow&Green) connect input ground wire. Once wire connections are made, secure each with a wire nut. (Fig.4)

Fig: 4

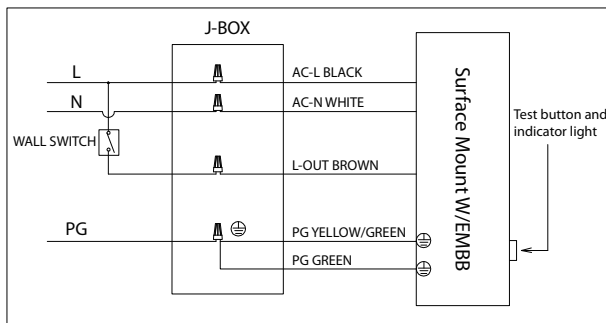

6. Lift fixture to ceiling and carefully tuck wires into J-Box. Align keyholes on surface mount with screws, then twist fixture until the screws engage the narrow end of the keyholes. Tighten screws to secure. (Fig.5)

Fig: 5

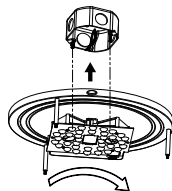

INSTALLATION WITH J-BOX (cont'd)

7. Reassemble the lamp cover. (Fig.6) Tighten screws clockwise. (Fig.7) Caulk around the mounting surface edge with silicone sealant. (Fig.8)

Fig: 6

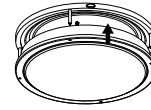

Fig: 7

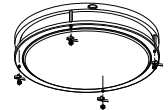
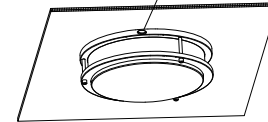

Fig: 8

Test button and indicator light



Emergency Application		
Wattage	Time	Initial Lumen
4w	90 minutes	320lm

Note:

- The red light indicator will be on during charging. Press the test button while charging or after charging, the indicator light will be off and the fixture should operate at reduced lumen output. This means the emergency function is operating as normal.
- The emergency driver will be fully charged after 24 hours of continuous charging. In case of a power failure, the Surface Mount fixture will operate for 90 minutes on emergency battery power.
- When the Surface Mount is only powered by the emergency battery, press the test button twice continuously if need to turn it off. When the mains power is connected, it will automatically return to the normal mode.

TESTING PROCEDURES

- Press the test button to cut the power to the AC driver and switch the system to emergency mode.
- Release the test button to return to normal mode.
- Switch off the circuit breaker to simulate a full power outage.

Monthly

- Ensure that the test button light is illuminated.
- Conduct a 30-second discharge test by depressing the test button.
- The LED load should operate at reduced output.

Annually

- Allow a 24-hour charge before conducting test.
 - Ensure that the test button light is illuminated.
 - Conduct a full 90-minute discharge test.
 - The unit should operate as intended for the duration of the test.
- "Written records of the testing shall be kept by the owner for inspection by the authority having jurisdiction."

SERVICING SHOULD BE PERFORMED BY QUALIFIED PERSONNEL.

Note: These instructions do not cover all details or variations in equipment nor do they provide for every possible situation during installation, operation or maintenance.