

INSTRUCTIONS

FA Commercial Downlight with Emergency Backup



RAB Lighting is committed to creating high-quality, affordable, well-designed and energy-efficient LED lighting and controls that make it easy for electricians to install and end users to save energy. We'd love to hear your comments. Please call the Marketing Department at 888-RAB-1000 or email: marketing@rablighting.com

CRLEDFA-xR-xxS-9CCT-UNV-WS/E

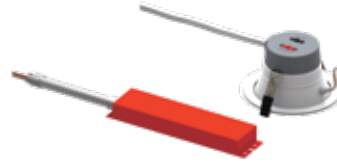

IMPORTANT

READ CAREFULLY BEFORE INSTALLING FIXTURE. RETAIN THESE INSTRUCTIONS FOR FUTURE REFERENCE.

RAB fixtures must be wired in accordance with the National Electrical Code and all applicable local codes. Proper grounding is required for safety. THIS PRODUCT MUST BE INSTALLED IN ACCORDANCE WITH THE APPLICABLE INSTALLATION CODE BY A PERSON FAMILIAR WITH THE CONSTRUCTION AND OPERATION OF THE PRODUCT AND THE HAZARDS INVOLVED.

WARNINGS:

- Risk of electrical shock. Disconnect power at fuse or circuit breaker before installing or servicing.
- To prevent early lamp failure, lamp should only be installed in operating environments ranging between -20°C and 40°C (-4°F and 104°F).
- No user serviceable parts inside. To avoid electrical shock do not disassemble product.
- Risk of fire or electric shock. LED Retrofit Kit installation requires knowledge of luminaires electrical systems. If not qualified, do not attempt installation. Contact a qualified electrician.
- Risk of fire or electric shock. Install this kit only in luminaires that have the construction features and minimum dimensions shown in these instructions and where the input rating of the retrofit kit does not exceed the input rating of the luminaire.
- Do not make or alter any open holes in an enclosure of wiring or electrical components during kit installation
- To prevent wiring damage or abrasion, do not expose wiring to edges of sheet metal or other sharp objects.
- Installers should not disconnect existing wires from lampholder terminals to make new connections at lampholder terminals. Instead installers should cut existing lampholder leads away from the lampholder and make new electrical connections to lampholder lead wires by employing applicable connectors.
- The retrofit kit is accepted as a component of a luminaire where the suitability of the combination shall be determined by authorities having jurisdiction. Product must be installed by a qualified electrician in accordance with the applicable and appropriate electrical codes. The installation guide does not supersede local national regulations for electrical installations.
- This device is not intended for use with emergency exits.
- Caution - risk of fire. Consult a qualified electrician to ensure correct branch circuit conductor.
- Minimum 90°C supply conductors
- Installers should examine all parts that are not intended to be replaced by the retrofit kit for damage and replace any damaged parts prior to installation of the retrofit kit.

This equipment has been tested and found to comply with the limits for a Class A digital device, pursuant to part 15 of the FCC Rules. These limits are designed to provide reasonable protection against harmful interference when the equipment is operated in a commercial environment. This equipment generates, uses, and can radiate radio frequency energy and, if not installed and used in accordance with the instruction manual, may cause harmful interference to radio communications. Operation of this equipment in a residential area is likely to cause harmful interference in which case the user will be required to correct the interference at his own expense.

WHAT'S IN THE BOX



Downlight (1)

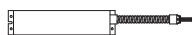

Emergency Driver (1)



Wire Nuts (5)



Lumi Sticker (1)



Template (1)



MC connector (1)

Shall be marked on the retrofit luminaire where readily visible by the user during normal maintenance including relamping.

TOOLS NEEDED

This LED Recessed Kit requires very few tools for installation. A screwdriver and a pair of wirecutters will help to install the downlight to a JBox or housing.

INSTRUCTIONS

FA Commercial Downlight with Emergency Backup



RAB Lighting is committed to creating high-quality, affordable, well-designed and energy-efficient LED lighting and controls that make it easy for electricians to install and end users to save energy. We'd love to hear your comments. Please call the Marketing Department at 888-RAB-1000 or email: marketing@rablighting.com

OPTIONAL ACCESSORIES

Goof Ring

Visit rablighting.com for the downlight accessory compatibility lists.

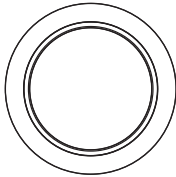

DL6-8GOOF/R/P/CRLEDFA

For use with 8" ceiling hole applications

DL8-10GOOF/R/P/CRLEDFA

For use with 10" ceiling hole applications

DL8-12GOOF/R/P/CRLEDFA

For use with 12" ceiling hole applications

Plate

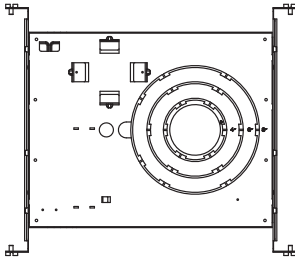

DLPLATE/C3468R/NB

Mounting plate with nailer bar

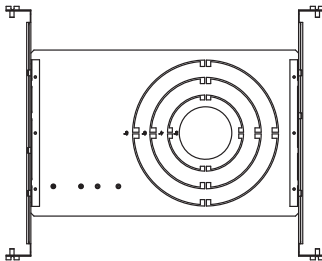

DLPLATE/WFR3468/NB

Mounting plate with nailer bar

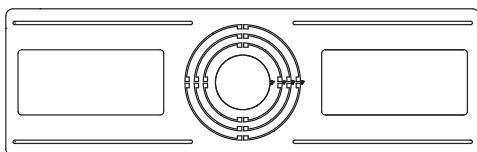

DLPLATE/WFR3456

6" Mounting Plate (only compatible with 6" downlight)

OPTIONAL ACCESSORIES (cont'd)

Frame

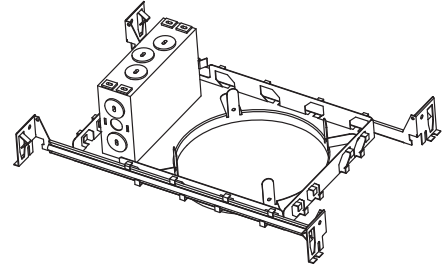

DLFRAME/C6R

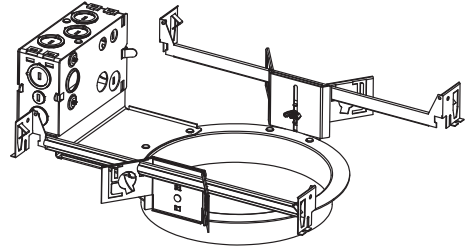

DLFRAME/C8R

Color Trims

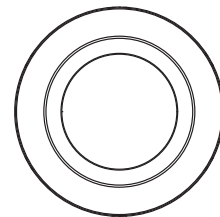

DLTRIM/CRLEDFA6R-BS

DLTRIM/CRLEDFA6R-BNS

DLTRIM/CRLEDFA6R-BRS

Compatible with 6" models

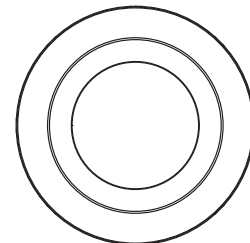

DLTRIM/CRLEDFA8R-BS

DLTRIM/CRLEDFA8R-BNS

DLTRIM/CRLEDFA8R-BRS

Compatible with 8" models

INSTRUCTIONS

FA Commercial Downlight with Emergency Backup



RAB Lighting is committed to creating high-quality, affordable, well-designed and energy-efficient LED lighting and controls that make it easy for electricians to install and end users to save energy. We'd love to hear your comments. Please call the Marketing Department at 888-RAB-1000 or email: marketing@rablighting.com

INSTALLATION WITH EXISTING FRAME

1. Use the template included in the box to cut a hole in the ceiling. (Fig.1)

Fig: 1

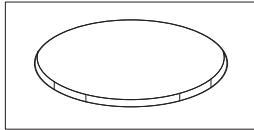

2. Select desired lumen output and color temperature using switches on the top of the downlight. (Fig.2)

Fig: 2

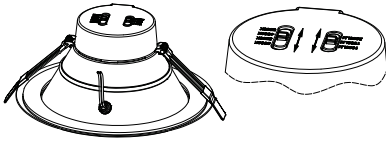

3. Open the knock-out on the J-box, the connector of the emergency driver is clamped onto the J-box. (Fig.3)

Fig: 3

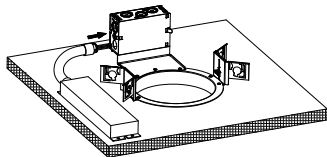

4. Connect the downlight conduit cable to a J-box. (Fig.4)

Fig: 4

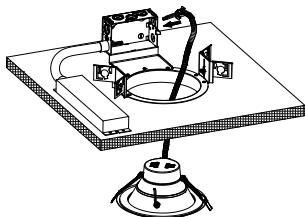

INSTALLATION WITH EXISTING FRAME (cont'd)

5. Refer to the wiring diagram (Fig 8 in P6) to connect the test switch with emergency driver. (Fig.5)

Fig: 5

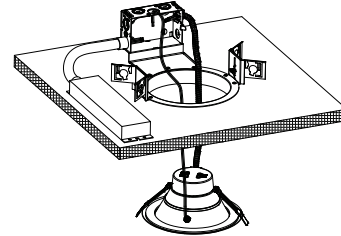

6. Refer to the wiring diagram (Fig 8 in P6) to connect downlight with emergency driver. (Fig.6)

Fig: 6

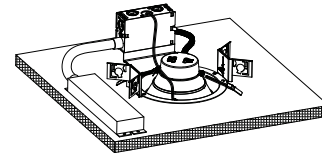

7. Push until the trim sits flush against the ceiling. (Fig.7)

Fig: 7

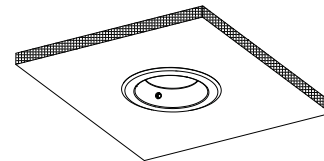

Note: These instructions do not cover all details or variations in equipment nor do they provide for every possible situation during installation, operation or maintenance.

INSTRUCTIONS

FA Commercial Downlight with Emergency Backup



RAB Lighting is committed to creating high-quality, affordable, well-designed and energy-efficient LED lighting and controls that make it easy for electricians to install and end users to save energy. We'd love to hear your comments. Please call the Marketing Department at 888-RAB-1000 or email: marketing@rablighting.com

MINIMUM LUMINAIRE DIMENSION

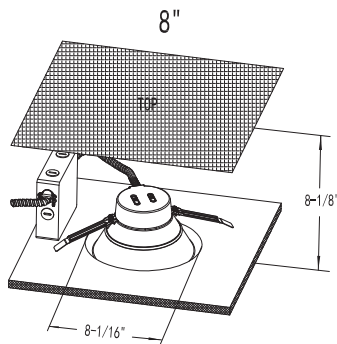
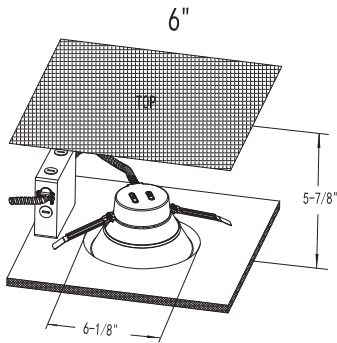

DIMENSIONAL DRAWINGS

CRLEDFA-6R-16S-9CCT-UNV-WS/E

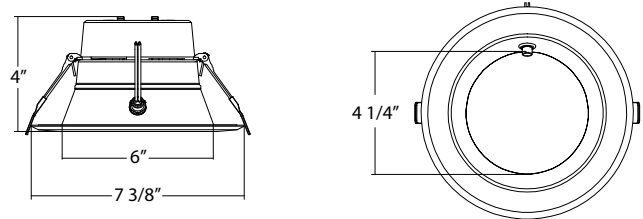

Driver

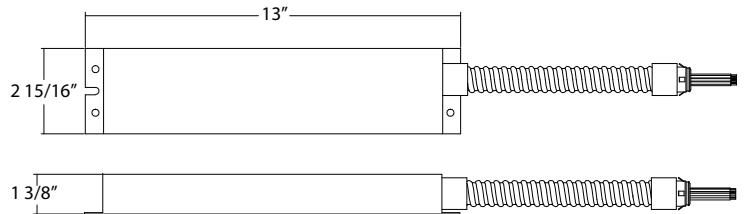

CRLEDFA-8R-22S-9CCT-UNV-WS/E

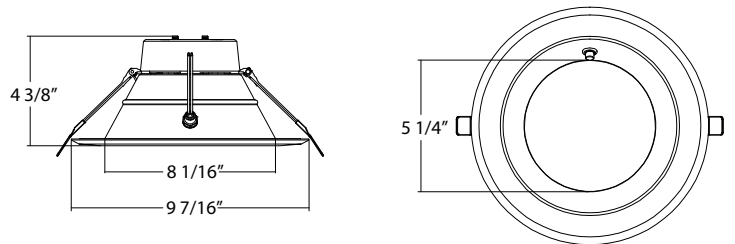

Driver

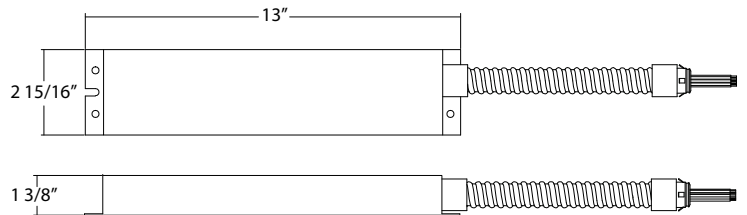

INSTRUCTIONS

FA Commercial Downlight with Emergency Backup



RAB Lighting is committed to creating high-quality, affordable, well-designed and energy-efficient LED lighting and controls that make it easy for electricians to install and end users to save energy. We'd love to hear your comments. Please call the Marketing Department at 888-RAB-1000 or email: marketing@rablighting.com

DRI-21-EMGR-DC-D10



IMPORTANT

READ CAREFULLY BEFORE INSTALLING FIXTURE. RETAIN THESE INSTRUCTIONS FOR FUTURE REFERENCE.

RAB fixtures must be wired in accordance with the National Electrical Code and all applicable local codes. Proper grounding is required for safety. THIS PRODUCT MUST BE INSTALLED IN ACCORDANCE WITH THE APPLICABLE INSTALLATION CODE BY A PERSON FAMILIAR WITH THE CONSTRUCTION AND OPERATION OF THE PRODUCT AND THE HAZARDS INVOLVED.

WARNING:

AC power must be off before proceeding with assembly or installation of emergency driver.

CAUTION: DO NOT USE OUTDOORS.

CAUTION: DO NOT MOUNT NEAR GAS OR ELECTRONIC HEATERS.

CAUTION: EQUIPMENT SHOULD BE MOUNTED IN LOCATIONS AND AT HEIGHTS WHERE IT WILL NOT BE SUBJECTED TO TAMPERING BY UNAUTHORIZED PERSONNEL.

CAUTION: THE USE OF ACCESSORY EQUIPMENT NOT RECOMMENDED BY THE MANUFACTURER MAY CAUSE AN UNSAFE CONDITION.

CAUTION: DO NOT USE THIS EQUIPMENT FOR OTHER THAN ITS INTENDED USE.

CAUTION: Use with grounded, UL Listed, damp location rated fixtures and case should be grounded.

CAUTION: The equipment is intended for ordinary locations and for permanent installation into one or more listed emergency luminaires.

IMPORTANT: The products are produced with built-in batteries, which could be stocked for one year at most without being used.

If clients keep them for more than one year, the batteries may be damaged. This is not covered in the warranty.

NOTE: 1. Please install this product properly by "licensed electrician".

2. Damp or wet location installation is OK.

3. Keep away from flammable materials in an area with good heat dissipation.

4. Please charge the battery consistently for >24 hours for the first time usage to activate the whole battery cells of discharging/charging duration.

SUITABLE FOR BELOW LAMP

1. 8-80W LED products with 0-10V dimming capability, and ensure the LED product system power below 20W when dimming to 1V.
2. 8-21W LED products without 0-10V dimming capability also can be used.

LED INDICATOR

1. Red stable: charging mode or fully charged.
2. Red off: main power off or discharging mode.
3. 2 second slow flashing (compatibility test standby mode): represents that the battery is at a low voltage and needs charging.

TEST SWITCH

Emergency Kit will go into emergency mode if test switch is pressed when main supply is on, while it will go into charging mode if test switch is not pressed.

FAILURE MODE

0.5 second fast flashing-represents failure mode (*No battery or open circuit in emergency mode or LED load wattage is higher than nominal emergency power*).

Note: These instructions do not cover all details or variations in equipment nor do they provide for every possible situation during installation, operation or maintenance.

INSTRUCTIONS

FA Commercial Downlight with Emergency Backup



RAB Lighting is committed to creating high-quality, affordable, well-designed and energy-efficient LED lighting and controls that make it easy for electricians to install and end users to save energy. We'd love to hear your comments. Please call the Marketing Department at 888-RAB-1000 or email: marketing@rablighting.com

CLEAR FAILURE MODE

Check wiring, solve the problem and connect mains power. Then press test button and go to compatibility test, LED indicator will be permanent red if compatibility test passes, meanwhile failure mode is cleared.

TESTING PROCEDURES

1. Press the test button to cut the power to the AC driver and switch the system to emergency mode.
2. Release the test button to return to normal mode.
3. Switch off the circuit breaker to simulate a full power outage.

Monthly

1. Ensure that the test button light is illuminated.
2. Conduct a 30-second discharge test by depressing the test button.
3. The LED load should operate at reduced output.

Annually

1. Allow a 24-hour charge before conducting test.
2. Ensure that the test button light is illuminated.
3. Conduct a full 90-minute discharge test.
4. The unit should operate as intended for the duration of the test.

"Written records of the testing shall be kept by the owner for inspection by the authority having jurisdiction."

SERVICING SHOULD BE PERFORMED BY QUALIFIED PERSONNEL.

WIRING DIAGRAM

Fig: 8

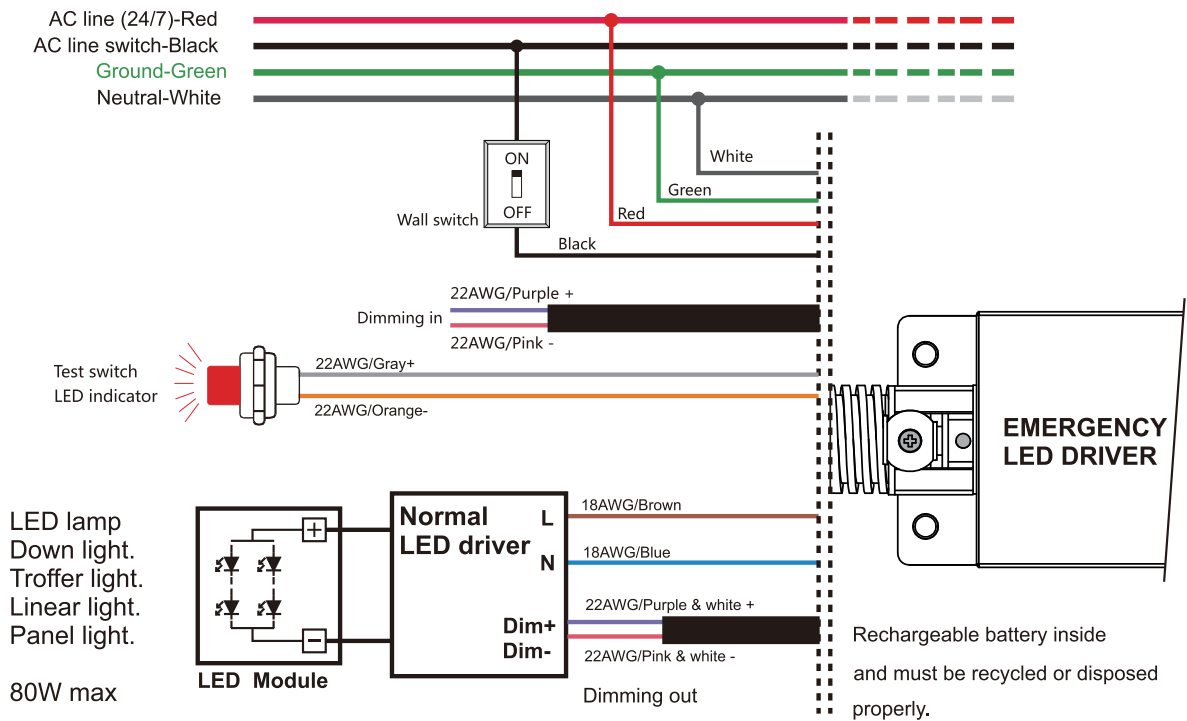

Easy Answers

rablighting.com
Visit our website for product info

Tech Help Line
Call our experts: 888 722-1000

e-mail
Answered promptly - sales@rablighting.com

Free Lighting Layouts
Answered online or by request

RAB WARRANTY: RAB's warranty is subject to all terms and conditions found at rablighting.com/warranty.