

CLED™ INSTALLATION INSTRUCTIONS

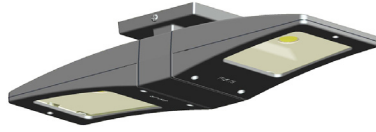

CLED2X10
CLED2X13



CLED2X20
CLED2X26

Thank you for buying RAB lighting fixtures. Our goal is to design the best quality products to get the job done right. We'd like to hear your comments. Call the Marketing Department at 888-RAB-1000, or email: marketing@rabweb.com

IMPORTANT

READ CAREFULLY BEFORE INSTALLING FIXTURE. RETAIN THESE INSTRUCTIONS FOR FUTURE REFERENCE.

RAB fixtures must be wired in accordance with the National Electrical Code and all applicable local codes. Proper grounding is required for safety. THIS PRODUCT MUST BE INSTALLED IN ACCORDANCE WITH THE APPLICABLE INSTALLATION CODE BY A PERSON FAMILIAR WITH THE CONSTRUCTION AND OPERATION OF THE PRODUCT AND THE HAZARDS INVOLVED.

**WARNING: Make certain power is OFF before installing or maintaining fixture.
No user servicable parts inside.**

CLED2X10, CLED2X13

Mount the CLED to a recessed Junction Box as follows:

1. Mount the **Adaptor Plate** to **Junction Box** (not supplied) with hardware provided.
2. Attach **Tether** to fixture and **Adaptor Plate** with the screw provided.
3. Wire fixture as shown in the wiring section. Do not use CLED2X10 on 277V circuit.
4. Align the **Canopy** on fixture to **Adaptor Plate** and tighten (2) **Side Screws** through the **Canopy** to the **Adaptor Plate**.

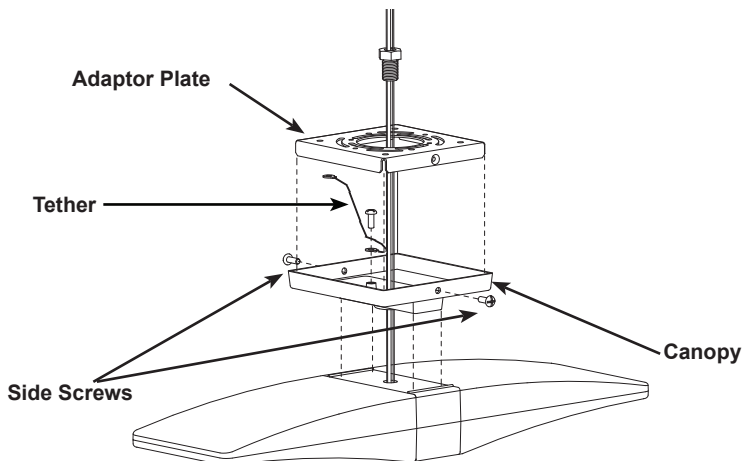

CLED2X20, CLED2X26

Mount the CLED to a recessed Junction Box as follows:

1. Mount the **Adaptor Plate** to **Junction Box** (not supplied) with hardware provided.
2. Attach **Tether** to fixture and **Adaptor Plate** with the screw provided.
3. Wire fixture as shown in the wiring section.
4. Align the **Canopy** on fixture to **Adaptor Plate** and tighten (2) **Side Screws** through the **Canopy** to the **Adaptor Plate**.

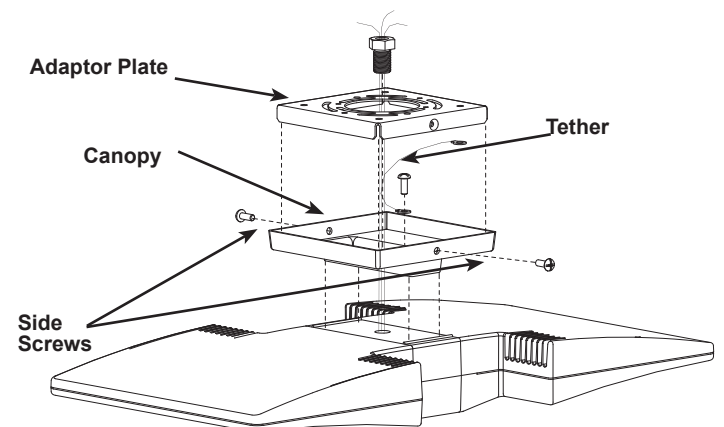

CLED™ INSTALLATION INSTRUCTIONS**WIRING**

Universal voltage driver permits operation at 50 on 60Hz and the following voltages:

CLED 2X10: 120 Volts - 240 Volts
CLED 2X13: 120 Volts - 277 Volts
CLED 2X20: 120 Volts - 277 Volts
CLED 2X26: 120 Volts - 277 Volts

1. Connect the black fixture lead to the (+) LINE supply lead.
2. Connect the white fixture lead to the (-) COMMON supply lead.
3. Connect the bare copper Ground wire from fixture to supply ground.

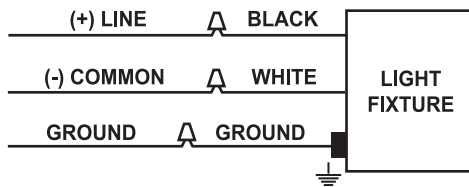
**CLEANING & MAINTENANCE**

CAUTION: Be sure fixture temperature is cool enough to touch. Do not clean or maintain while fixture is energized.

1. Clean glass lens with non-abrasive glass cleaning solution.
2. Do not open fixture to clean the LED. Do not touch the LED.

ACCESSORIES

GDWPL1P Polyshield for 10W & 13W
Order 2 per CLED or "/P" for factory installed

GDWPL2P. Polyshield for 20W
Order 2 per CLED or "/P" for factory installed

No wire guard is available at this time

OPTIONS

Suffix "Y" = Warm 2800K to 3000K LED
Suffix "N" = Neutral 4000K LED, on 2X13 & 2X26

The design of the CLED is protected by U.S. patent D608,040; D615,689 and patents pending in Canada, China, Taiwan and Mexico.

Note: These instructions do not cover all details or variations in equipment nor do they provide for every possible situation during installation, operation or maintenance.

Mini Sensor

Outdoor Motion Sensor
Installation Manual

**It's easy
to add
motion detection
to outdoor
lights!**



RAB[®]
LIGHTING

Contents:

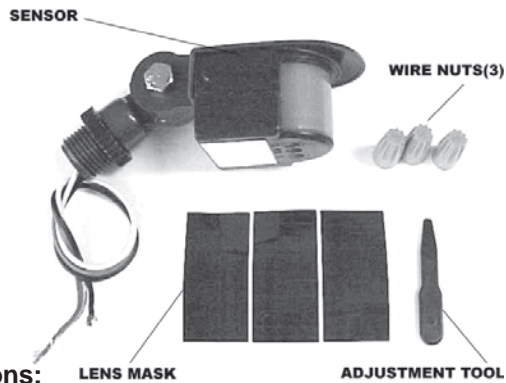

Specifications:

Relay On/Off Model:
500 watts Incandescent or
250 watts Fluorescent @ 120 volts

Voltage:
120 Volts AC

Power Consumption:
One watt



UL Listing:
Raintight Photoelectric Switch
Suitable for wet locations.

Time Adjustment:
5 seconds to 15 minutes

Quick Test Time:
5 second test time for fast installation.
Works day or night.

Detection Zone:
Full 180° by 30'

“No Hands” Auto Testing:
Auto mode starts after 3 minutes of
testing. No adjustment needed.

Built for Severe Conditions:
Double weatherproofing for long life.

Photoelectric Control:
Deactivates lights during daylight.
Fully adjustable for 24 hour operation
or custom applications.

Vandal Resistant Lens:
Hard lens resists casual vandalism.

Case Construction:
Precision molded Lexan®

Color Matched Lens:
Dark lens with black units.
White lens with white units.

Surge Protection:
Withstands up to 3000 Volts

Manual Override:
Double flip wall switch logic prevents
activation by short power outages.
Resets to auto at dawn.
No extra wiring needed.

LED Detection Indicator:
Glows red day and night for
“on-guard” deterrence.

RF Immunity:
Circuits fully shielded for maximum
radio frequency immunity.

Why RAB Sensors are BEST for You?

Smaller is better!

Mini Sensor uses state-of-the-art surface mount technology (SMT), just like cellular phones and beepers. SMT gives you more reliability, greater RF immunity, and a compact sensor that can fit neatly where others cannot.

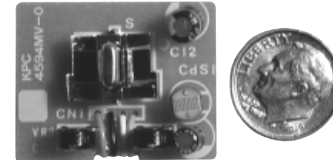

Wider is better!

The wide 180° view detects movement along the entire side of a building with only one compact sensor. It will detect people as they exit or enter. It takes several conventional sensors to get the same coverage.

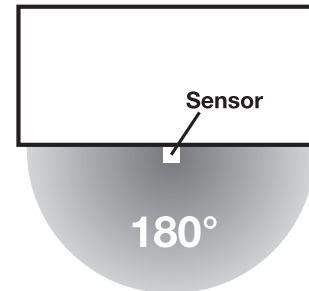

Molded is better!

No leaky gaskets or bug hotels with Mini Sensor. The hard lens is molded as part of the case. It's vandalproof, rainproof, bugproof and absolutely sealed.

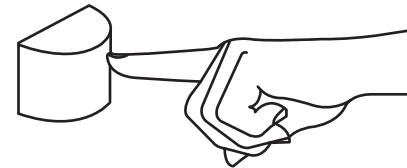

Caution

- All wiring **MUST** comply with local electrical codes and should be installed by qualified electrician.
- Read entire Installation Manual before proceeding.

TURN OFF POWER BY REMOVING POWER FUSE OR TURNING OFF CIRCUIT BREAKER BEFORE INSTALLATION.

- Total lighting load must not exceed: 5 amps, 500 watts incandescent quartz when sensor is used remotely (250 watts when floodlights are mounted to sensor) or 250 watt fluorescent at 120 volts. To switch more wattage, an electrician can install an additional relay.
- Line Carrier Remote Control Systems such as X-10, Leviton or Radio Shack are incompatible with sensors and cause false activations.
- Do not install on circuits feeding motor loads such as kitchen appliances, HVAC equipment, washer/ dryer or garage door openers.
- Sensor functions best when movement is across its detection pattern, not towards the sensor.

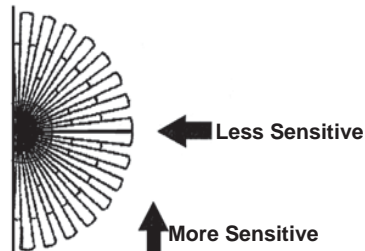

- Mount 6'-10' high for optimum range and direction.

Assembly and Wiring

1. Screw the threaded arm of the sensor into the center hold of the mounting plate. Sensors can be wall or ceiling mounted.
2. If mounting on the same cover plate as floodlight(s), screw the threaded arm(s) of each floodlight into the mounting plate. Leave the locknuts and arm screws loose until ready to aim. Always mount the sensor below lights.
3. Bring power leads and sensor leads into box.
4. Attach ground wire(s) to outlet box grounding screw.
5. Strip 1/2" of insulation from all leads. Connect as shown in Wiring Diagram.
6. Twist on wire nuts. Secure with electrical tape.
7. Align gasket to ensure proper seal. Fasten mounting plate with sensor with two screws provided. Use silicone sealant around all openings, if necessary.
8. Screw in light bulbs. Turn on power.
9. Conduct Walk Test to adjust sensor response.

Basic Wiring Diagram

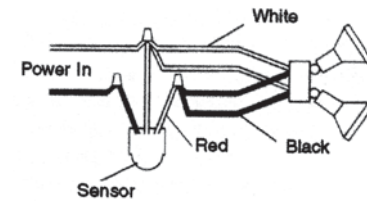

Wiring Diagrams

To override sensor with a manual switch

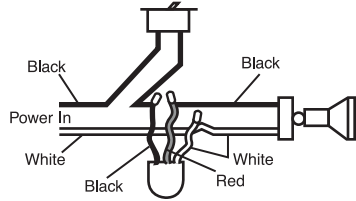

To switch more than rated load (Relay model only)

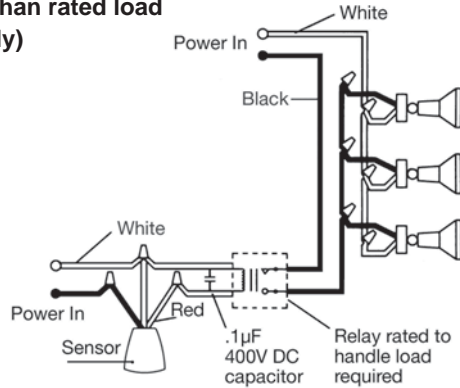

Multiple sensors:

Wiring more than one sensor together is recommended only for the experienced installer because it becomes difficult to troubleshoot. Single sensors that control their own lights pinpoint movement more accurately and operate better.

Power Quality:

Sensors should not be installed on a circuit that also feeds motor loads such as HVAC equipment, kitchen appliances, or garage door openers. If voltage varies significantly from 120 volts, sensors may malfunction.

How Does RAB's Mini Sensor Work?

The Mini Sensor infrared sensor "sees" small temperature changes caused by the motion of people or cars within its detection zone and turns on lights automatically. It welcomes visitors and may deter intruders.

How long do the lights stay on?

Lights remain on as long as there is movement within the Detection Zone. Once the zone is vacated, lights can be adjusted to remain on approximately 5sec up to 15 minutes.

Will the sensor detect animals?

Mini Sensor may detect large animals. Having animals trigger the sensor can give property a "lived-in" look. You can limit animal detection by placing opaque weatherproof tape on the lower part of the lens or using the bottom mask on the Lens Mask Kit provided.

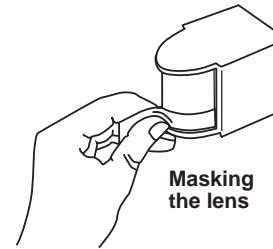

What does Manual Override do?

Keep lights on by flipping the wall switch two times within 5 seconds. Sensor resets to auto mode at dawn. No extra wiring needed.

How are the Time, Sensitivity and Photocell adjusted?

TimeControl: Sets the time that lights will remain on after the Detection Zone is vacated from approximately 5 seconds to 15 minutes. Use the adjustment tool provided to turn clockwise to increase the time. Factory Setting: 5-8 minutes.

Photocell Control: For night only operation, use the tool provided or a small screwdriver to turn the Photocell Control all the way counter-clockwise (to the moon symbol). For operation in low level lights, turn the knob all the way clockwise (to the sun symbol). Adjust counterclockwise to have the sensor come on later at dusk, clockwise to have it come on earlier. Turning photocell control will show when the sensor "thinks" the current ambient light level = night, because the lights will turn on. Factory setting : Night Only

Sensitivity: Increases or decreases the responsiveness and range of the sensor.

Control Panel:

Turn controls gently using adjustment tool provided. Do not force past stops.

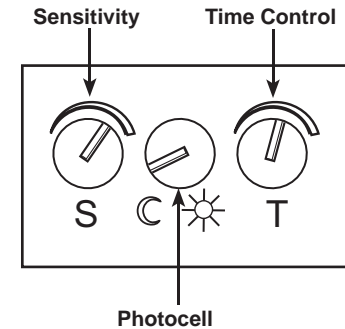

Picking A Location

Location Considerations:

- Choose a location from which the sensor can “see” all the paths of movement that will be illuminated by its lights.
- Mini Sensor may be wall or ceiling mounted.
- Sensor functions best when the direction of expected movement is across its detection pattern, not towards the sensor.
- If wall mounting, locate 6-10’ high for optimum range and detection. Lower mounting height will reduce range. Sensor must be below and as far as possible away from lights. If ceiling mounted be sure there are no lights below sensor.

Detection Pattern:

- The sensor has a “Double Look Down” Lens with one “Look Out” zone and two “Look Down” zones, for excellent detection both at long and close range.
- Detection extends out a maximum of 30 feet and is 180° wide.
- To reduce the Detection Pattern length, aim the sensor down
- To reduce Detection Pattern width, mask the sides of the lens with the Lens Mask Kit provided or opaque weatherproof tape.
- If sensor is mounted by a doorway at the top of stairs, be aware that the elevated mounting height may extend the sensors range.
- As distance from the sensor increases, it will take more movement to be detected. For instance, at 10 feet, a half step will be enough, while at 30 feet, several steps will be necessary.

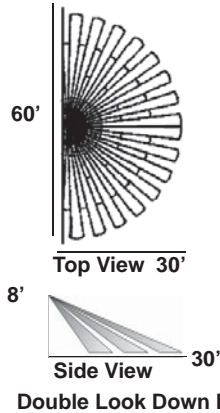

Aiming and Walk Testing

Test Period:

The sensor has a 3 minute Test Period which allows it to be aimed and walk tested day or night.

- For the first 30 seconds, the lights will be turned on. During this time, test that all fixtures and lamps function properly.
- For the next 3 minutes, the sensor will keep lights on for 5 seconds each time it detects movement in its Detection Zone. The sensor will change to Automatic Mode after the 3 minute Test Period.
- If another 3 minute Test Period is desired, turn the power off for at least 10 seconds and back on again.

Walk Test:

The purpose of the Walk Test is to check and adjust the coverage pattern.

1. Aim the sensor approximately to cover the area you desire.
2. Start outside the Detection Zone and walk across the zone until the lights go on. As distance from the sensor increases, it will take more movement to be detected. For instance, at 10 feet, a half step will be enough, while at 30 feet, several steps will be necessary.

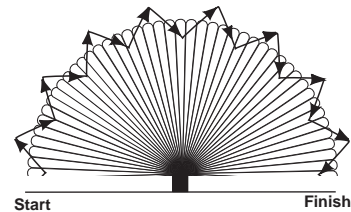

3. To reduce range, use the lens masks provided or tilt sensor down. Repeat steps #2 and #3 until you are satisfied with the coverage.
4. The Time Control is factory set between 5-8 minutes. This period starts after the movement in the Detection Zone ceases. If less time is desired, turn the time control counterclockwise. For more time, turn the control clockwise.
5. The sensor is factory set for night only operation. To obtain full operation 24 hours per day, turn the Photocell Control fully clockwise to the sun symbol. Intermediate settings will allow the sensor to operate earlier or later at dusk.
6. Your sensor is ready for operation. See the Technical Tips pages if additional help is needed.

Control Panel:

Turn controls gently using the adjustment tool provided. Do not force past stops.

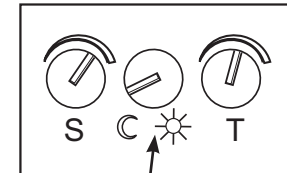

Photocell
Turn to moon symbol for night only

Turn to sun symbol for 24 hour operation (lights turn on night and day)

**Technical Tips:
Lights Do Not Turn Off**

1. Make sure sensor is not aimed at something that would move or change temperature such as waving branches, water, air conditioners, windows or heating vents - even on neighboring property. You can test for infrared sources in the area by placing a box or bag over the sensor. Put sensor into Test Mode. After the initial 30 seconds of the lights being on, lights should stay off. Wave your hand inside the bag in front of sensor. Lights should go on and then time out. If sensor operates properly when covered, check items 2-6.

Problem: Sensor is triggered by unwanted movement or heat source.

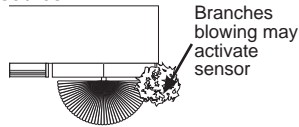

Solution: Tilt sensor (Pg.8) or mask lens in the direction of the source. Move sensor or source.

2. Make sure sensor is mounted firmly and does not move even slightly when touched. If it moves, tighten all screws.
3. Make sure that Mini Sensor is not mounted on an unstable object such as a tree or a pole that will move in the wind.
4. Was sensor wired hot? If so, circuitry may have been damaged.
5. Make sure sensor is not aimed within 30 feet of a road.

Problem: Passing cars activate sensor.

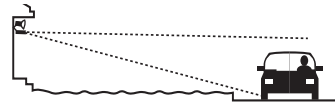

Solution: A 20' safety zone between the sensor and road is recommended to avoid activation from passing cars. You may tilt sensor down (Pg.8) or mask top of sensor lens to reduce range

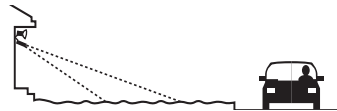
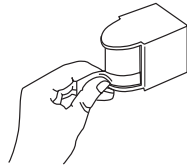

6. Make sure heat from lights is not triggering sensor. Make sure the sensor is below and as far as possible away from lights.

Tips above apply only if the lights are staying on in high full wattage mode.

**Technical Tips:
Range appears limited**

1. Check that the sensor is level from side to side and pointed at the area you desire. If unit is tilted, part of the Detection Zone may be high in the air over people's heads.

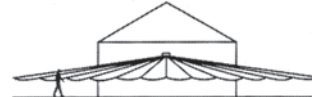

Solution: Position sensor exactly level from side to side.

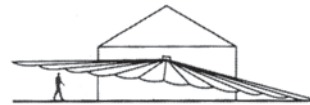

2. Check that the sensor is not mounted too high. If mounted above 20 feet, much of the usable range will be lost.

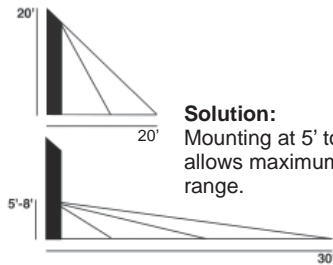

Solution: Mounting at 5' to 8' allows maximum range.

3. If sensor is painted, make sure there is no paint on the lens and that the lens paint mask is removed.

4. Check that movement is not directly towards sensor. Sensor will see movement across its pattern more quickly. To fix, move the sensor.

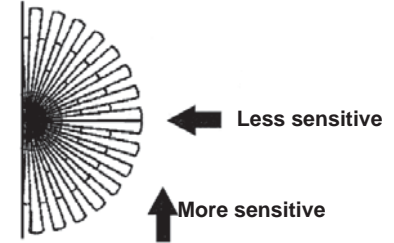

5. Check that movement far away and directly towards sensor is not entirely within one Detection Pattern finger.

Problem: Sensor will not detect until movement crosses from one finger into a second finger.

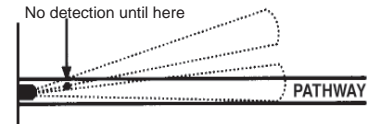

Solution: "Micro Adjust" sensor by opening lens cover and tilting sensor 1/16". This small adjustment may move the zones to allow earlier detection.

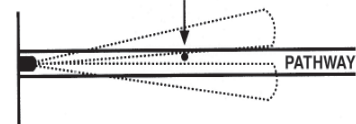

Technical Tips: Lights Do Not Turn On

1. Check that lamps and fixtures work. Compare wiring to the Wiring Diagram in this manual. Check that the power is on.
2. If installing during daylight, remember that the sensor will provide a 3 minute Test Period after power is turned on. After 3 minutes, the sensor will switch to Automatic Mode and will not work during daylight if the Photocell Control is turned to or near the night only position (fully counter clockwise to the moon symbol).

If you require another 3 minute Test Period, turn the power off for at least 10 seconds and back on again.

If you require the sensor to operate both in low level light and at night, turn the Photocell Control knob clockwise to the sun symbol.
3. Check that lights from other sources, such as adjacent porch lights, garden lights, streetlights or lights from inside the house are not in the sensor's view. See #1 under "Lights Turn Off Too Quickly".
4. Was sensor wired hot? If so, circuitry may have been damaged.
5. If sensor is painted, make sure there is no paint on the lens and that the lens paint mask is removed.

Lights Turn Off Too Quickly

1. Check if sensor is being "tricked" by reflected light. If lights shine or reflect into the photocell, (located behind the lens), the unit will go on briefly and turn off thinking it is daytime.

Problems:

Lights reflect into photocell or lights shine directly into photocell.



Solution: Adjust Photocell Control slightly clockwise, toward the sun symbol. This allows the sensor to function in brighter ambient light conditions. Alternatively, move the lights or mask the lens in the direction of the lights or reflections. If the problem persists, it may be necessary to increase the length of the sun shield over the sensor using weatherproof tape or some other material.

2. Check if "R" lamps, "A" lamps or self-ballasted PL lamps are being used in a non-enclosed lampholder that can be "seen" by the sensor. If so, switch to reflector PAR floodlight lamps or Quartz floods so the sensor is not affected by stray light. If using PAR floodlights, consider using lower wattage, energy saving lamps.

Self ballasted compact fluorescent lamps may cause the sensor to cycle on and off.

Technical Tips: Lights Turn On and Off Incorrectly

1. Make sure the sensor is installed on its own dedicated circuit free of motor loads such as HVAC equipment, kitchen appliances or garage door openers.
2. It is not recommended to wire sensors in parallel. More than one sensor wired together makes them difficult to troubleshoot. Disconnect multiple sensors and test separately.
3. Keep all people completely out of the detection pattern to make sure the sensor is not detecting them.
4. Make sure sensor is located below and as far as possible from its lights. Heat from the lights may trigger the sensor.

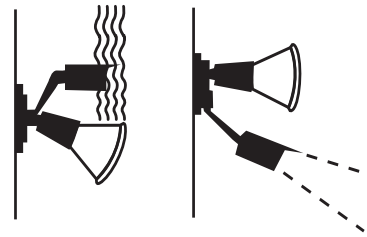

Solution: Move sensor below and away from the lights.

5. Make sure lights are not visible from or reflecting back into sensor. Check for white or reflective surfaces close to the sensor.

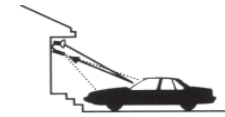

Solution: Aim sensor away from lights and reflective objects or mask the lens in the direction of the light or reflection.

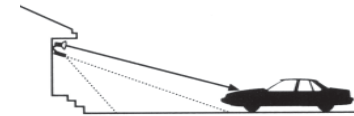

6. Heavy rain, snow or high winds may activate the sensor occasionally.

Solution: Reduce sensitivity control settings, mount in a more protected area and/or mask the lens if this is a constant problem.

7. Make sure sensor is not aimed within 30' of a road or sidewalk. Passing cars will activate sensor.

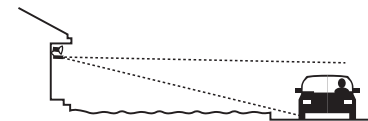

Solution: Mask the top of the lens to reduce Detection Pattern Length.

8. Self ballasted PL lamps may cause cycling (on-off).
9. Check solutions 1,2,3,5, & 6 under "Lights Do Not Turn Off" (Page 10).

**Technical Tips:
Lights Turn On For Unknown Reasons**

1. Lights may turn on occasionally during rain, snow and windstorms because the sensor is detecting changes in temperature. If this is a constant problem, mount the sensor in a more protected area.
2. Tilt the sensor lower - it may be seeing distant objects moving.
3. You may not be aware that animals have triggered sensor. Check sensor aiming to reduce nuisance triggering or mask the lower part of the lens with opaque weatherproof tape.

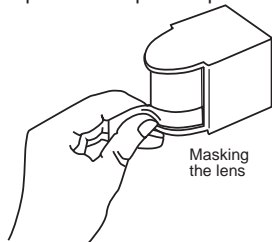

4. The sensor may turn on occasionally during voltage surges.
5. A possible source of "mysterious" sensor activations are strong local radio signals. Check for nearby CB, Ham, VHF radio transmitters or Cellular telephones. The sensor may be activated, but will not be permanently impaired by these signals.

Check other solutions mentioned under on pages 12 &13.



Limited Warranty

Your Mini Sensor will be promptly replaced or repaired, at our option, if it proves to be defective in workmanship or materials within 5 years of purchase.

For repair or replacement, return the product freight prepaid and insured to :
RAB Lighting
170 Ludlow Avenue
Northvale, NJ 07647

The product should be packed carefully. Please include your sales receipt and a description of the problem.

If the sensor is out of warranty or damage is unrelated to its original manufacture, return your unit freight prepaid to the address below. Please include a description of the problem and a check for \$20.00 (made out to RAB Lighting). We will repair or replace your unit promptly.

Under no circumstances shall RAB Lighting be liable for any incidental or consequential damages arising out of or in connection with the use or performance of this product or other indirect damages with respect to loss of property or revenue or cost of installation, removal or re-installation. This warranty gives you specific legal rights and you may also have other rights which vary from state to state. Mini Sensor is designed to detect people or cars in the detection area. It should not be construed as a theft or crime prevention device. RAB does not accept responsibility for any damages resulting from intrusion or other crimes.

**Toll Free
Technical Assistance**

If you need technical assistance, please do the following:

1. Re-read the Technical Tips sections of this manual.
2. Call the Tech Help Line at 888 RAB-1000, 8AM to 6PM Eastern Time M-F and we will be glad to help you. Before you call, please have the following information handy:
 - a) Catalog number of your unit;
 - b) Wattage, types and locations of lights connected to the sensor;
 - c) The electrical circuit on which the sensor is installed. What else does it feed? How is the sensor power switched?
 - d) Serial Number (4 digits) on the back of the sensor.
 - e) This installation Manual

Note: RAB Lighting cannot give electrical wiring instructions by phone. Please consult a qualified electrician.

RAB® Easy Installation & Product Help

RAB®
LIGHTING
© 2011 RAB LIGHTING Inc.
Northvale, New Jersey 07647 USA

Tech Help Line
Call our experts
888 RAB-1000

Toll Free Fax
Send a fax to RAB
888 RAB-1232

rabweb.com
Visit our website
for product info

e-mail
Answered promptly
sales@rabweb.com