

INSTRUCTIONS

CYLINDER INSTALLATION

RAB®

RAB Lighting is committed to creating high-quality, affordable, well-designed and energy-efficient LED lighting and controls that make it easy for electricians to install and end users to save energy. We'd love to hear your comments. Please call the Marketing Department at 888-RAB-1000 or email: marketing@rablighting.com

Wall Mount

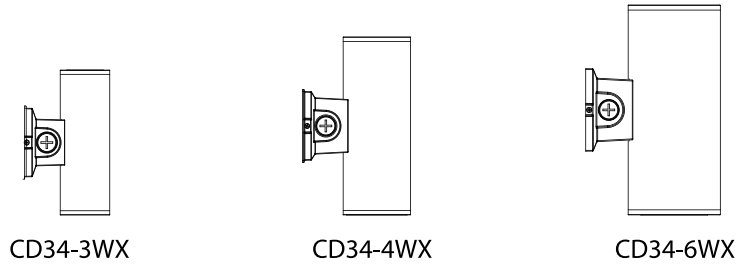

Ceiling Mount

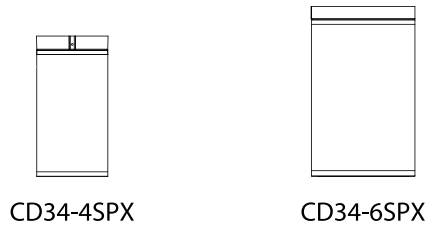

IMPORTANT

READ CAREFULLY BEFORE INSTALLING FIXTURE. RETAIN THESE INSTRUCTIONS FOR FUTURE REFERENCE.

RAB fixtures must be wired in accordance with the National Electrical Code and all applicable local codes. Proper grounding is required for safety. THIS PRODUCT MUST BE INSTALLED IN ACCORDANCE WITH THE APPLICABLE INSTALLATION CODE BY A PERSON FAMILIAR WITH THE CONSTRUCTION AND OPERATION OF THE PRODUCT AND THE HAZARDS INVOLVED.

WARNING:

- Make certain power is OFF before installing or maintaining fixture. No user serviceable parts inside.
- Fixture is suitable for wet location.
- Fixture must be mounted a minimum of 4 feet above ground level.

WALL MOUNT INSTALLATION

1. Fix the mounting plate on the wall. (Fig. 1)

Fig: 1

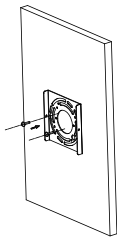

2. Connect the corresponding terminals according to the wiring diagram, connect L, N, and ground wires properly. (Fig. 2)

Fig: 2

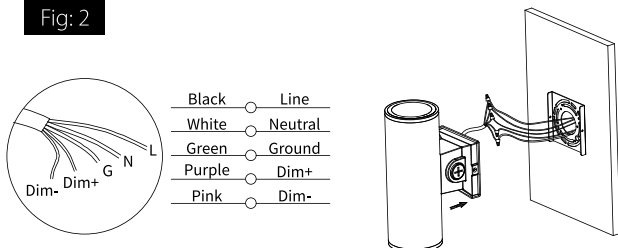

WALL MOUNT INSTALLATION (cont'd)

3. Fix the fixture with screws. (Fig. 3)

Fig: 3

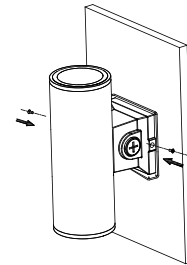

4. Fix the Mounting Plate on the J-Box. (Fig. 4)

Fig: 4

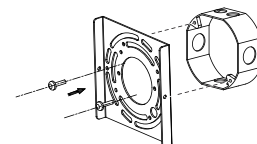

INSTRUCTIONS

CYLINDER INSTALLATION



RAB Lighting is committed to creating high-quality, affordable, well-designed and energy-efficient LED lighting and controls that make it easy for electricians to install and end users to save energy. We'd love to hear your comments. Please call the Marketing Department at 888-RAB-1000 or email: marketing@rablighting.com

WALL MOUNT INSTALLATION (cont'd)

5. Connect the corresponding terminals according to the wiring diagram, connect L, N, and ground wires properly. (Fig. 5)

Fig: 5

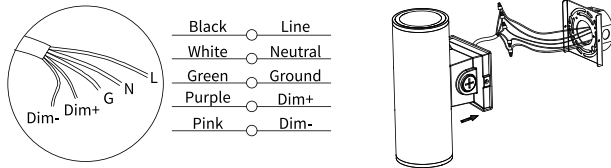

6. Fix the fixture with screws. (Fig. 6)

Fig: 6

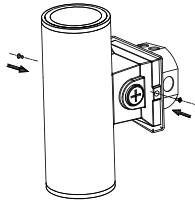

SELF-REPLACEABLE REFLECTORS

1. Twist off the top cover. (Fig. 7)

Fig: 7

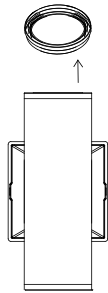

2. Twist off the top cover. (Fig. 8)

Fig: 8

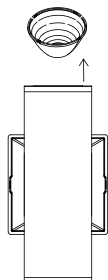

SELF-REPLACEABLE REFLECTORS (cont'd)

3. Replace with new reflector. (Fig. 9)

Fig: 9

Insert the bottom pole of the reflector into the hole on the bracket

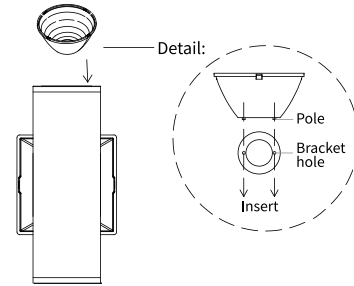

4. Screw on the top cover. (Fig. 10)

Fig: 10

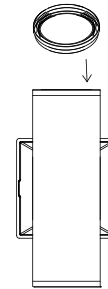

WATTAGE & CCT SELECTABLE GUIDANCE

Factory Default Setting:
 Watt: 36W/20W/10W CCT: 5000K Photocell: ON
 Light control: Full (Fig. 11)

Fig: 11

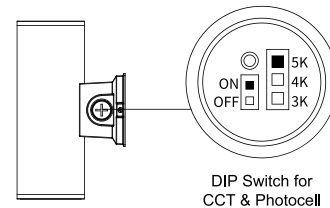

	3inch	4inch	6inch
XW =	10	20	36
YW =	8	16	28
ZW =	6	12	22

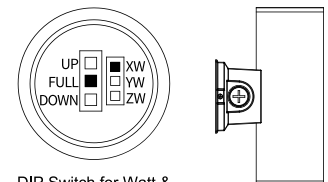

INSTRUCTIONS

CYLINDER INSTALLATION



RAB Lighting is committed to creating high-quality, affordable, well-designed and energy-efficient LED lighting and controls that make it easy for electricians to install and end users to save energy. We'd love to hear your comments. Please call the Marketing Department at 888-RAB-1000 or email: marketing@rablighting.com

CEILING MOUNT INSTALLATION

1. Adjust the length of the wire according to the actual needs. Select CCT and power according to the requirements. (Fig. 12)
Factory Default Setting:
Watt: 30W or 20W CCT: 5000K

Fig: 12

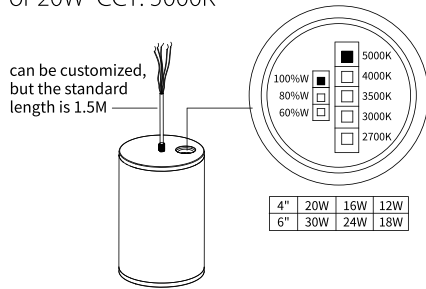

2. Secure the mounting plate to the fixture. (Fig. 13)

Fig: 13

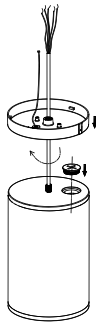

3. ① Fixed ceiling tray on the ceiling. ② Put on the fixing rope. ③ Connect the wire. (Fig. 14)

Fig: 14

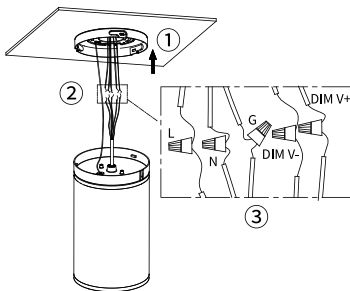

4. Rotate and snap the light onto the ceiling tray. (Fig. 15)

Fig: 15

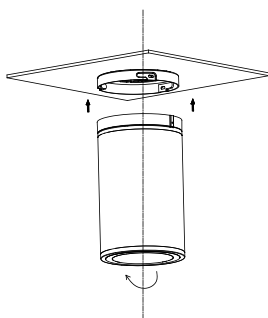

CEILING MOUNT INSTALLATION (cont'd)

5. Attach the fixing screws. (Fig. 16)

Fig: 16

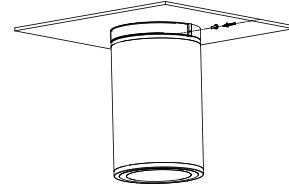

POLE INSTALLATION

1. Adjust the length of the wire according to the actual needs. Select CCT and power according to the requirements. (Fig. 17)

Fig: 17

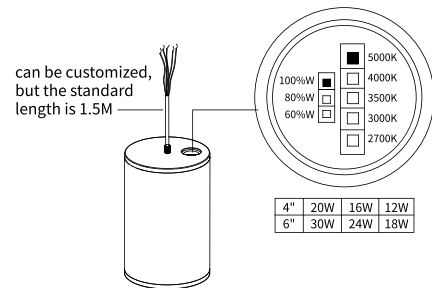

2. Pole and lamp body threaded connection. (Fig. 18)

Fig: 18

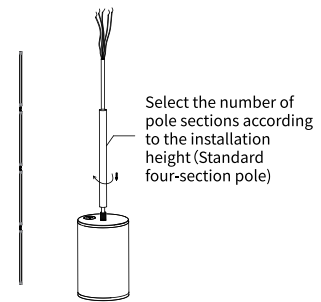

3. ① Install the hollow thread on the lamp panel. ② Rod and disc threaded connection. (Fig. 19)

Fig: 19

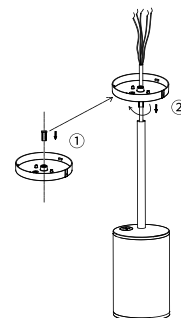

INSTRUCTIONS

CYLINDER INSTALLATION



RAB Lighting is committed to creating high-quality, affordable, well-designed and energy-efficient LED lighting and controls that make it easy for electricians to install and end users to save energy. We'd love to hear your comments. Please call the Marketing Department at 888-RAB-1000 or email: marketing@rablighting.com

POLE INSTALLATION (cont'd)

- ① Fixing the ceiling tray to the ceiling. ② Hang up safety rope. ③ Connect the wire. (Fig. 20)

Fig: 20

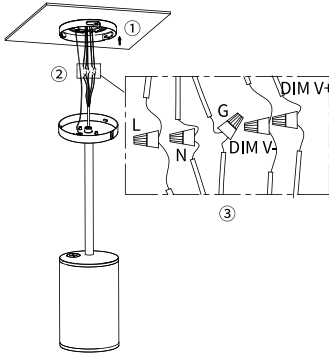

5. Rotate the lamp and attach it to the ceiling plate. (Fig. 21)

Fig: 21

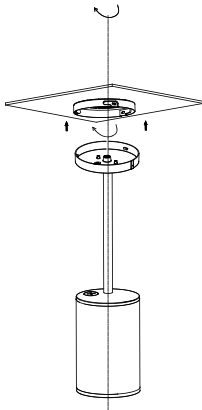

6. Install fixing screws. (Fig. 22)

Fig: 22

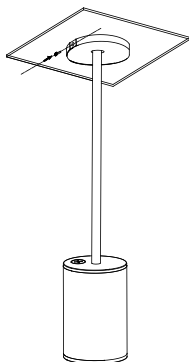

DOWNLIGHT PENDANT

1. Adjust the length of the wire according to the actual needs. Select CCT and power according to the requirements. (Fig. 23)

Fig: 23

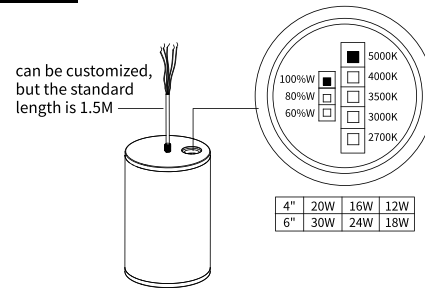

2. ① Nut connection. ② Nut to lower screw connection. (Fig. 24)

Fig: 24



3. ① Attach the hollow screws to the light panel. ② Nut to top screw connection. (Fig. 25)

Fig: 25

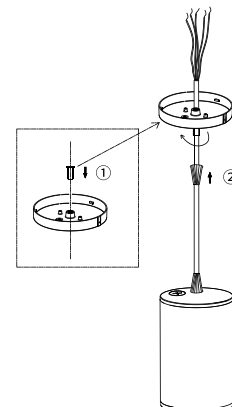

INSTRUCTIONS

CYLINDER INSTALLATION

RAB®

RAB Lighting is committed to creating high-quality, affordable, well-designed and energy-efficient LED lighting and controls that make it easy for electricians to install and end users to save energy. We'd love to hear your comments. Please call the Marketing Department at 888-RAB-1000 or email: marketing@rablighting.com

DOWNLIGHT PENDANT (cont'd)

1. Slip on the line buckle and adjust the length of the lanyard.
2. Fix ceiling tray on the ceiling.
3. Fix ceiling tray on the ceiling.
4. Connect the wire. (Fig. 26)

Fig: 26

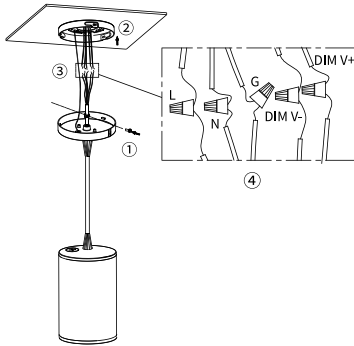

5. Rotate the lamp and attach it to the ceiling plate. (Fig. 27)

Fig: 27

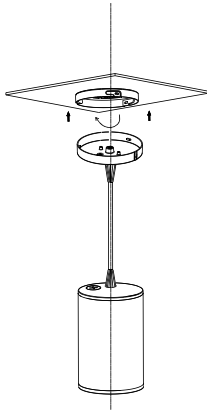

6. Install fixing screws. (Fig. 28)

Fig: 28

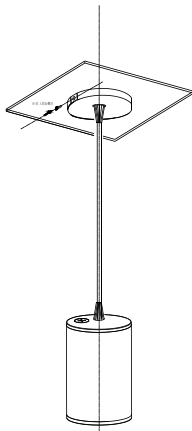

CLEANING & MAINTENANCE

CAUTION: Be sure fixture temperature is cool enough to touch.

Do not clean or maintain while fixture is energized.

1. Do not open fixture to clean the LED. Do not touch the LED.
2. Do not touch reflector.
3. Do not clean any fixture surface with wood-base cleaning material such as paper towels or tissues.

TROUBLESHOOTING

1. Check that the line voltage at the fixture is correct. Refer to wiring directions.
2. Is the fixture grounded properly?