

# INSTRUCTIONS

## 8" Recessed Commercial Downlight FA



RAB Lighting is committed to creating high-quality, affordable, well-designed and energy-efficient LED lighting and controls that make it easy for electricians to install and end users to save energy. We'd love to hear your comments. Please call the Marketing Department at 888-RAB-1000 or email: [marketing@rablighting.com](mailto:marketing@rablighting.com)

C8R229FAUNVW  
C8R339FAUNVW  
C8R559FAUNVW



### IMPORTANT

#### READ CAREFULLY BEFORE INSTALLING FIXTURE. RETAIN THESE INSTRUCTIONS FOR FUTURE REFERENCE.

RAB fixtures must be wired in accordance with the National Electrical Code and all applicable local codes. Proper grounding is required for safety. THIS PRODUCT MUST BE INSTALLED IN ACCORDANCE WITH THE APPLICABLE INSTALLATION CODE BY A PERSON FAMILIAR WITH THE CONSTRUCTION AND OPERATION OF THE PRODUCT AND THE HAZARDS INVOLVED.

#### WARNINGS:

- Risk of electrical shock. Disconnect power at fuse or circuit breaker before installing or servicing.
- To prevent early lamp failure, lamp should only be installed in operating environments ranging between  $-30^{\circ}\text{C}$  and  $+40^{\circ}\text{C}$  ( $-22^{\circ}\text{F}$  and  $+104^{\circ}\text{F}$ ).
- No user serviceable parts inside. To avoid electrical shock do not disassemble product.
- Risk of fire or electric shock, LED Retrofit Kit installation requires knowledge of luminaires electrical systems. If not qualified, do not attempt installation. Contact a qualified electrician.
- Risk of fire or electric shock, Install this kit only in luminaires that have the construction features and min dimensions shown in the Figure 10 and where the input rating of the retrofit kit does not exceed the input rating of the luminaire.
- Do not make or alter any open holes in an enclosure of wiring or electrical components during kit installation
- To prevent wiring damage or abrasion, do not expose wiring to edges of sheet metal or other sharp objects.
- Installers should not disconnect existing wires from lampholder terminals to make new connections at lampholder terminals. Instead installers should cut existing lampholder leads away from the lampholder and make new electrical connections to lampholder lead wires by employing applicable connectors.
- This retrofit kit is accepted as a component of a luminaire where the suitability of the combination shall be determined by authorities having jurisdiction. Product must be installed by a qualified electrician in accordance with the applicable and appropriate electrical codes. The installation guide does not supersede local national regulations for electrical installations.
- This device is not intended for use with emergency exits.
- Caution - risk of fire. Consult a qualified electrician to ensure correct branch circuit conductor.
- Min.  $90^{\circ}\text{C}$  supply conductors.
- Installers should examine all parts that are not intended to be replaced by the retrofit kit for damage and replace any damaged parts prior to installation of the retrofit kit.

### WHAT'S IN THE BOX

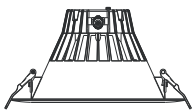

Downlight (1)



MC connector (1)



Wire Nuts (5)



Lumi Sticker (1)



Template (1)

### MIN. LUMINAIRE DIMENSION

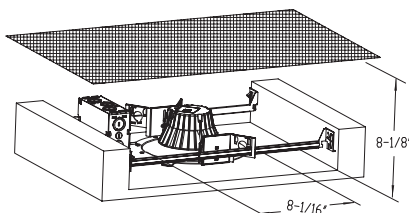

### TOOLS NEEDED

This LED Recessed Kit requires very few tools for installation. A screwdriver and a pair of wirecutters will help to install the downlight to a JBox or housing.

### OPTIONAL ACCESSORIES

#### Goof Ring

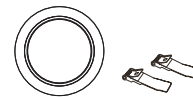

DL8-10GOOF/R/P  
For use with 10" ceiling hole applications  
DL8-12GOOF/R/P  
For use with 12" ceiling hole applications

#### Plate

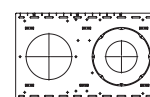

DLPLATE/T  
New construction or remodel plate for T-grid ceilings



DLJBOX/P/E2  
For use with emergency battery back-up

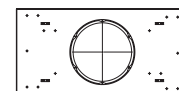

DLPLATE/SJ  
New construction plate for Stud/Joist

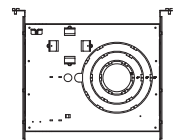

DLPLATE/C3468R/NB  
Mounting plate with nailer bar

# INSTRUCTIONS

## 8" Recessed Commercial Downlight FA



RAB Lighting is committed to creating high-quality, affordable, well-designed and energy-efficient LED lighting and controls that make it easy for electricians to install and end users to save energy. We'd love to hear your comments. Please call the Marketing Department at 888-RAB-1000 or email: [marketing@rablighting.com](mailto:marketing@rablighting.com)

### INSTALLATION WITH EXISTING FRAME

1. Shut power OFF to the fixture.
2. Remove CFL, Incandescent or HID lamp. (Fig.1)

Fig: 1

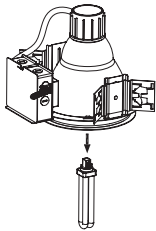

3. Remove reflector from rough-in (mounting frame). (Fig.2)

Fig: 2

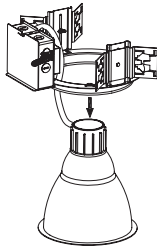

4. Remove socket assembly from reflector. (Fig.3)

Fig: 3

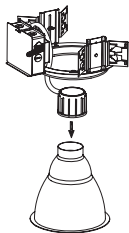

5. Remove J-Box metal plate with existing lamp ballast. Do not dispose. Disconnect all wires from the ballast. (Fig.4)

Fig: 4

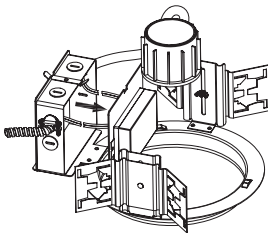

6. Remove the existing lamp metal conduit (MC) cable from the J-Box. (Fig.5)

Fig: 5

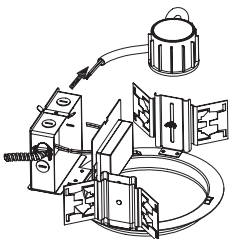

### INSTALLATION WITH EXISTING FRAME (cont'd)

7. Select desired CCT. (Fig.6)

Fig: 6

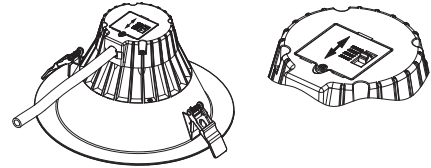

8. Fasten the LED retrofit kit MC cable to the J-Box with MC connector. (Fig.7)

Fig: 7

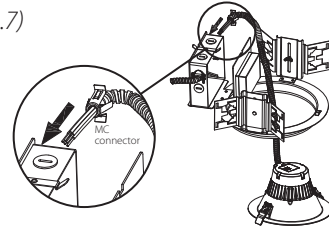

9. Wire nut the ground (green) wire in the junction box. Wire nut the black input wire with the black wire from the MC cable and wire nut the white input wire with the white wire from the MC cable. Wire nut the purple input wire with the purple wire from the MC cable and wire nut the grey input wire with the grey wire from the MC cable. If the purple and grey wires are not in use, cap these with wire nuts. (Fig.8)

Fig: 8

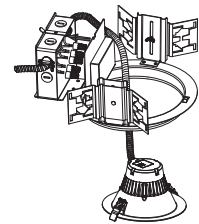

10. Put back J-Box metal plate (with lamp ballast still attached to it). (Fig.9)

Fig: 9

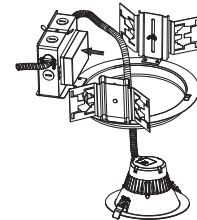

11. Install the retrofit kit in the rough-in by lifting upward both retention tabs. Push the kit until it sits flush against the ceiling. (Fig.10)

Fig: 10

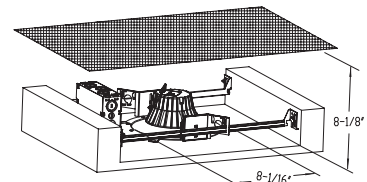

12. Turn power ON and start saving \$\$.

# INSTRUCTIONS

## 8" Recessed Commercial Downlight FA



RAB Lighting is committed to creating high-quality, affordable, well-designed and energy-efficient LED lighting and controls that make it easy for electricians to install and end users to save energy. We'd love to hear your comments. Please call the Marketing Department at 888-RAB-1000 or email: [marketing@rablighting.com](mailto:marketing@rablighting.com)

### INSTALLATION WITHOUT EXISTING FRAME

1. Use template inside box to cut hole in ceiling. (Fig.11)

Fig: 11

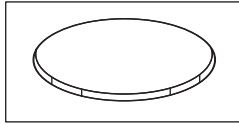

2. Select desired CCT. (Fig.12)

Fig: 12

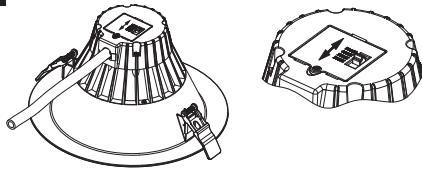

3. Shut power OFF to the fixture. Fasten the LED kit MC cable to a junction box with MC connector. Wire nut the ground (green) wire in the junction box. Wire nut the black input wire with the black wire from the MC cable and wire nut the white input wire with the white wire from the MC cable. Wire nut the purple input wire with the purple wire from the MC cable and wire nut the grey input wire with the grey wire from the MC cable. If the purple and grey wires are not in use, cap these with wire nuts. (Fig.13)

Fig: 13

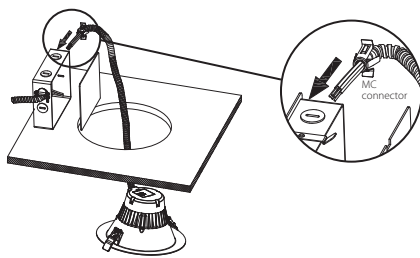

4. Install junction box cover plate. (Fig.14)

Fig: 14

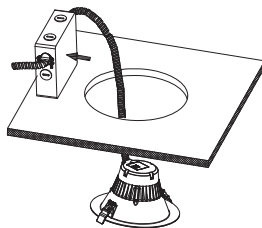

### INSTALLATION

### WITHOUT EXISTING FRAME (cont'd)

5. Install the LED kit by lifting both retention tabs upward. (Fig.15)

Fig: 15

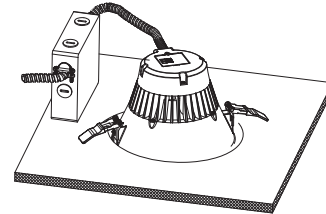

6. Push the kit until it sits flush against the ceiling. (Fig.16)

Fig: 16

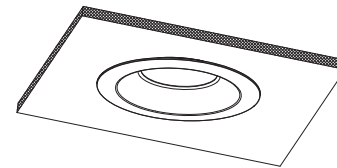

### DIMENSIONAL DRAWINGS

#### C8R229FAUNVW

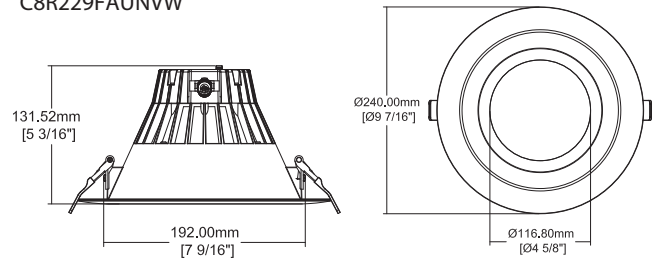

#### C8R339FAUNVW

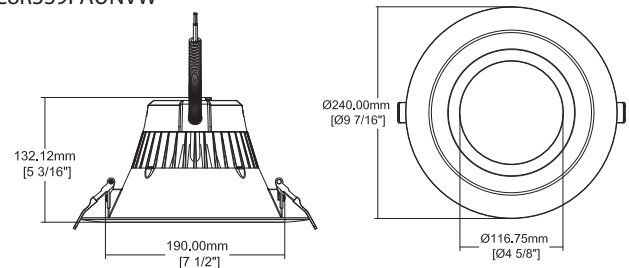

#### C8R559FAUNVW

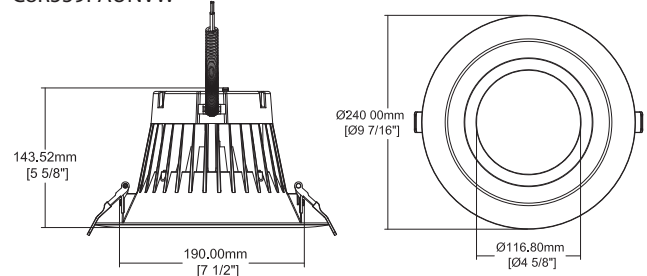

# INSTRUCTIONS

## 8" Recessed Commercial Downlight FA



RAB Lighting is committed to creating high-quality, affordable, well-designed and energy-efficient LED lighting and controls that make it easy for electricians to install and end users to save energy. We'd love to hear your comments. Please call the Marketing Department at 888-RAB-1000 or email: [marketing@rablighting.com](mailto:marketing@rablighting.com)

### OPTIONAL ACCESSORY INSTALLATION

1. Remove the access cover from the top of the LED retrofit kit. Remove the red switch. (Fig.17)

Fig: 17

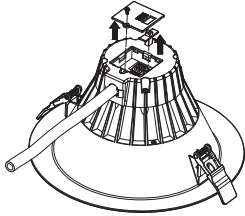

2. With a small flat screw driver or other tool, push on the connector buttons to release the jumper wires. Pull the wires out and discard. (Fig.18)

Fig: 18

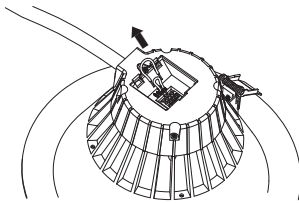

3. Snap the junction box to the top of the LED retrofit kit. Firmly push on top until you hear the 3 snaps fully engage. The junction box should feel firmly attached. If not, push again to make sure all snaps have engaged. (Fig.19)

Fig: 19

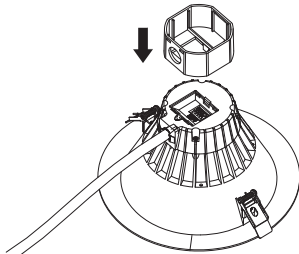

4. Adjust dial settings on the Emergency Battery Backup System (EMBB) for desired output current. Reference EMBB List table. (Fig.20)

Fig: 20

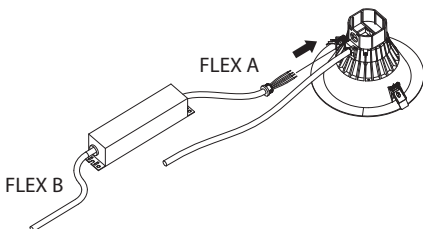

6. Take the Emergency Battery Backup System (EMBB) and insert the flex B MC cable into the hole of the LED retrofit junction box. Push the snap-in connector firmly in place to create a strong attachment. If the insertion of the snap-in MC connector shows strong resistance, push down on the snap-in tabs in with pliers to allow for an easier insertion.

### OPTIONAL ACCESSORY INSTALLATION(cont'd)

6. Inside the LED retrofit junction box, create the connections, as indicated, by simply pushing each wire into its corresponding connector. Close the junction box with the provided cover. (Fig.21)

Fig: 21

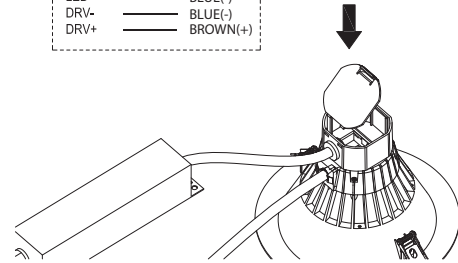
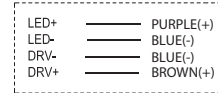

### 7. EMBB INSTALLATION WITH EXISTING FRAME

- a. A test switch is provided with the EMBB. If required for your installation, install it with the appropriate hardware. A suggested installation is shown here. The conduit and box for the test switch are not provided. (Fig.22)

Fig: 22

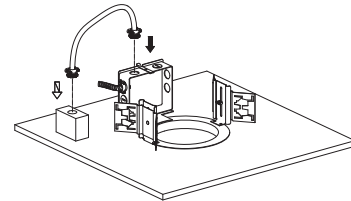

- b. Fasten the LED retrofit kit MC cable to the J-Box. Snap-in the Flex A MC cable from the EMBB unit into the J-box. (Fig.23)

Fig: 23

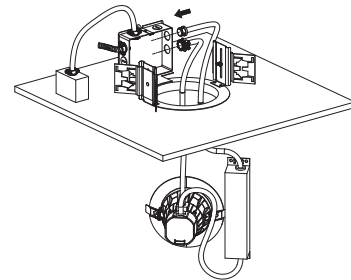

- c. In the J-box, use wire nuts to do the wire connections as illustrated in the diagram below. If the purple (DIM+) and grey (DIM-) wires from the downlight are not in use, cap these with wire nuts. If the test switch is not in use, cap the purple (Test +) and brown (Test -) wire from the EMBB with wire nuts. Make sure EMBB is grounded. (Fig.24)

**Note:** These instructions do not cover all details or variations in equipment nor do they provide for every possible situation during installation, operation or maintenance.

# INSTRUCTIONS

## 8" Recessed Commercial Downlight FA



RAB Lighting is committed to creating high-quality, affordable, well-designed and energy-efficient LED lighting and controls that make it easy for electricians to install and end users to save energy. We'd love to hear your comments. Please call the Marketing Department at 888-RAB-1000 or email: [marketing@rablighting.com](mailto:marketing@rablighting.com)

### OPTIONAL ACCESSORY INSTALLATION (cont'd)

### OPTIONAL ACCESSORY INSTALLATION (cont'd)

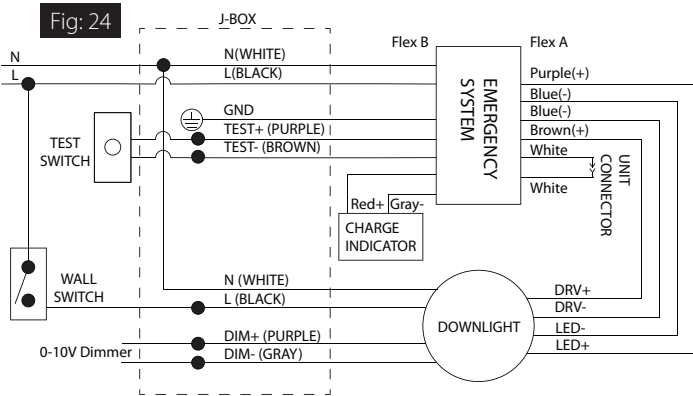

- d. Put back J-Box metal plate (with lamp ballast still attached to it). (Fig.25)

Fig: 25

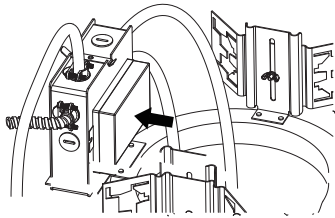

- e. Make sure the EMBB is mechanically attached. Install the retrofit kit in the rough-in by lifting upward both retention tabs. Push the kit until it sits flush against the ceiling. (Fig.26)

Fig: 26

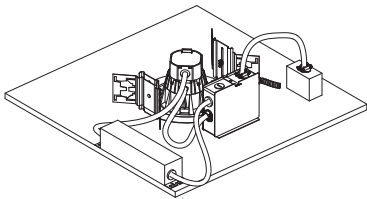

### 8. EMBB INSTALLATION WITHOUT EXISTING FRAME

- a. A test switch is provided with the EMBB. If required for your installation, install it with the appropriate hardware. A suggested installation is shown here. The conduit and box for the test switch are not provided. (Fig.27)

Fig: 27

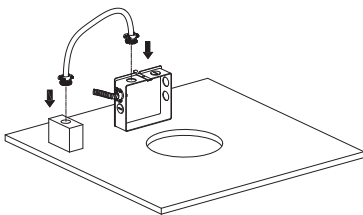

- b. Fasten the LED retrofit kit MC cable to the J-Box. Snap-in the Flex A MC cable from the EMBB unit into the J-box. (Fig.28)

Fig: 28

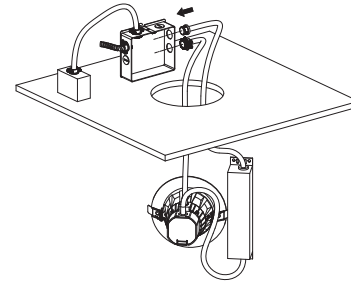

- c. In the J-box, use wire nuts to do the wire connections as illustrated in the diagram below. If the purple (DIM+) and grey (DIM-) wires from the downlight are not in use, cap these with wire nuts. If the test switch is not in use, cap the purple (Test +) and brown (Test -) wire from the EMBB with wire nuts. Make sure EMBB is grounded. (Fig.29)

Fig: 29

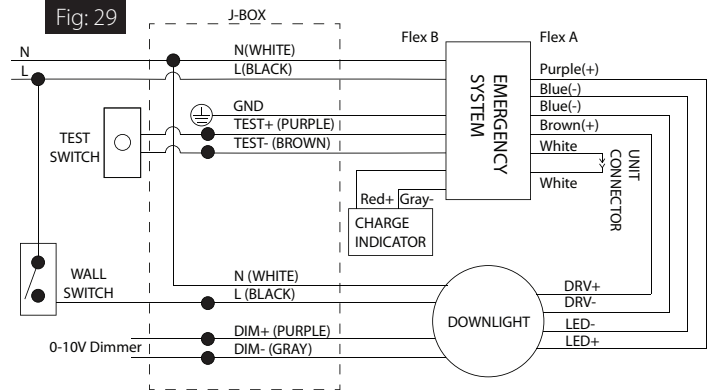

- d. Put back J-Box metal plate.

- e. Make sure the EMBB is mechanically attached. Install the retrofit kit in the rough-in by lifting upward both retention tabs. Push the kit until it sits flush against the ceiling. (Fig.30)

Fig: 30

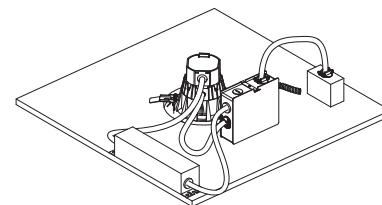

- f. Turn power ON and start saving \$\$.



### Easy Answers

[rablighting.com](http://rablighting.com)  
Visit our website for product info

Tech Help Line  
Call our experts: 888 722-1000

e-mail  
Answered promptly - [sales@rablighting.com](mailto:sales@rablighting.com)

Free Lighting Layouts  
Answered online or by request