

# INSTRUCTIONS

## BULKHEAD™ ROUND FIELD ADJUSTABLE INSTALLATION

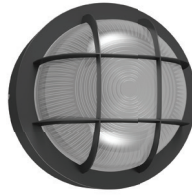

RAB Lighting is committed to creating high-quality, affordable, well-designed and energy-efficient LED lighting and controls that make it easy for electricians to install and end users to save energy. We'd love to hear your comments. Please call the Marketing Department at 888-RAB-1000 or email: [marketing@rablighting.com](mailto:marketing@rablighting.com)



### IMPORTANT

#### READ CAREFULLY BEFORE INSTALLING FIXTURE. RETAIN THESE INSTRUCTIONS FOR FUTURE REFERENCE.

RAB fixtures must be wired in accordance with the National Electrical Code and all applicable local codes. Proper grounding is required for safety. THIS PRODUCT MUST BE INSTALLED IN ACCORDANCE WITH THE APPLICABLE INSTALLATION CODE BY A PERSON FAMILIAR WITH THE CONSTRUCTION AND OPERATION OF THE PRODUCT AND THE HAZARDS INVOLVED.

**WARNING: Make certain power is OFF before installing or maintaining fixture. No user serviceable parts inside.**

**CAUTION: For proper weatherproof function all gaskets must be seated properly and all screws inserted and tightened firmly. Apply weatherproof silicone sealant around the edge of the ceiling or wall mounting box and/or junction box. This is especially important with an uneven surface. Silicone all plugs and unused conduit entries.**

**Suitable for Wet locations. Suitable for operation in ambient not exceeding 45° C.**

**Do not switch under load.**

### FIXTURE MOUNTING

1. Use an Allen Wrench to remove (2) Set Screws and the Mounting Plate from fixture as shown in Fig. 1.
2. Install Mounting Plate with (2) Screws to Junction Box (by others) as shown in Fig. 2.
3. Secure fixture Tether Cable to the Mounting Plate (Fig. 3) for hands free wiring.
4. Connect the fixture wires to the supply wires making sure to use correct UL rated wire connectors as required by NEC to complete electrical splices and connections (Fig. 6).
5. *Make any field adjustment selection at this time (see Field Adjustment section (Fig. 5)).*
6. Re-attach fixture to Mounting Plate using the (2) Set Screws (Fig. 4)
7. Apply weatherproof silicone sealant around the edge of the ceiling or wall mounting box and/or junction box. This is especially important with an uneven surface.

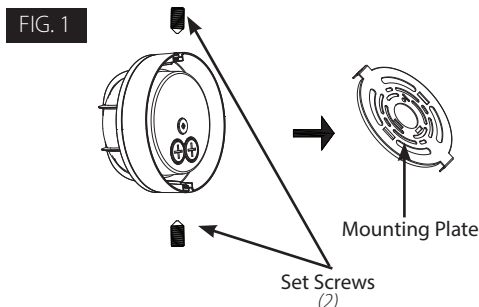

FIG. 2

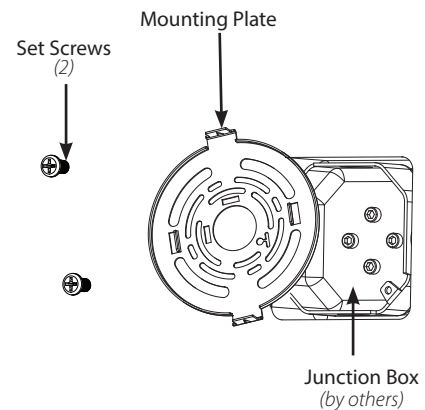

FIG. 3

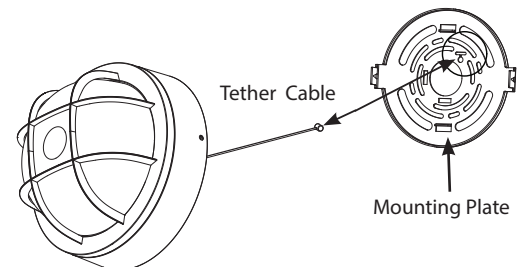
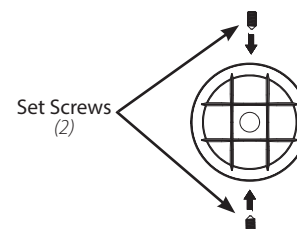

FIG. 4



# INSTRUCTIONS

## BULKHEAD™ ROUND FIELD ADJUSTABLE INSTALLATION



RAB Lighting is committed to creating high-quality, affordable, well-designed and energy-efficient LED lighting and controls that make it easy for electricians to install and end users to save energy. We'd love to hear your comments. Please call the Marketing Department at 888-RAB-1000 or email: [marketing@rablighting.com](mailto:marketing@rablighting.com)

### FIELD ADJUSTMENT

#### Photocell Operation:

This product is equipped with a photocell. Should you wish to disable this feature, slide the switch to the "Off" position. **Allow 15 seconds for light to turn on/off when photocell is in "ON" position.**

#### Color Temperature (CCT) Selection:

This product is equipped with 3000, 4000 and 5000K CCT color temperature selection. For maximum light output use the 5000K Color Temperature.

#### Power (Wattage) Selection:

This product is equipped with Power (W) output selection. BULKH15 (15/12/9W)

Follow instructions below to change Photocell ON/OFF function, Color Temperature (CCT) and/or Power (W) from factory settings.

#### Factory Settings:

15W, 5000K CCT, Photocell/ON

1. Locate the selector switches on back of housing as shown in Fig. 5 and open the cover to make field adjustment.
2. Select **Color Temperature (CCT)**, **Power (W)** and or **Photocell** On/Off function by sliding the respective switch to the desired value (Fig. 5).
3. Replace field adjustment covers.

FIG. 5

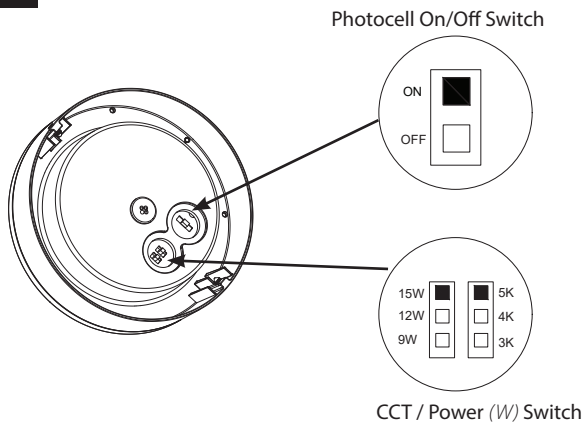

### 0-10V DIMMABLE WIRING

Universal voltage driver permits operation at 120V through 277V, 50 or 60 Hz. For 0-10V dimming, follow the wiring directions as shown in Fig. 6.

1. Connect the black fixture lead to the **LINE** supply lead.
2. Connect the white fixture lead to the **COMMON** supply lead.
3. Connect the Green wire from the fixture to supply Ground. **DO NOT** connect Ground of the dimming fixture to the output.
4. Connect the purple fixture lead to the (V+) **DIM** lead.
5. Connect the pink fixture lead to the (V-) **DIM** lead.

FIG. 6

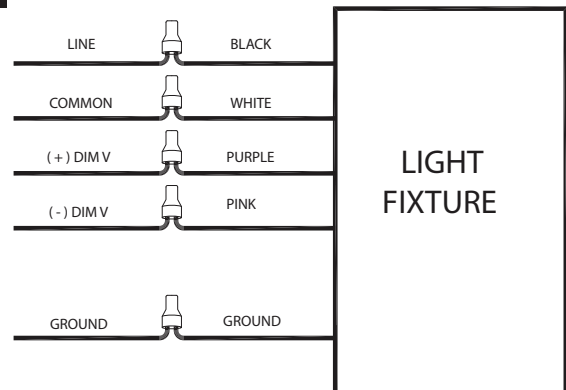

### CLEANING & MAINTENANCE

**CAUTION:** Be sure fixture temperature is cool enough to touch. Do not clean or maintain while fixture is energized.

1. Clean Lens and Fixture with non-abrasive cleaning solution.
2. Do not open the fixture to clean the LED. Do not touch the LED.

### TROUBLESHOOTING

1. Check that the line voltage at the fixture is correct. Refer to wiring directions.
2. Is the fixture grounded properly?

**Note:** These instructions do not cover all details or variations in equipment nor do they provide for every possible situation during installation, operation or maintenance.



© 2025 RAB LIGHTING Inc.

BULKH15 - IN - 1124  
P-101432

#### Easy Answers

[rablighting.com](http://rablighting.com)  
Visit our website for product info

Tech Help Line  
Call our experts: 888 722-1000

e-mail  
Answered promptly - [sales@rablighting.com](mailto:sales@rablighting.com)

Free Lighting Layouts  
Answered online or by request

**RAB WARRANTY:** RAB's warranty is subject to all terms and conditions found at [rablighting.com/warranty](http://rablighting.com/warranty).