



## Technical Specifications (continued)

### Surge Protection:

2.5kV

For areas prone to surges, upgrade to 10kV surge protection available

### Other

#### Replacement:

Replaces 8-lamp T5HO or 575W MH

#### 5 Yr Limited Warranty:

The RAB 5-year, limited warranty covers light output, driver performance and paint finish. RAB's warranty is subject to all terms and conditions found at [rablighting.com/warranty](http://rablighting.com/warranty).

#### Buy American Act Compliance:

RAB values USA manufacturing! Upon request, RAB may be able to manufacture this product to be compliant with the Buy American Act (BAA). Please contact customer service to request a quote for the product to be made BAA compliant.

## Dimensions

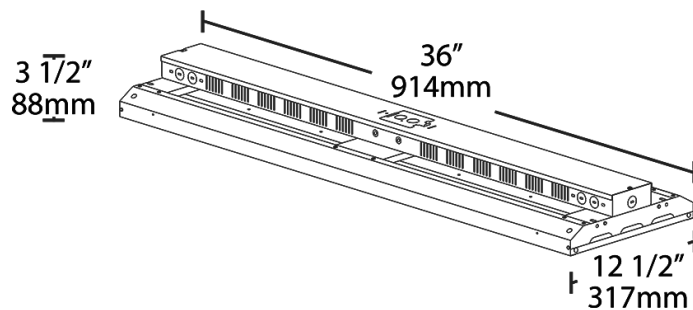

## Features

- High efficiency. Low price.
- Ideal for industrial warehouse spaces
- 100,000 hour LED lifespan
- 5-Year, limited warranty

Ordering Matrix

Family	Length		Wattage	Color Temp	Voltage	Control Options	Emergency Options	Other Options
ARBAY	3	-	275	N		/LC		
	3 = 3 ft		215 = 215W 275 = 275W	Blank = 5000K Cool N = 4000K Neutral	Blank = 120-277V, 0-10V Dimming /480 = 480V, 0-10V Dimming	Blank = No Options /PIR = 120-277V, Passive Infrared Occupancy Sensor /LC = Lightcloud® Control /LCS = 120-277V, Lightcloud® Motion Sensor	Blank = No Options /E2 = 120-277V, Battery <sup>1</sup>	Blank = No Options /SP10 = 10kV Surge Protection /8C = 8' Cord only <sup>2</sup> /8CP = 8' Cord, Straight Blade Plug 120V, NEMA 5-15P <sup>3</sup> /8CP2 = 8' Cord, Straight Blade Plug 277V, NEMA 7-15P <sup>3</sup> /8CPT = 8' Cord, Twistlock Plug 120V, NEMA L5-15P <sup>3</sup> /8CPT2 = 8' Cord, Twistlock Plug 277V, NEMA L7-15P <sup>3</sup> /8CPT4 = 8' Cord, Twistlock Plug 480V, NEMA L8-20P <sup>3</sup>

<sup>1</sup> For battery backup models with cord and plug dimming is not possible  
<sup>2</sup> For cord only (8C) models, a 5 conductor cable will be used to make dimming possible  
<sup>3</sup> For cord and plug (8CP, 8CP2, 8CPT, 8CPT2, 8CPT4) models 0-10V dimming is not possible