

Project:	Type:
Prepared By:	Date:

Driver Info		LED Info	
Type	Constant Current	Watts	275W
120V	N/A	Color Temp	5000K (Cool)
208V	N/A	Color Accuracy	83 CRI
240V	N/A	L70 Lifespan	100,000 Hours
277V	N/A	Lumens	38,391 lm
Input Watts	258.7W	Efficacy	148.4

Technical Specifications

Performance

Lifespan:

100,000-Hour LED lifespan based on IES LM-80 results and TM-21 calculations

LED Characteristics

LEDs:

Multi-chip, high-output, long-life LEDs

Color Uniformity:

RAB's range of Correlated Color Temperature follows the guidelines of the American National Standard for Specifications for the Chromaticity of Solid State Lighting (SSL) Products, ANSI C78.377-2017.

Construction

Operating Temperature:

-20°C (-4°F) to 50°C (122°F)

Housing:

22 gauge die formed with white powder coat finish. Y Hooks included for easy chain or cable mounting.

Reflector:

White painted, reflective, die formed painted steel

Lens:

Polycarbonate lens

Mounting:

V hooks and optional pendant mounting. AEROBAY® comes with two 42" chains.

Finish:

Our environmentally friendly polyester powder coatings are formulated for high-durability and long-lasting color

Green Technology:

Mercury and UV free. RoHS-compliant components.

Lightcloud

Lightcloud Controller Installed:

Integrated/embedded networked lighting control, luminaire-level lighting control. Fixture, Zone, and plug-load control from one powerful device. LLLC - capable of switching, 0-10V dimming, power/energy monitoring. Can also be used to extend the range of the Lightcloud mesh network communication protocols. Offers the capability to set the maximum light output to a less-than-maximum state of an individual luminaire at the time of installation or commissioning. The High-End trim functionality is field reconfigurable via the Lightcloud mesh network communication protocols. The Lightcloud controller can be attached to the fixture, junction box, or electrical panel.
DLC system - N1XMLOEATBA
[Learn more about Lightcloud.](#)

Electrical

Driver:

Class 2, Constant Current, 50/60 Hz, 480V: 0.56A

THD:

8.31% at 480V

Power Factor:

98.3% at 480V

Surge Protection:

6kV

Other

Replacement:

Replaces 8-lamp T5HO or 575W MH

5 Yr Limited Warranty:

The RAB 5-year, limited warranty covers light output, driver performance and paint finish. RAB's warranty is subject to all terms and conditions found at rablighting.com/warranty.

Buy American Act Compliance:

RAB values USA manufacturing! Upon request, RAB may be able to manufacture this product to be compliant with the Buy American Act (BAA). Please contact customer service to request a quote for the product to be made BAA compliant.

Technical Specifications (continued)

Compliance

DLC Listed:

This product is listed by Design Lights Consortium (DLC) as an ultra-efficient premium product that qualifies for the highest tier of rebates from DLC Member Utilities. Designed to meet DLC 5.1 requirements.

DLC Product Code: PKENYBON

Dimensions

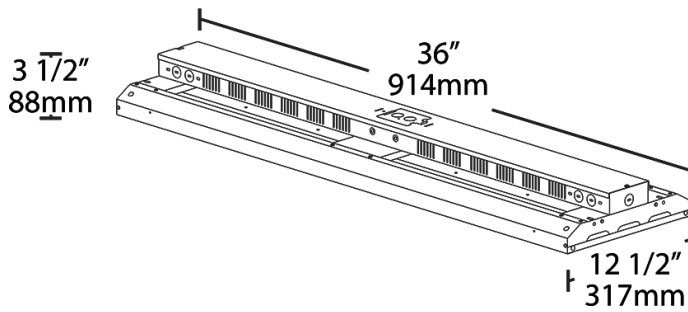

Features

- High efficiency. Low price.
- Ideal for industrial warehouse spaces
- 100,000 hour LED lifespan
- 5-Year, limited warranty

Ordering Matrix

Family	Length	Wattage	Color Temp	Voltage	Control Options	Emergency Options	Other Options
ARBAY	3 3 = 3 ft	- 275 215 = 215W 275 = 275W	Blank = 5000K Cool N = 4000K Neutral	/480 Blank = 120-277V, 0-10V Dimming /480 = 480V, 0-10V Dimming	/LC Blank = No Options /PIR = 120-277V, Passive Infrared Occupancy Sensor /LC = Lightcloud® Control /LCS = 120-277V, Lightcloud® Motion Sensor	Blank = No Options /E2 = 120-277V, Battery ¹	Blank = No Options /SP10 = 10kV Surge Protection /8C = 8' Cord only ² /8CP = 8' Cord, Straight Blade Plug 120V, NEMA 5-15P ³ /8CP2 = 8' Cord, Straight Blade Plug 277V, NEMA 7-15P ³ /8CPT = 8' Cord, Twistlock Plug 120V, NEMA L5-15P ³ /8CPT2 = 8' Cord, Twistlock Plug 277V, NEMA L7-15P ³ /8CPT4 = 8' Cord, Twistlock Plug 480V, NEMA L8-20P ³

¹ For battery backup models with cord and plug dimming is not possible

² For cord only (8C) models, a 5 conductor cable will be used to make dimming possible

³ For cord and plug (8CP, 8CP2, 8CPT, 8CPT2, 8CPT4) models 0-10V dimming is not possible