

INSTRUCTIONS

ALLURE VANITY & WALL SCONCE INSTALLATION

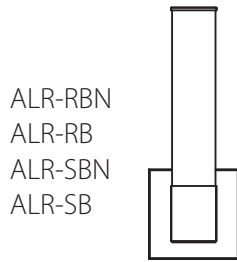

RAB Lighting is committed to creating high-quality, affordable, well-designed and energy-efficient LED lighting and controls that make it easy for electricians to install and end users to save energy. We'd love to hear your comments. Please call the Marketing Department at 888-RAB-1000 or email: marketing@rablighting.com



ALR-RBN
ALR-RB
ALR-SBN
ALR-SB

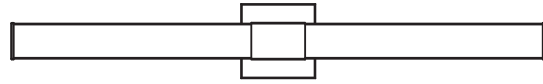

ALR-24RBN	ALR-36RBN	ALR-48RBN
ALR-24RB	ALR-36RB	ALR-48RB
ALR-24SBN	ALR-36SBN	ALR-48SBN
ALR-24SB	ALR-36SB	ALR-48SB

IMPORTANT

READ CAREFULLY BEFORE INSTALLING FIXTURE. RETAIN THESE INSTRUCTIONS FOR FUTURE REFERENCE.

RAB fixtures must be wired in accordance with the National Electrical Code and all applicable local codes. Proper grounding is required for safety. THIS PRODUCT MUST BE INSTALLED IN ACCORDANCE WITH THE APPLICABLE INSTALLATION CODE BY A PERSON FAMILIAR WITH THE CONSTRUCTION AND OPERATION OF THE PRODUCT AND THE HAZARDS INVOLVED.

WARNING:

- Make certain power is OFF before installing or maintaining fixture. No user serviceable parts inside.
- Suitable for damp location.
- Suitable for operation in ambient not exceeding 40°C.

WHAT'S IN THE BOX

ALR-RBN
ALR-RB
ALR-SBN
ALR-SB

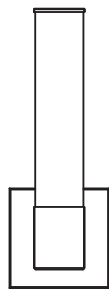

Fixture



Mounting plate



(4) M4 x10 mm
Screws



(3) P3 Wire Nuts



(2) 8#-32x1 Screws

ALR-24RBN
ALR-24RB
ALR-24SBN
ALR-24SB
ALR-36RBN
ALR-36RB
ALR-36SBN
ALR-36SB
ALR-48RBN
ALR-48RB
ALR-48SBN
ALR-48SB

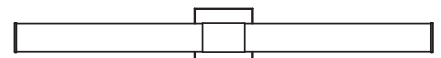

Fixture



Mounting plate



(4) M4 x10 mm
Screws



(3) P3 Wire Nuts



(2) 8#-32x1 Screws

INSTRUCTIONS

ALLURE VANITY & WALL SCONCE INSTALLATION



RAB Lighting is committed to creating high-quality, affordable, well-designed and energy-efficient LED lighting and controls that make it easy for electricians to install and end users to save energy. We'd love to hear your comments. Please call the Marketing Department at 888-RAB-1000 or email: marketing@rablighting.com

INSTALLATION

INSTALLATION & ASSEMBLY

1. An octagonal junction box must be installed at each desired location, before installing the luminaire. The box must have a depth of at least 1/2".
2. Twist counter clockwise to loosen **canopy screws** (Fig. 1).
3. Remove **mounting bracket** from luminaire. Do not remove any other parts (Fig. 1).
4. Adjust **mounting bracket** so the arms are facing away from junction box. Pull power supply wires from junction box through the center opening of **mounting bracket** (Fig. 2).
5. Attach **mounting bracket** to junction box, make sure **mounting bracket** is flushed and leveled before tightening with **mounting screws** (Fig. 2).
6. Make electrical wiring connections between luminaire and power supply (see *ELECTRICAL WIRING* below).
7. Position luminaire over junction box, pass canopy over arms from mounting bracket.
8. Secure canopy and mounting bracket with canopy screws.

ELECTRICAL WIRING

1. Strip 3/8" of bare power supply wires from junction box.
2. Follow the wires connection guide to connect wires from luminaire to power supply wires from junction box, using the wire nuts.
3. Connect neutral wire (white) from junction box to neutral wire (white) from luminaire.
4. Connect hot wire (black) from junction box to live wires (black) from luminaire.
5. Connect green ground wire from luminaire to bare copper ground wire from junction box, using a wire nut.
6. Once the connections are done, push wires back inside junction box.

Your installation is now complete. Return power and test the fixture.

IMPORTANT: FIXTURE SHOULD BE INSTALLED BY A QUALIFIED ELECTRICIAN TO ENSURE PROPER WIRING AND INSTALLATION.

Fig: 1

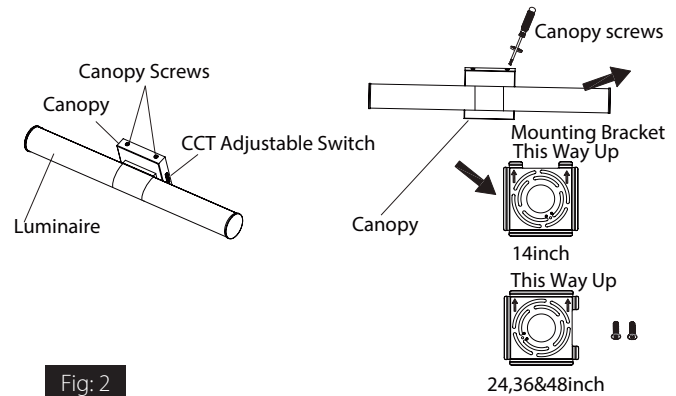

Fig: 2

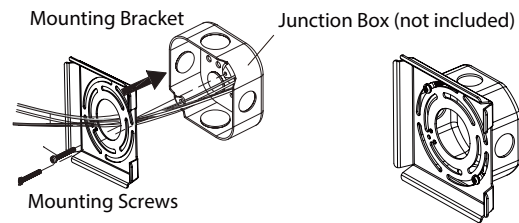
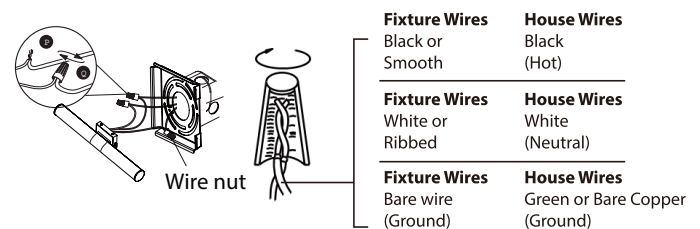

Fig: 3



INSTRUCTIONS

ALLURE VANITY & WALL SCONCE INSTALLATION



RAB Lighting is committed to creating high-quality, affordable, well-designed and energy-efficient LED lighting and controls that make it easy for electricians to install and end users to save energy. We'd love to hear your comments. Please call the Marketing Department at 888-RAB-1000 or email: marketing@rablighting.com

CLEANING & MAINTENANCE

CAUTION: Be sure fixture temperature is cool enough to touch.

Do not clean or maintain while fixture is energized.

1. Do not open fixture to clean the LED. Do not touch the LED.
2. Do not touch reflector.
3. Do not clean any fixture surface with wood-base cleaning material such as paper towels or tissues.

TROUBLESHOOTING

1. Check that the line voltage at the fixture is correct. Refer to wiring directions.
2. Is the fixture grounded properly?

DIMMENSION

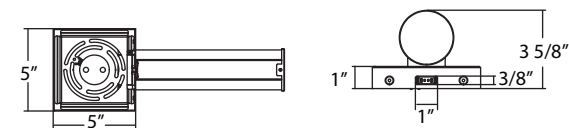
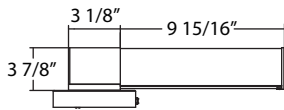
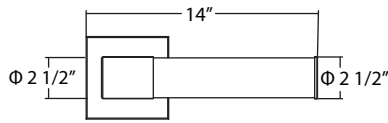

ALR-RBN
ALR-RB

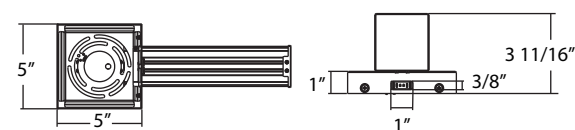
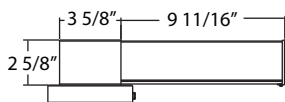
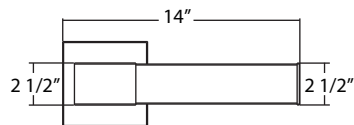

ALR-SBN
ALR-SB

DIMMENSION (cont'd)

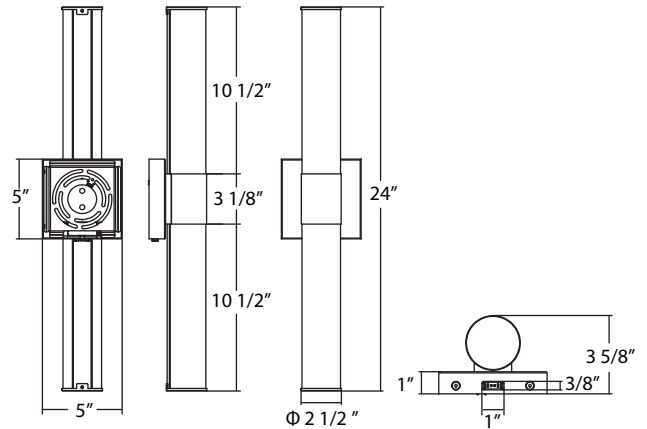

ALR-24RBN
ALR-24RB

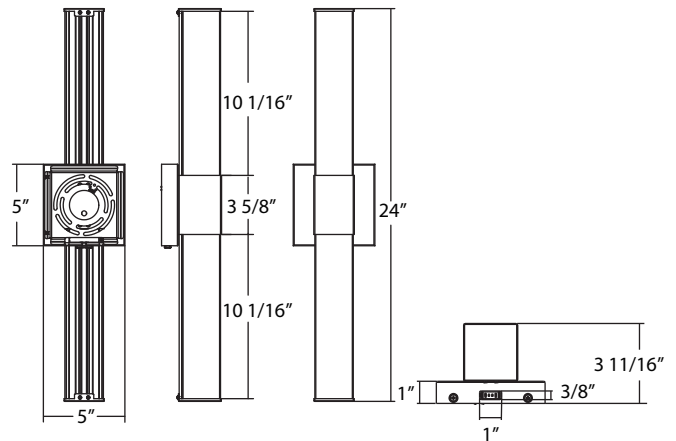

ALR-24SBN
ALR-24SB

INSTRUCTIONS

ALLURE VANITY & WALL SCONCE INSTALLATION



RAB Lighting is committed to creating high-quality, affordable, well-designed and energy-efficient LED lighting and controls that make it easy for electricians to install and end users to save energy. We'd love to hear your comments. Please call the Marketing Department at 888-RAB-1000 or email: marketing@rablighting.com

DIMMENSION (cont'd)

