

High output LED pole top area light with IES type V square distribution. Wide and uniform 360 degree pattern ideal for large outdoor areas such as parking lots, corporate parks, and retail settings.

Color: White

Weight: 33.1 lbs

Project:	Type:
Prepared By:	Date:

Driver Info		LED Info	
Type	Constant Current	Watts	78W
120V	0.56A	Color Temp	3000K (Warm)
208V	0.34A	Color Accuracy	73 CRI
240V	0.33A	L70 Lifespan	100,000 Hours
277V	0.26A	Lumens	9,437 lm
Input Watts	65.8W	Efficacy	143.4 lm/W

Technical Specifications

Compliance

UL Listed:

Suitable for wet locations

IESNA LM-79 & lm-80 Testing:

RAB LED luminaires and LED components have been tested by an independent laboratory in accordance with IESNA lm-79 and lm-80

DLC Listed:

This product is listed by Design Lights Consortium (DLC) as an ultra-efficient premium product that qualifies for the highest tier of rebates from DLC Member Utilities. Designed to meet DLC 5.1 requirements.

DLC Product Code: P2ZJKF8X

LED Characteristics

LEDs:

Long-life, high-efficacy, surface-mount LEDs

Color Consistency:

7-step MacAdam Ellipse binning to achieve consistent fixture-to-fixture color

Color Stability:

LED color temperature is warranted to shift no more than 200K in color temperature over a 5-year period

Color Uniformity:

RAB's range of Correlated Color Temperature follows the guidelines of the American National Standard for Specifications for the Chromaticity of Solid State Lighting (SSL) Products, ANSI C78.377-2017.

Performance

Lifespan:

100,000-Hour LED lifespan based on IES LM-80 results and TM-21 calculations

Wattage Equivalency:

Equivalent to 250W Metal Halide

Optical

BUG Rating:

B3 U1 G2

Optics:

Square, Type V distribution

Construction

Cold Weather Starting:

The minimum starting temperature is -40°C (-40°F)

Maximum Ambient Temperature:

Suitable for use in up to 40°C (104°F)

Thermal Management:

Superior thermal management with external air-flow fins

Effective Projected Area:

EPA = 0.7

Lens:

Clear polycarbonate lens

Reflector:

Vacuum-metallized polycarbonate

Gaskets:

High-temperature silicone

Mounting:

Tenon for 2 3/8" or 3" OD post or pole-top adaptor

Finish:

Formulated for high durability and long-lasting color

Green Technology:

Mercury and UV free. RoHS-compliant components.

Electrical

Driver:

Constant Current, Class 2 with 4kV surge protection, 120-277VAC, 50/60 Hz, 120V: 0.56A, 208V: 0.34A, 240V: 0.33A, 277V: 0.26A

Technical Specifications (continued)

THD:

5.57% at 120V, 9.27% at 277V

Power Factor:

99.4% at 120V, 91.6% at 277V

ALED5S78 with Dimmable Drive:

Driver includes dimming control for 0-10V dimming systems. Requires separate 0-10V DC dimming circuit. Dims down to 10%.

Other

Patents:

The designs of the ALED5S are protected by patents pending in US, Canada, China, Taiwan and Mexico

Warranty:

RAB warrants that our LED products will be free from defects in materials and workmanship for a period of five (5) years from the date of delivery to the end user, including coverage of light output, color stability, driver performance and fixture finish. RAB's warranty is subject to all terms and conditions found at rablighting.com/warranty.

Buy American Act Compliance:

RAB values USA manufacturing! Upon request, RAB may be able to manufacture this product to be compliant with the Buy American Act (BAA). Please contact customer service to request a quote for the product to be made BAA compliant.

Dimensions

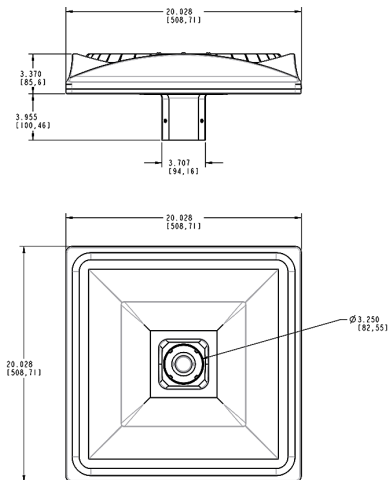

Features

Precision optics deliver uniform, optimal light distribution

Perfect for parking lots and pathways

100,000-Hour LED lifespan

Ordering Matrix

Family	Wattage	Color Temp	Finish	Driver Options	Sensor Options	Other Options
ALED5S	78	Y	W	/D10	/7PR	
	78 = 78W 150 = 150W	Blank = 5000K Cool N = 4000K Neutral Y = 3000K Warm	Blank = Bronze W = White	/D10 = 120-277V, 0-10V Dimming /480/D10 = 480V, 0-10V Dimming /BL = Bi-Level	Blank = No Option /PCT = 120-277V Twistlock Photocell /PCT4 = 480V Twistlock Photocell /WS2 = Motion Sensor/Photocell /LC = Lightcloud® Controller /5PR = 5 Pin Receptacle /7PR = 7-Pin Receptacle /7PR/WS2 = 7-Pin Receptacle w/ Motion Sensor	Blank = Standard USA = BAA Compliant