



High output LED pole top area light with IES type V square distribution. Wide and uniform 360 degree pattern ideal for large outdoor areas such as parking lots, corporate parks, and retail settings.

Color: Bronze

Weight: 33.1 lbs

<b>Project:</b>	<b>Type:</b>
<b>Prepared By:</b>	<b>Date:</b>

Driver Info		LED Info	
Type	Constant Current	Watts	150W
120V	1.76A	Color Temp	4000K (Neutral)
208V	0.73A	Color Accuracy	73 CRI
240V	0.63A	L70 Lifespan	100,000 Hours
277V	0.54A	Lumens	17,420 lm
Input Watts	140.5W	Efficacy	124 lm/W

## Technical Specifications

### Compliance

#### UL Listed:

Suitable for wet locations

#### IESNA LM-79 & lm-80 Testing:

RAB LED luminaires and LED components have been tested by an independent laboratory in accordance with IESNA lm-79 and lm-80

#### DLC Listed:

This product is listed by Design Lights Consortium (DLC) as an ultra-efficient premium product that qualifies for the highest tier of rebates from DLC Member Utilities. Designed to meet DLC 5.1 requirements.

DLC Product Code: P429686B

### LED Characteristics

#### LEDs:

Long-life, high-efficacy, surface-mount LEDs

#### Color Consistency:

7-step MacAdam Ellipse binning to achieve consistent fixture-to-fixture color

#### Color Stability:

LED color temperature is warranted to shift no more than 200K in color temperature over a 5-year period

#### Color Uniformity:

RAB's range of Correlated Color Temperature follows the guidelines of the American National Standard for Specifications for the Chromaticity of Solid State Lighting (SSL) Products, ANSI C78.377-2017.

### Performance

#### Lifespan:

100,000-Hour LED lifespan based on IES LM-80 results and TM-21 calculations

#### Wattage Equivalency:

Equivalent to 400W Metal Halide

### Optical

#### BUG Rating:

B4 U0 G3

#### Optics:

Square, Type V distribution

### Construction

#### Cold Weather Starting:

The minimum starting temperature is -40°C (-40°F)

#### Maximum Ambient Temperature:

Suitable for use in up to 40°C (104°F)

#### Thermal Management:

Superior thermal management with external air-flow fins

#### Effective Projected Area:

EPA = 0.7

#### Lens:

Clear polycarbonate lens

#### Reflector:

Vacuum-metallized polycarbonate

#### Gaskets:

High-temperature silicone

#### Mounting:

Tenon for 2 3/8" or 3" OD post or pole-top adaptor

#### Finish:

Formulated for high durability and long-lasting color

#### Green Technology:

Mercury and UV free. RoHS-compliant components.

### Electrical

#### Driver:

Constant Current, Class 2 with 4kV surge protection, 120-277VAC, 50/60 Hz, 120V: 1.76A, 208V: 0.73A, 240V: 0.63A, 277V: 0.54A

## Technical Specifications (continued)

### Dimming Driver:

Driver includes dimming control wiring for 0-10V dimming systems. Requires separate 0-10V DC dimming circuit. Dims down to 10%.

### THD:

5.96% at 120V, 9.63% at 277V

### Power Factor:

99.5% at 120V, 92.3% at 277V

### Other

#### Patents:

The designs of the ALED5S are protected by patents pending in US, Canada, China, Taiwan and Mexico

#### Warranty:

RAB warrants that our LED products will be free from defects in materials and workmanship for a period of five (5) years from the date of delivery to the end user, including coverage of light output, color stability, driver performance and fixture finish. RAB's warranty is subject to all terms and conditions found at [rablighting.com/warranty](http://rablighting.com/warranty).

#### Buy American Act Compliance:

RAB values USA manufacturing! Upon request, RAB may be able to manufacture this product to be compliant with the Buy American Act (BAA). Please contact customer service to request a quote for the product to be made BAA compliant.

## Dimensions

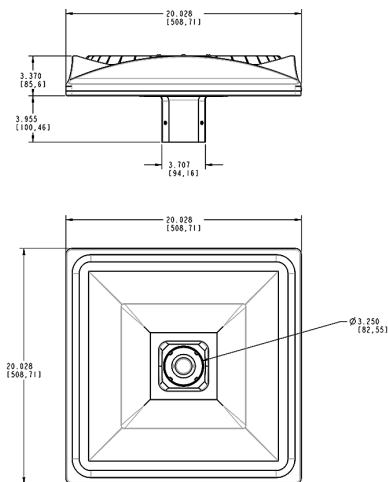

## Features

Precision optics deliver uniform, optimal light distribution

Perfect for parking lots and pathways

100,000-Hour LED lifespan

## Ordering Matrix

Family	Wattage	Color Temp	Finish	Driver Options	Sensor Options	Other Options
ALED5S	150	N		/D10	/7PR	
	78 = 78W 150 = 150W	Blank = 5000K Cool N = 4000K Neutral Y = 3000K Warm	Blank = Bronze W = White	/D10 = 120-277V, 0-10V Dimming /480/D10 = 480V, 0-10V Dimming /BL = Bi-Level	Blank = No Option /PCT = 120-277V Twistlock Photocell /PCT4 = 480V Twistlock Photocell /WS2 = Motion Sensor/Photocell /LC = Lightcloud® Controller /5PR = 5 Pin Receptacle /7PR = 7-Pin Receptacle /7PR/WS2 = 7-Pin Receptacle w/ Motion Sensor	Blank = Standard USA = BAA Compliant