



UPC: 192552005333

Color: Clear

Weight: 0.1 lbs

Project:	Type:
Prepared By:	Date:

Technical Specifications

Performance

Product Type:

A-Line

Input Wattage:

13.5W

Lumens (Nominal):

1,600lm

Efficacy:

118.5lm/W

L70 Lifespan:

15,000-Hour LED lifespan based on IES LM-70 results

Wattage Equivalency:

100W Incandescent

Compliance

Enclosed Fixtures:

Suitable for use in enclosed fixtures

LED Characteristics

Color Temperature:

3000K

Color Accuracy (CRI):

>90 CRI

Electrical

Power Factor:

>0.7

Dimmable:

Yes

Flicker:

<30%

Operating Temperature:

-20°C to 45°C (-4°F to 113°F)

Input Voltage:

120V

Operating Frequency:

50/60Hz

Construction

Bulb Shape:

A19

Base Type:

E26 Edison

Endcap Material:

Nickel-Aluminum

Enclosure Material:

Glass

Optical

Beam Angle:

360°

Other

Warranty:

RAB warrants that our LED products will be free from defects in materials and workmanship for a period of three (3) years from the date of delivery to the end user, including coverage of light output, color stability, driver performance and fixture finish. RAB's warranty is subject to all terms and conditions found at rablighting.com/warranty.

Buy American Act Compliance:

RAB values USA manufacturing! Upon request, RAB may be able to manufacture this product to be compliant with the Buy American Act (BAA). Please contact customer service to request a quote for the product to be made BAA compliant.

Case and Pallet Dimensions

	QTY	LENGTH (in)	WIDTH (in)	HEIGHT (in)
CASE	12	10.8	8.1	11
PALLET	1080	44.09	38.74	26.67

Dimension

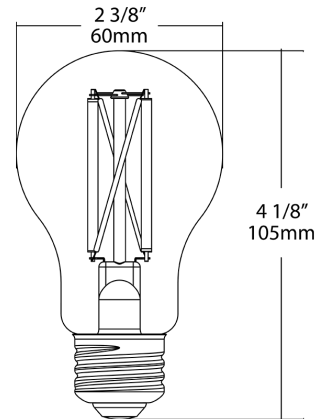

Features

- Replacement for conventional decorative lamps
- Filament LED construction gives a unique traditional look and feel for decorative and ambient applications
- Produces rich and vibrant colors, >90CRI
- Rated for use in enclosed and open fixtures in dry and damp locations
- Longer lifespan compared to legacy equivalents minimizes replacement and maintenance costs
- Title 20 Compliant, ENERGY STAR Compliant, UL Listed
- Smooth uniform dimming down to 10% (See Dimmer Compatibility List)

Ordering Matrix

Family	Wattage	Base Type	CRI/Color Temp	Type	Finish
A19	13	E26	930	F	C
	5 = 5W 9 = 9W 10 = 10W 13 = 13W	E26 = E26	950 = 90 CRI, 5000K 940 = 90 CRI, 4000K 930 = 90 CRI, 3000K 927 = 90 CRI, 2700K	F = Filament	C = Clear F = Frosted