



UPC: 192552005364

Color: Clear

Weight: 0.1 lbs

Project:	Type:
Prepared By:	Date:

**Technical Specifications**

**Performance**

**Product Type:**

A-Line

**Input Wattage:**

13.5W

**Lumens (Nominal):**

1,600lm

**Efficacy:**

118.5lm/W

**L70 Lifespan:**

15,000-Hour LED lifespan based on IES LM-70 results

**Wattage Equivalency:**

100W Incandescent

**Compliance**

**Enclosed Fixtures:**

Suitable for use in enclosed fixtures

**LED Characteristics**

**Color Temperature:**

2700K

**Color Accuracy (CRI):**

>90 CRI

**Electrical**

**Power Factor:**

>0.7

**Dimmable:**

Yes

**Flicker:**

<30%

**Operating Temperature:**

-20°C to 45°C (-4°F to 113°F)

**Input Voltage:**

120V

**Operating Frequency:**

50/60Hz

**Construction**

**Bulb Shape:**

A19

**Base Type:**

E26 Edison

**Endcap Material:**

Nickel-Aluminum

**Enclosure Material:**

Glass

**Optical**

**Beam Angle:**

360°

**Other**

**Warranty:**

RAB warrants that our LED products will be free from defects in materials and workmanship for a period of three (3) years from the date of delivery to the end user, including coverage of light output, color stability, driver performance and fixture finish. RAB's warranty is subject to all terms and conditions found at [rablighting.com/warranty](http://rablighting.com/warranty).

**Buy American Act Compliance:**

RAB values USA manufacturing! Upon request, RAB may be able to manufacture this product to be compliant with the Buy American Act (BAA). Please contact customer service to request a quote for the product to be made BAA compliant.

### Case and Pallet Dimensions

	QTY	LENGTH (in)	WIDTH (in)	HEIGHT (in)
CASE	12	10.8	8.1	11
PALLET	1080	44.09	38.74	26.67

### Dimension

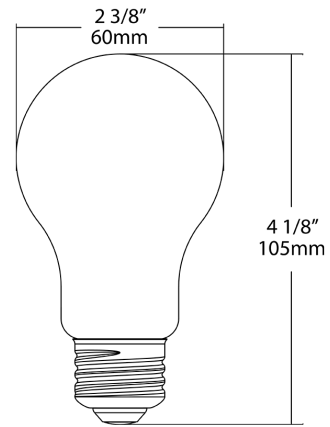

### Features

- Replacement for conventional decorative lamps
- Filament LED construction gives a unique traditional look and feel for decorative and ambient applications
- Produces rich and vibrant colors, >90CRI
- Rated for use in enclosed and open fixtures in dry and damp locations
- Longer lifespan compared to legacy equivalents minimizes replacement and maintenance costs
- Title 20 Compliant, ENERGY STAR Compliant, UL Listed
- Smooth uniform dimming down to 10% (See Dimmer Compatibility List)

### Ordering Matrix

Family	Wattage	Base Type	CRI/Color Temp	Type	Finish
A19	13	E26	927	F	F
	5 = 5W 9 = 9W 10 = 10W 13 = 13W	E26 = E26	950 = 90 CRI, 5000K 940 = 90 CRI, 4000K 930 = 90 CRI, 3000K 927 = 90 CRI, 2700K	F = Filament	C = Clear F = Frosted