



Color: Bronze

Weight: 11.5 lbs

Project:	Type:
Prepared By:	Date:

Driver Info		LED Info	
Type	Constant	Watts	200/180/160W
120V	/480	Color Temp	3000K/4000K/5000K
208V	N/A	Color	81-83 CRI
240V	N/A	Accuracy	
277V	N/A	L70 Lifespan	100,000 Hours
Input Watts	156.3-199.3W	Lumens	25,165-32,276 lm
		Efficacy	150.1-170.7 lm/W

Technical Specifications

Compliance

UL Listed:

Suitable for wet locations

IESNA LM-79 & LM-80 Testing:

RAB LED luminaires and LED components have been tested by an independent laboratory in accordance with IESNA LM-79 and LM-80.

IP Rating:

Ingress protection rating of IP65 for dust and water

DLC Listed:

This product is listed by Design Lights Consortium (DLC) as an ultra-efficient premium product that qualifies for the highest tier of rebates from DLC Member Utilities. Designed to meet DLC 5.1 requirements.

DLC Product Code: S-LJK45J (Architectural Flood and Spot Luminaires)

DLC Product Code: S-303SN0 (Outdoor Pole/Arm-Mounted Area and Roadway Luminaires)

Electrical

Driver:

200W: Constant Current, Class 1, 480V, 50/60 Hz, 480V: 0.41A

180W: Constant Current, Class 1, 480V, 50/60 Hz, 480V: 0.39A

160W: Constant Current, Class 1, 480V, 50/60 Hz, 480V: 0.34A

Dimming Driver:

Driver includes dimming control wiring for 0-10V dimming systems. Requires separate 0-10V DC dimming circuit. Dims down to 10%.

THD:

9.55% at 480V

Power Factor:

95.49% at 480V

Surge Protection:

6kV

3-Pin Receptacle with Shorting Cap:

ANSI C136.41 3-pin receptacle, compatible with wireless control systems

Performance

Lifespan:

100,000-Hour LED lifespan based on IES LM-80 results and TM-21 calculations

Construction

IES Classification:

The Type V distribution produces light in a wide and uniform 360° pattern that is perfect for large outdoor areas such as parking lots, corporate parks and retail settings

Cold Weather Starting:

The minimum starting temperature is -40°C (-40°F)

Maximum Ambient Temperature:

Suitable for use in up to 40°C (104°F)

Lens:

Polycarbonate lens

Housing:

Die-cast aluminum housing, lens frame and mounting arm

Vibration Rating:

3G vibration rating per ANSI C136.31

Effective Projected Area (Without Shield):

1 Fixture: 0.72 ft²

2 Fixtures at 90°: 1.04 ft²

2 Fixtures at 180°: 1.43 ft²

3 Fixtures at 90°: 1.76 ft²

4 Fixtures at 90°: 1.76 ft²

Effective Projected Area (With Shield):

1 Fixture: 0.75 ft²

2 Fixtures at 90°: 1.39 ft²

2 Fixtures at 180°: 1.5 ft²

3 Fixtures at 90°: 2.15 ft²

4 Fixtures at 90°: 2.15 ft²

Technical Specifications (continued)

Mounting:

Universal mounting arm compatible for hole spacing patterns from 1" to 5 1/2" center to center. Round Pole Adaptor plate included as a standard. Easy slide and lock to mount fixture with ease. Round pole diameter must be >4" to mount fixtures at 90° orientation.

Finish:

Formulated for high durability and long-lasting color

Green Technology:

Mercury and UV free. RoHS-compliant components.

LED Characteristics

LEDs:

Long-life, high-efficiency, surface-mount LEDs

Color Uniformity:

RAB's range of Correlated Color Temperature follows the guidelines of the American National Standard for Specifications for the Chromaticity of Solid State Lighting (SSL) Products, ANSI C78.377-2017.

Other

5 Yr Limited Warranty:

The RAB 5-year, limited warranty covers light output, driver performance and paint finish. RAB's warranty is subject to all terms and conditions found at rablighting.com/warranty.

Buy American Act Compliance:

RAB values USA manufacturing! Upon request, RAB may be able to manufacture this product to be compliant with the Buy American Act (BAA). Please contact customer service to request a quote for the product to be made BAA compliant.

Optical

BUG Rating:

B4 U0 G2

Dimensions

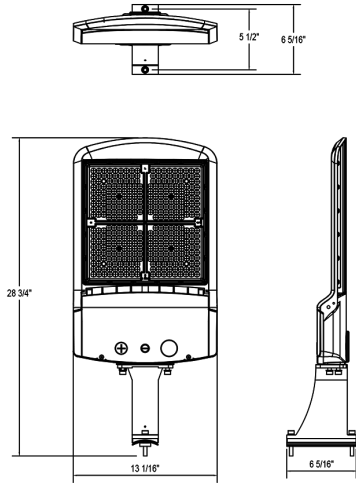

Features

- 0-10V Dimming, standard
- 100,000-hour LED lifespan
- 5-Year, limited warranty

Ordering Matrix

Family	Distribution	Wattage/Lumens	Mounting	Color Temp	Finish	Voltage	Options
A17	-	5T	200			/480	/3PRS
	4T = Type IV 5T = Type V 3T = Type III	70 = 70/60/50W 100 = 100/80/60W 150 = 150/120/100W 200 = 200/180/160W 300 = 300/240/200W 375 = 375/300/240W 480 = 480/400/320W	SF = Slipfitter (Factory installed SF available in 150W) Blank = Universal Pole Mount	Blank = 3000K/4000K/5000K CCT Adjustable	Blank = Bronze	Blank = 120-277V, 0-10V Dimming /480 = 480V, 0-10V Dimming	Blank = No Option /3PRS = 3-pin Receptacle and Shorting Cap /7PRS = 7-pin Receptacle and Shorting Cap /MVS = Microwave Motion Sensor /LCBS = Lightcloud Blue Enabled w/PIR Sensor /LCBS/MVS = Lightcloud Blue Enabled w/MVS Sensor

¹ 480V driver available standard on 150W and 300W and by special order on 100, 240 and 375W. Not available on 70W or 200W models.

Type II distribution available as special order

Wall mount and adjustable universal pole mount available as optional field-installed accessories