

LT4S INSTALLATION INSTRUCTIONS LT4S OVERALL DIMENSIONS

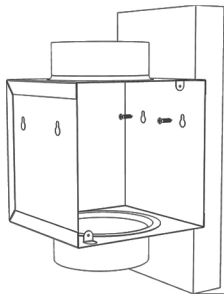

Mount the LT4S metal box to a stud with two screws (not supplied)

STEP 1

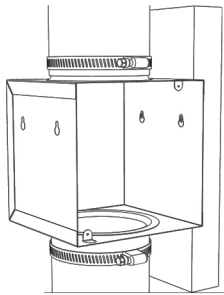

Install duckwork to each end collar and secure it with duct clamps. (do not use screws to fix the ductwork)

STEP 2

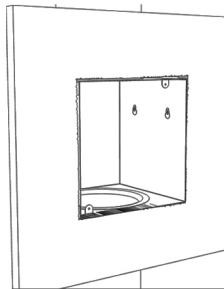

Install drywall and cut it along the edge of the box. The front edge of the metal box should be flush with the surface of the drywall.

STEP 3

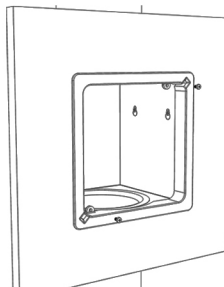

Install the finishing frame to the box with the two stainless steel supplied screws.

STEP 4

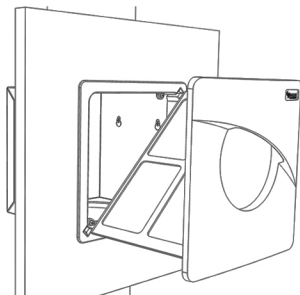

Insert the screen / door assembly by aligning the screen in the finishing frame as shown.

STEP 5

The Lint Trap should always be inspected and cleaned before the use of the dryer, as this will decrease drying times and help prevent any hazardous lint build-up.

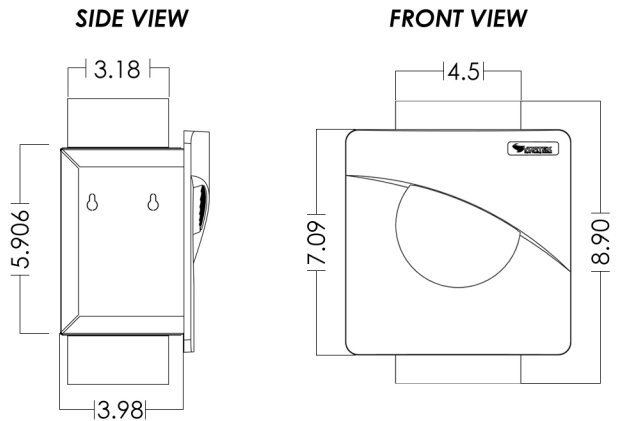

LT4S FEATURES

- Finishing frame for a quick installation and esthetic finish
- 4" oval adapter design to fit in to a 4" deep wall.
- Powder coated metal box to prevent any rust
- 100 mm window for visual monitoring of lint build-up
- (UL 94 V-0) flame resistant polymer material construction.
- Washable nylon mesh for a better filtration of small lint particles
- Compatible with 1/2" and 5/8" drywall

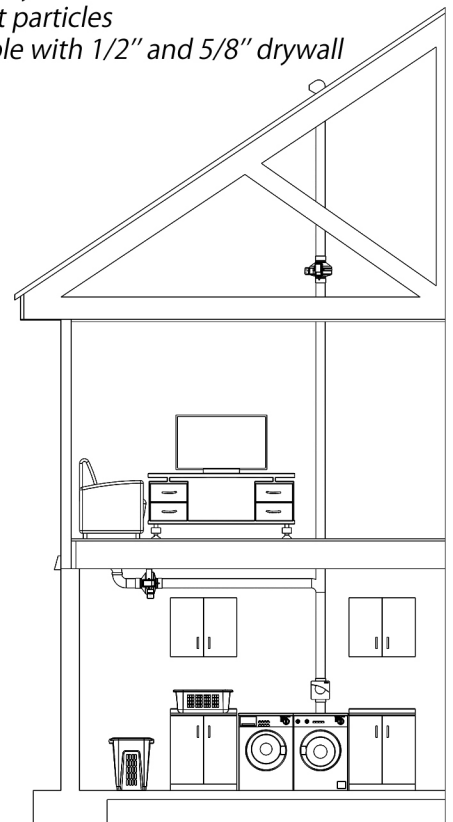

VORTEX
 Dryer Venting Solution
 WWW.ATMOSPHERE.COM