

Intelli-Balance® 100 Energy Recovery Ventilator

Intelli-Balance® 100

FV-10VEC2R (Any Climate Mirror Model)
FV-10VEC2 (Cold Climate)
FV-10VE2 (Temperate Climate)



HEALTHY AIR, HEALTHY HOME

True Flow ratings at **0.4"** static pressure provide powerful airflow to assure code compliant, healthy homes¹

[See PQ Curves]



- **New!** FV-10VEC2R model to complete the series with a Single Family Residential or Multi-Family Residential application that requires a mirrored (reverse) model.
- Occupant controllable Boost function. Moves fan speed to high when activated.
- Designed for multi-family dwellings and new air tight homes built to meet energy efficiency standards
- Engineered for use in any North America Climate Zone
- Two (2) powerful ECM motors with Smart Flow™ technology ensure optimum airflow by overcoming static pressure to effectively remove contaminated air and replace it with fresh air
- Multi-speed selector (50 to 100 CFM) provides customizable airflow to create balanced, positive or negative pressure for supply and exhaust motor within the residential and commercial spaces
- Highest energy recovery efficiency performer in the 150 CFM and under ERV class
- Core material permeated with anti-mold treatment to help prevent mold
- Exclusive built-in ASHRAE 62.2 timing function helps ensure code compliance and simplifies the installation process
- MERV 8 filter included; MERV 8 and optional MERV 13 replacements available
- Connect to existing ductwork or use as a standalone, whole-house ventilation solution
- Can be used to meet Green Building Code requirements and contribute to better HERS/ERI scores

ADDITIONAL BENEFITS

- High efficiency exchange capillary core recovers heat and balances moisture, inside to outside
- Two mounting options - wall or ceiling
- Separate control of supply and exhaust airflow. Four integrated dual 4" or 6" duct adapters (2 exhaust, 2 supply)
- Includes static pressure access ports with balancing instructions on the ERV for simplified installation
- Model FV-10VEC2R and FV-10VEC2 meet Ontario, ENERGY STAR®² and Novoclimat requirements³
- 6 Year Warranty on ECM motor, 3 Years on all other parts

¹ Highest CFM rating for supply and exhaust at 0.4 static pressure

² Meets strict energy efficiency guidelines set by Natural Resources Canada and is ENERGY STAR® certified for the Canadian market only

³ Meets established energy efficiency standards in Canada for climate Zone 1 - fewer than 6,000 heating degree days (HDD)

The power of performance, with exclusive smart sensing technology

Intelli-Balance[®] 100



FV-10VEC2R² (Any Climate Mirror Model)
FV-10VEC2² (Cold Climate)
FV-10VE2 (Temperate Climate)



²Meets strict energy efficiency guidelines set by Natural Resources Canada and is ENERGY STAR[®] certified for the Canadian market only.

COST EFFECTIVE, CODE COMPLIANT ERV FOR ANY CLIMATE ZONE

Intelli-Balance[®] 100 is a powerful, high performance, high efficiency Energy Recovery Ventilator (ERV) that's designed to help you meet ASHRAE 62.2 requirements. This unique and cost effective ERV was engineered for total versatility and installation flexibility, in any climate zone. Built-in controls minimize the time it takes to determine desired airflow, as well as verify and maintain performance. Intelli-Balance[®] 100 allows you to simply design and specify your ventilation system requirements, improve IAQ and reduce ventilation costs.



BALANCED VENTILATION

Tightly built homes and buildings utilizing exhaust only fans can create negative pressure. Intelli-Balance[®] 100 solves this by supplying air to replace exhausted air, helping to balance air pressure within the home.

Panasonic Intelli-Balance[®] 100 ERV uses four integrated dual 4" or 6" round duct adaptors – two adaptors to exhaust stale air and two other adaptors to supply fresh air. Panasonic Intelli-Balance[®] 100 ERV's low, continuous run helps remove moist, stale air and replace it with fresh air. Air changes per hour have been shown to reduce virus and bacteria counts in the air.

Intelli-Balance[®] 100 can be ceiling or wall mounted, does not require connection to the Central HVAC or the addition of a condensation line. This allows it to be installed in many places throughout the home to meet IAQ, health and comfort needs.

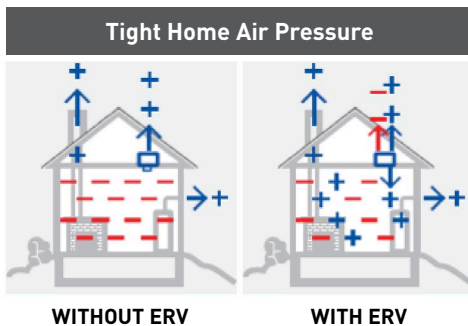

ECM MOTOR TECHNOLOGY

Intelli-Balance[®] 100 uses two (2) ECM brushless motors with built-in SmartFlow[™] technology for precision ventilation. When the ERV senses static pressure, its speed is automatically increased to ensure optimal CFM output; regardless of a complicated duct run. This feature provides peace of mind, as the installer doesn't have to worry about compromising the ERV's performance. Both ECM motors are rated for continuous run and are totally enclosed to ensure long-life and continuous, quiet operation. Each motor is equipped with a thermal cutoff fuse.

MULTI-SPEED SELECTOR

Intelli-Balance[®] 100 includes a built-in Multi-speed selector that provides the unique ability to select your required supply (50-60-70-80-90-100 CFM) and exhaust airflow (50-60-70-80-90-100 CFM), with the simple turn of a dial. This truly customizable airflow capability allows you to create balanced, positive or negative pressure within the home.

ASHRAE 62.2 INTERMITTENT TIMING FUNCTION

The adjustable Minutes Per Hour (Min/Hr) timer allows the user to set the number of minutes per hour the ERV should run. This gives scalability of air flow relative to property size; from the smallest multi-family to larger single family applications. This ensures consistent and controlled ventilation throughout the day for compliance with ASHRAE 62.2. Factory default setting is 60 Min/Hr.

Built-In Controls

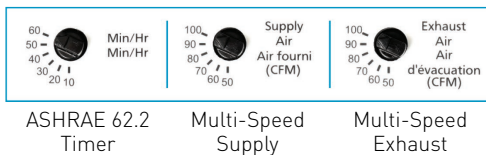

Key improvement features

Added a jumper cable at the wall switch terminal on the fan.

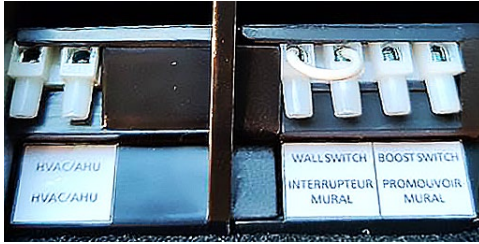

Accessories (Sold Separately):

FV-FL0810VE1: Supply Air (SA) MERV 8 Replacement Filter

FV-FV1310VE1: MERV 13 Optional Replacement Filter



Supply Air Filter (SA) (MERV 8 included, MERV 13 Optional)

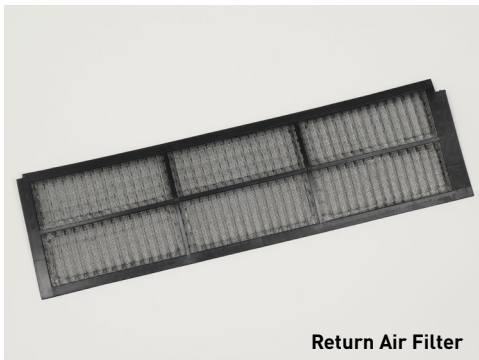

Return Air Filter

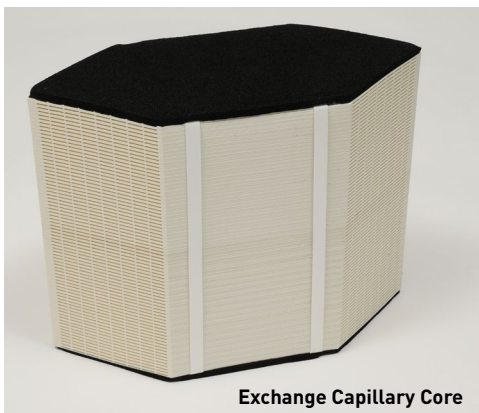

Exchange Capillary Core

FILTERS & MAINTENANCE

Intelli-Balance® 100 has two filters that clean the exhaust and supply air before passing through the ERV core, extending the life of the core. A hinged access panel allows for quick and easy product maintenance and filter checks. Convenient light indicator and unobtrusive alarm signal on the access panel will help inform the homeowner when it's time to check and clean the filters. Both filters should be vacuumed with a soft brush attachment every 2-3 months or as needed, and the supply air filter should be inspected every 90 days and replaced every 6 months to maintain the ERV's peak performance.

ENTHALPIC TRANSFER CORE

Indoor and outdoor air pass through Panasonic's patented capillary core designed to transfer heat and moisture. This process tempers supply air while balancing moisture levels inside to outside. The core's high latent energy (moisture) transfer makes Intelli-Balance 100 ideal for use in most climate zones, as it helps expel moisture during incidences of high relative humidity (RH) and helps return moisture back inside during the winter for a healthier, more comfortable living environment. Core material permeated with anti-mold treatment to help prevent mold in the home.

WHOLE HOUSE ERV

Intelli-Balance® 100 is a ceiling or wall mount Energy Recovery Ventilator (ERV) that's ideal for meeting whole house ventilation requirements under ASHRAE 62.2. Intelli-Balance® 100 is also an ideal choice when partnered with mini-splits or VRF Heat Pumps for fresh, balanced air with energy recovery which makes it a very affordable, cost-effective IAQ solution.

Ideal for: Single Family Homes (≤ 3,000 sq. ft., up to 7 bedrooms) / Condominiums / Apartments / Housing Authority Properties / Hotels / Studio apartments.

ASHRAE 62.2 2010 AND 2013 STANDARD

The American Society of Heating, Refrigerating and Air Conditioning Engineers (ASHRAE) set a standard for whole house ventilation, requiring that continuous mechanical ventilation be 7.5 CFM per bedroom (master bedroom X 2) plus 1 CFM per 100 square feet, with zones not to exceed 1.0. ASHRAE 62.2-2013 requires a ventilation rate of 7.5 CFM per person plus 3 CFM per 100 square feet. Please check with your local jurisdiction to determine which ventilation standard you should follow. Panasonic Intelli-Balance® 100 ERV is an affordable, efficient way to meet the ASHRAE 62.2 standard.

OPERATION

FV-10VEC2R is your go-to for residential single family applications where you have flexibility with the ducting configuration. Suitable for any climate zone in the US, this model the stocking distributors choice to simplify the decision for national distribution when the product could go to any climate zone. All of the features necessary for optimal operation in any climate zone are the same as the FV-10VEC2 and this model offers the shortest lead time of all models.

FV-10VEC2 is recommended for areas where temperatures can drop as low as -22°F (-30°C). When the outdoor temperature is < -22°F (-30°C), the defrost cycle is initiated and the product will stop operating for 47 minutes, then operate in heat exchange mode for 4 minutes in order to sample the outdoor temperature. It then operates in circulation mode for 9 minutes in order to defrost (exhaust and supply air are 50 CFM). Defrost cycle overrides the ASHRAE 62.2 timing function.

FV-10VE2 is recommended for areas where temperatures can drop as low as 14°F (-10°C). When the outdoor temperature is < 14°F (-10°C), the defrost cycle is initiated and the product will stop operating for 56 mins, then operate in heat exchange mode for 4 minutes in order to sample the outdoor temperature (exhaust and supply air are 50 CFM). Defrost cycle overrides the ASHRAE 62.2 timing function.

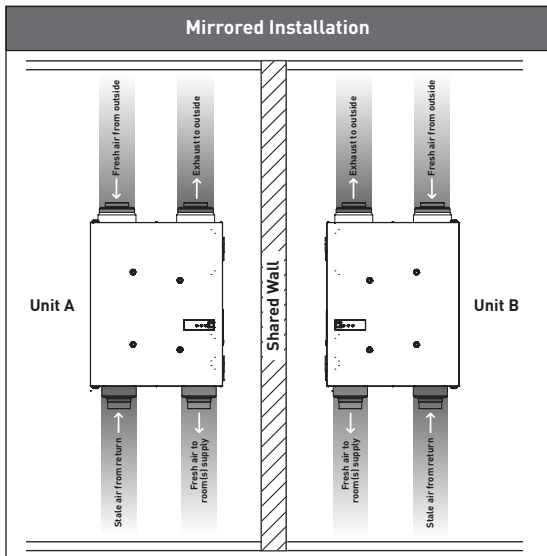

Intelli-Balance Accessory Kits					
Model No.	Description	Inlet Grille	Backdraft Damper	Clamp	Y-Adapter
FV-NLF04G	4" Inlet Grille + Metal Plate	1 (4")	-	-	-
FV-NLF06G	6" Inlet Grille + Metal Plate	1 (6")	-	-	-
PC-NLF04S	4" Single Inlet Kit	1 (4")	1 (4")	6	-
PC-NLF06S	6" Single Inlet Kit	1 (6")	1 (6")	6	-
PC-NLF04D	4" Double Inlet Kit	2 (4")	2 (4")	12	1 (4"- 4" x 2)
PC-NLF06D	6" Double Inlet Kit	2 (6")	2 (6")	12	1 (6"- 6" x 2)
PC-NLF64D	6"- 4" Double Inlet Kit	2 (4")	2 (4")	12	1 (6"- 4" x 2)
PC-NLF86Y	8"- 6" Y-Adapter	-	-	-	1 (8"- 6" x 2)
FV-NLF46RES	Recessed Inlet integrated dual 4" or 6" duct adaptor	-	-	-	-
EZSV14	Soffit Termination System	-	-	-	-

Intelli-Balance 100 Family

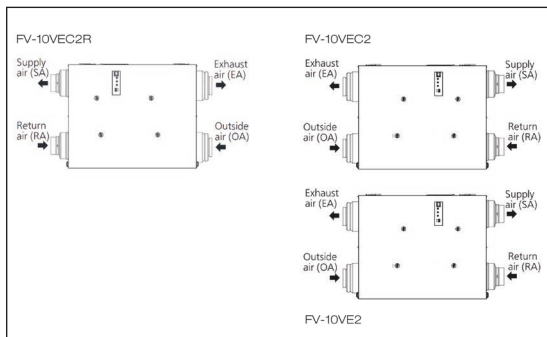

INSTALLATION

Mounting: Intelli-Balance® 100 can easily be mounted in the ceiling or on a wall using the included cleat hanger bar. It measures 23" wide and fits between joists 16" on center. Intelli-Balance® 100 can also be chain mounted and suspended. Adjustable brackets and screws are provided to secure the unit to the joist on 4 corners.

Wiring: Power consumption is 81 Watts on all models, with a power rating of 120/60 V/Hz.

Duct: Insulated 4" or 6" duct is recommended.

Static Pressure Access Ports: The unit's access panel incorporates static pressure ports for measuring the differential pressure of fresh air and exhaust air so the dampers can be adjusted for balancing airflows.

Intelli-Balance 100	FV-10VEC2R/FV-10VEC2/FV-10VE2	
Characteristics	COLD/TEMPERATE CLIMATE	
Static pressure in inches w.g.	0.1	0.4
Net Exhaust Air Volume (CFM)	100	100
Net Supply Air Volume (CFM)	100	100
Power Consumption (Watts)	81	100
Power Rating (V/Hz)	120/60	
ENERGY STAR® Certified	YES	

FV-10VEC2R/FV-10VEC2

Supply Temperature		Net Air Flow		Power Consumed (Watts)	Sensible Recovery Efficiency	Apparent Sensible Effectiveness	Net Moisture Transfer
°C	°F	L/S	CFM				
Heating							
0	32	25	53	29	80	83	0.78
0	32	31	66	39	77	81	0.74
0	32	40	85	68	73	77	0.71
-25	-13	27	57	77	65	67	0.71
-25	-13	30	64	100	56	60	0.58
Cooling							
35	95	23	49	32	Total Recovery Efficiency		60

FV-10VE2

Supply Temperature		Net Air Flow		Power Consumed (Watts)	Sensible Recovery Efficiency	Apparent Sensible Effectiveness	Net Moisture Transfer
°C	°F	L/S	CFM				
Heating							
0	32	25	53	29	80	83	0.78
0	32	31	66	39	77	81	0.74
0	32	40	85	68	73	77	0.71
Cooling							
35	95	23	49	32	Total Recovery Efficiency		60

Intelli-Balance 100 Airflow Performance Curve 4" or 6" Ducts

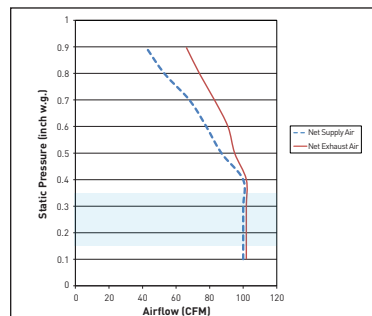

Intelli-Balance 100 Dimensions

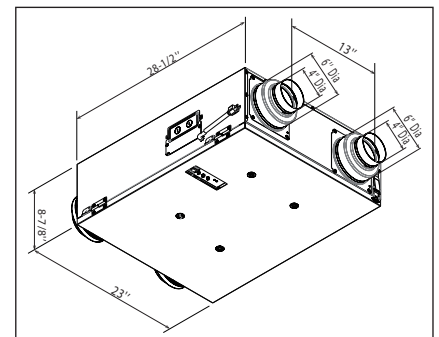

Panasonic IAQ Division
Two Riverfront Plaza
Newark, NJ 07102
na.panasonic.com/us/iaq

For Order Information
PHONE: 866-292-7299
FAX: 888-553-0723
ventfans@us.panasonic.com