

NTRT Series

Recessed Track Housing

Type
Project
Catalog No.
Notes

PRODUCT DESCRIPTION

This system is designed for use with Nora 1-circuit (NT-300 Series) or 2-circuit (NT-2300 Series) track. The extruded aluminum housing is mounted into the ceiling cavity which allows for flush installation of the track system to any style of ceiling.

SPECIFICATION

Construction: System components are extruded aluminum finished in White or Black to match Nora Track.

INSTALLATION

Each installation will vary based on ceiling make up. All mounting hardware is provided for installation finishing to drywall or suspended ceilings. Hardware included may not meet all installation requirements. Additional framing may be required in some hard ceiling applications. Spacers are supplied with NTRT-4 and NTRT-8 to adjust for thickness of single or 2-circuit track.

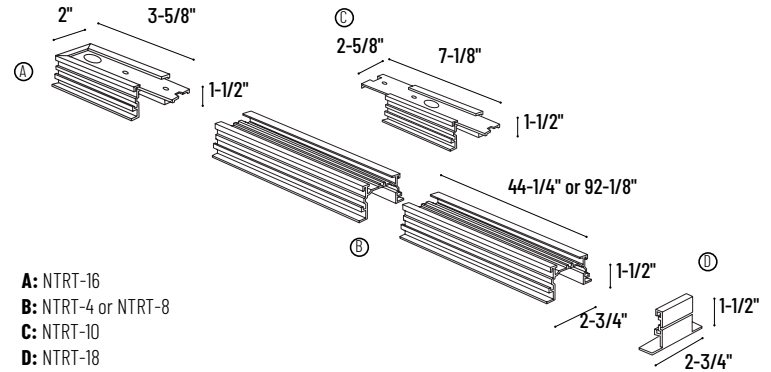

NTRT-13

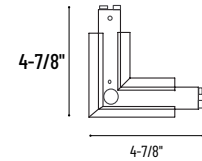
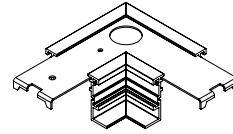

NTRT-14

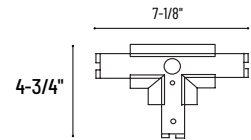
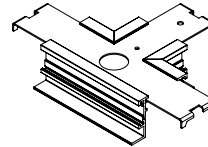

NTRT-15

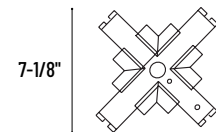
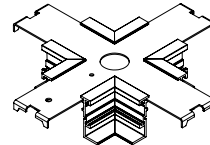

Recessed Housing for Track

Recessed Track Housing	Finish
NTRT-4 = 4' length	B = Black W = White
NTRT-8 = 8' length	BA = Black WA = White

Connectors and Accessories for Recessed Housing

Connectors and Accessories	Finish
NTRT-10 = Straight Connector	B = Black W = White
NTRT-13 = L-Connector	W = White
NTRT-14 = T-Connector	
NTRT-15 = X-Connector	
NTRT-16 = End Feed	
NTRT-18 = Dead End	

Compatible 1-Circuit Track

One-Circuit Track System	Finish
NT-301 = 2' Track	B = Black W = White
NT-302 = 4' Track	W = White
NT-303 = 6' Track	
NT-304A = 8' Track	
NT-331 = 12' Track	

One-Circuit Track Accessories	Finish
NT-316 = Live End Feed	B = Black W = White
NT-310 = Straight Connector	W = White
NT-312 = I-Connector	
NT-313 = L-Connector	
NT-314 = T-Connector	
NT-315 = X-Connector	

Compatible 2-Circuit Track

Two-Circuit Track System	Finish
NT-2302 = 4' Track	B = Black W = White
NT-2303 = 6' Track	W = White
NT-2304A = 8' Track	
NT-2331 = 12' Track	

Two-Circuit Track Accessories	Finish
NT-2316 = Live End Feed	B = Black W = White
NT-2310 = Straight Connector	W = White
NT-2312 = I-Connector	
NT-2313 = L-Connector	
NT-2314 = T-Connector	
NT-2315 = X-Connector	

Example: **NTRT-4W / NT-302W** = 4' One-Circuit Track and Recessed Housing, White finish