

NM2-2RTLDC

2" M2 Trimless LED Downlight

Source: 8W or 10W LED
750lm or 900lm

Type

Project

Catalog No.

Notes

PRODUCT DESCRIPTION

2" M2 trimless downlights features quality and convenience with easy installation for insulated or non-insulated applications. Each installation requires a mud plate that mounts to drywall and hold LED luminaire to ceiling without any housing.

FEATURES

- No housing required - IC Air-Tight rated
- Easy installation for remodel or new construction applications
- Trimless mud plate required (NM2-TLMR-R)
- Quick disconnect allows for extended lengths
- Delivering up to 900 lumens
- 2700K, 3000K or 4000K @ 90+ CRI
- Triac or ELV dimming
- 5-year limited warranty
- ENERGY STAR certified
- cETLus Listed for Damp Locations

SPECIFICATION

Construction: Die-cast aluminum trims available in matte black or matte powder white finish.

Air Flow Restriction: Luminaire has factory installed gasket to restrict airflow from room into ceiling plenum to <2CFM (cubic feet per minute) in accordance with ASTM-283 Air-Tight requirements.

Clearance: IC rated luminaires are rated for direct contact with insulation (not spray foam insulation), no minimum clearance is required.

Junction Box: Pre-wired junction box includes quick connect to LED fixtures for ease of installation. Junction box includes two ½" trade size knockout and snap on cover with 18" quick connect wire. Luminaire includes 6" quick connect wire.

Mounting: No housing is required, patent pending mud plate (ordered separately) secures luminaire to ceiling.

ELECTRICAL

Input Voltage: 120V

Lumens / Wattage: 750lm / 8W or 900lm / 10W

Color Temperature: 2700K, 3000K or 4000K

Color Rendering Index: 90+ CRI

Operating Temperature: 0-30°C

Dimming: Triac or ELV

[Click Here](#) or check complete dimmer list at www.NoraLighting.com in the "Compatibility" page under "Resources" tab

ACCESSORIES

[NM2-TLMR-R](#): Trimless Mud Plate (required)

[NF-R246](#): Universal New Construction Frame-In (optional)

[NFC-R275](#): New Construction Frame-In with Collar (optional)

[NMA-EW-4](#): 4' Quick Connect Linkable Extension Cable (optional)

[NMA-EW-10](#): 10' Quick Connect Linkable Extension Cable (optional)

LABELS AND LISTINGS

- cETLus Listed for Damp Locations
- ENERGY STAR certified
- [5-Year Limited Warranty](#)
- FCC compliant
- Certified to the high efficacy requirements of California Title 24 JA8-2022



Performance Data

Part Number	Lumens	CCT
NM2-2RTLDC6027MPW	700lm	2700K
NM2-2RTLDC8527MPW	817lm	2700K
NM2-2RTLDC6030MPW	746lm	3000K
NM2-2RTLDC8530MPW	843lm	3000K
NM2-2RTLDC6040MPW	774lm	4000K
NM2-2RTLDC8540MPW	935lm	4000K

Delivered lumens will vary depending on finish

PRODUCT IMAGES AND DIMENSIONS

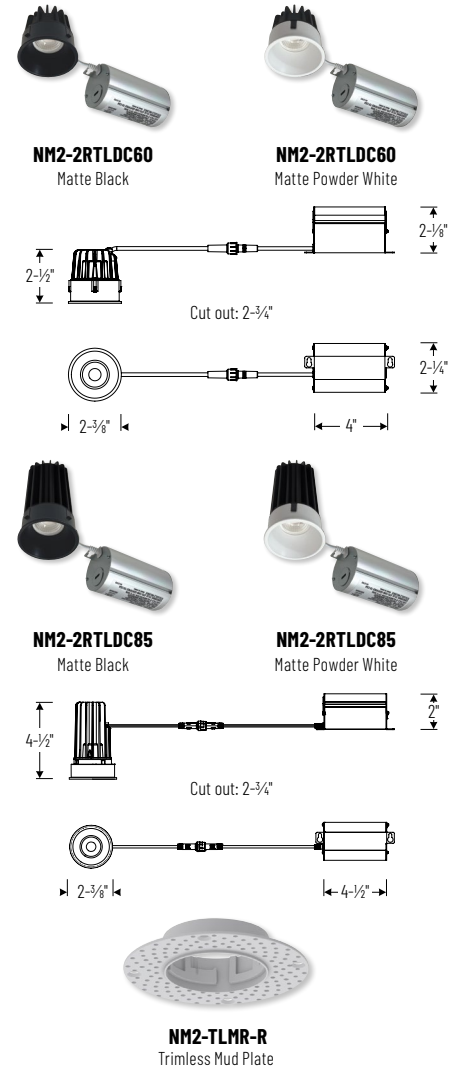

2" M2 Trimless LED Downlight

Description	Lumens / Wattage	Color Temperature	Finish
NM2-2RTLDC = 2" M2 Trimless	60 = 750lm / 8W	27 = 2700K	BB = Matte Black
	85 = 900lm / 10W	30 = 3000K	MPW = Matte Powder White
		40 = 4000K	

2" M2 Trimless Mud Plate (Required)

Description
NM2-TLMR-R = Trimless Mud Plate

Optional Extension Cables

Description
NF-R246 = Universal New Construction Frame-In
NFC-R275 = New Construction Frame-In with Collar
NMA-EW-4 = 4' Quick Connect Extension Cable
NMA-EW-10 = 10' Quick Connect Extension Cable

Example: **NM2-2RTLDC6030MPW** / **NM2-TLMR-R** = 2" M2 Trimless LED Downlight, 750lm / 8W, 3000K, Matte Powder White

NM2-2RTLDC

2" M2 Trimless LED Downlight Accessories

Type	_____
Project	_____
Catalog No.	_____
Notes	_____

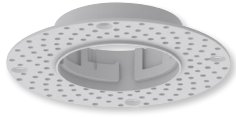

Trimless Mud Plate

NM2-TLMR-R

Mounts trimless downlight with no exposed flange and no extension beyond ceiling plane.



Universal New Construction Frame-In

NF-R246

Universal new construction frame-in can be used to assist installing can-less recessed downlighting.



New Construction Frame-In with Collar

NFC-R275

New construction frame-in can be used to assist installing can-less recessed downlighting.



Quick Connect Extension Linkable Cables

NMA-EW-4

4' Cable

NMA-EW-10

10' Cable

Use to extend the length between luminaire and driver enclosure. Can be connected together to create custom lengths. Maximum length between luminaire and driver is 40'.

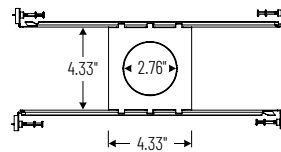
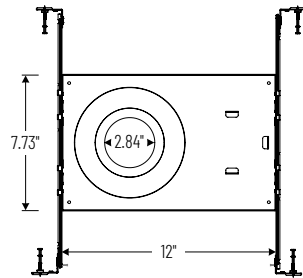

PHOTOMETRICS

2" M2 Trimless LED Downlight , 750lm / 8W

Type

Project

Catalog No.

Notes

Test Information

Test Number: NTR2004R1
 Part Number: NM2-2RTLDC6027MPW
 Beam Spread: 42° Narrow Flood
 Lumens: 700lm
 Wattage: 7.86W
 Efficacy: 89lpw
 CCT / CRI: 2700K / 90 CRI
 Spacing Criteria (0°-180°): 0.7
 Spacing Criteria (90°-270°): 0.68

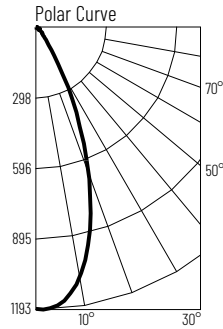

Illuminance at a Distance

Distance from Luminaire	FC at Nadir	Beam Diameter
4'	74.4fc	3'-1"
6'	33fc	4'-7"
8'	18.6fc	6'-2"
10'	11.9fc	7'-8"
12'	8.3fc	9'-4"

Zonal Lumen Summary

Zone	Lumens	% Luminaire
0-30	543	77.7
0-40	617	88.1
0-60	679	97.1
0-90	700	100
90-180	0	0
0-180	700	100

Candela Table

Vertical Angles	Candela
0	1190
5	1163
15	873
25	422
35	109
45	43

Test Information

Test Number: NTR2005R1
 Part Number: NM2-2RTLDC6030MPW
 Beam Spread: 43° Narrow Flood
 Lumens: 746lm
 Wattage: 7.83W
 Efficacy: 95lpw
 CCT / CRI: 3000K / 90 CRI
 Spacing Criteria (0°-180°): 0.7
 Spacing Criteria (90°-270°): 0.7

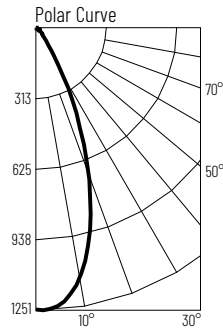

Illuminance at a Distance

Distance from Luminaire	FC at Nadir	Beam Diameter
4'	77.9fc	3'-1"
6'	34.6fc	4'-8"
8'	19.5fc	6'-2"
10'	12.5fc	7'-10"
12'	8.7fc	9'-4"

Zonal Lumen Summary

Zone	Lumens	% Luminaire
0-30	578	77.5
0-40	657	88.1
0-60	725	97.2
0-90	746	100
90-180	0	0
0-180	746	100

Candela Table

Vertical Angles	Candela
0	1246
5	1216
15	938
25	455
35	120
45	47

Test Information

Test Number: NTR2006R1
 Part Number: NM2-2RTLDC6040MPW
 Beam Spread: 44° Narrow Flood
 Lumens: 774lm
 Wattage: 7.76W
 Efficacy: 100lpw
 CCT / CRI: 4000K / 90 CRI
 Spacing Criteria (0°-180°): 0.72
 Spacing Criteria (90°-270°): 0.72

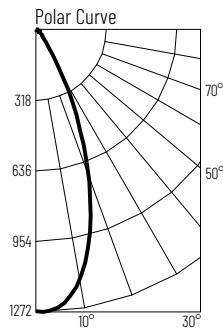

Illuminance at a Distance

Distance from Luminaire	FC at Nadir	Beam Diameter
4'	79.3fc	3'-2"
6'	35.3fc	4'-10"
8'	19.8fc	6'-6"
10'	12.7fc	8'-1"
12'	8.8fc	9'-8"

Zonal Lumen Summary

Zone	Lumens	% Luminaire
0-30	605	78.3
0-40	686	88.6
0-60	752	97.2
0-90	774	100
90-180	0	0
0-180	774	100

Candela Table

Vertical Angles	Candela
0	1269
5	1245
15	990
25	481
35	126
45	46

Lumen Output Multipliers

Finish: Matte Black (0.86), Matte Powder White (1.00)

PHOTOMETRICS

2" M2 Trimless LED Downlight , 900lm / 10W

Type

Project

Catalog No.

Notes

Test Information

Test Number: NTR2127R1
 Part Number: NM2-2RTLDC8527MPW
 Beam Spread: 43° Narrow Flood
 Lumens: 817lm
 Wattage: 9.63W
 Efficacy: 85lpw
 CCT / CRI: 2700K / 90 CRI
 Spacing Criteria (0°-180°): 0.7
 Spacing Criteria (90°-270°): 0.7

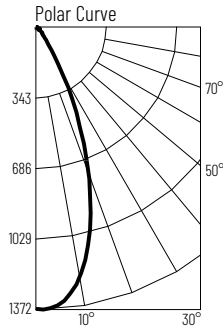

Illuminance at a Distance

Distance from Luminaire	FC at Nadir	Beam Diameter
4'	85.8fc	3'-2"
6'	38.1fc	4'-10"
8'	21.4fc	6'-4"
10'	13.7fc	7'-11"
12'	9.5fc	9'-6"

Zonal Lumen Summary

Zone	Lumens	% Luminaire
0-30	642	78.6
0-40	735	90.0
0-60	796	97.3
0-90	816	100
90-180	0	0
0-180	817	100

Candela Table

Vertical Angles	Candela
0	1372
5	1341
15	1029
25	511
35	136
45	47

Test Information

Test Number: NTR2128R1
 Part Number: NM2-2RTLDC8530MPW
 Beam Spread: 43° Narrow Flood
 Lumens: 843lm
 Wattage: 9.52W
 Efficacy: 89lpw
 CCT / CRI: 3000K / 90 CRI
 Spacing Criteria (0°-180°): 0.7
 Spacing Criteria (90°-270°): 0.7

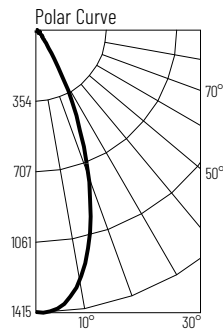

Illuminance at a Distance

Distance from Luminaire	FC at Nadir	Beam Diameter
4'	88.4fc	3'-2"
6'	39.3fc	4'-10"
8'	22.1fc	6'-4"
10'	14.1fc	7'-11"
12'	9.8fc	9'-5"

Zonal Lumen Summary

Zone	Lumens	% Luminaire
0-30	662	78.6
0-40	758	90.0
0-60	820	97.3
0-90	841	99.8
90-180	2	0.2
0-180	843	100

Candela Table

Vertical Angles	Candela
0	1415
5	1382
15	1061
25	526
35	140
45	48

Test Information

Test Number: NTR2129R1
 Part Number: NM2-2RTLDC8540MPW
 Beam Spread: 43° Narrow Flood
 Lumens: 935lm
 Wattage: 9.55W
 Efficacy: 98lpw
 CCT / CRI: 4000K / 90 CRI
 Spacing Criteria (0°-180°): 0.7
 Spacing Criteria (90°-270°): 0.7

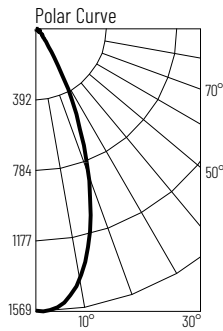

Illuminance at a Distance

Distance from Luminaire	FC at Nadir	Beam Diameter
4'	98.0fc	3'-2"
6'	43.6fc	4'-10"
8'	24.5fc	6'-3"
10'	15.7fc	7'-11"
12'	10.9fc	9'-5"

Zonal Lumen Summary

Zone	Lumens	% Luminaire
0-30	734	78.6
0-40	841	90.0
0-60	910	97.3
0-90	933	99.8
90-180	2	0.2
0-180	935	100

Candela Table

Vertical Angles	Candela
0	1569
5	1533
15	1176
25	584
35	156
45	53

Lumen Output Multipliers

Finish: Matte Black (0.87), Matte Powder White (1.00)