

# NIO-4PSTLNDC

## 4" Iolite PLUS Square Trimless Reflector

Source: 20W to 28W LED  
Up to 2850lm

Type

Project

Catalog No.

Notes

### PRODUCT DESCRIPTION

4" PLUS Trimless Iolite reflectors have no exposed trim flange and do not extend beyond the ceiling plane. Iolite PLUS Trimless requires a PLUS Trimless Mud Ring and PLUS New Construction housing. Deep regressed cone reflectors optimize visual cut-off.

### FEATURES

- Trimless knife edge appearance
- Delivering up to 2850 lumens
- 2700K, 3000K, 3500K, 4000K, 5000K @ 90+ CRI
- Flood optic, narrow flood and spot optics (included)
- 5-Year limited warranty

### SPECIFICATION

**Construction:** Trims are constructed of heat dissipating, die-cast aluminum. Cold forged aluminum LED heat sink is threaded to fit the reflector and transfer heat.

**Mounting:** Luminaire includes stainless steel friction clips to mount securely to trimless mud ring. Mud ring is required per trimless downlight.

### OPTICS

Each luminaire includes field changeable TIR optics (40° spot, 71° flood and 51° narrow flood - preinstalled).

### ELECTRICAL

Delivered Lumens / Wattage	Up to 2100lm / 20W	Up to 2500lm / 24W	Up to 2850lm / 28W
Color Temperature	2700K, 3000K, 3500K, 4000K, 5000K		
Color Rendering Index	90+ CRI		
Compatible Housing	<a href="#">NHIOICD-4PS15</a> <a href="#">NHIOICDCP-4PS15</a>	<a href="#">NHIOICD-4PS20</a> <a href="#">NHIOICDCP-4PS20</a>	<a href="#">NHIOICD-4PS25</a> <a href="#">NHIOICDCP-4PS25</a>
Lifetime	50,000 hours @ L70		

**Accessories:** Luminaires will accommodate (1) translucent deco collar or opaque snoot, no accessory holder is required, see page 2. Mud ring is required ([NIO-TLMR-4PS](#)) per trimless downlight.

### LABELS AND LISTINGS

- cULus Listed for Damp Locations
- ENERGY STAR certified
- [5-Year Limited Warranty](#)
- RoHS Compliant
- Certified to the high efficacy requirements of California Title 24 JA8-2022



### Performance Data

Optic	1500lm	2000lm	2500lm	CCT
<b>Spot</b>	2007lm	2370lm	2728lm	4000K
<b>Narrow Flood</b>	2145lm	2524lm	2880lm	4000K
<b>Flood</b>	1855lm	2204lm	2498lm	4000K

*Delivered lumens will vary depending on optic, finish and CCT*

### PRODUCT IMAGES AND DIMENSIONS

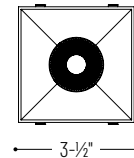
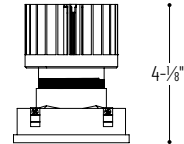

**NIO-4PSTLNDC**  
PLUS Square Trimless Reflector



**BB**  
Black  
Reflector



**BZ**  
Bronze  
Reflector

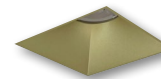

**CH**  
Champagne Haze  
Reflector



**HZ**  
Haze  
Reflector



**MPW**  
Matte Powder White  
Reflector



**WW**  
White  
Reflector

### 4" Iolite PLUS Square Trimless Reflector - New Construction Housing & Trimless Mud Ring Required

Reflector Type	Color Temperature	Finish	Lumens / Wattage
<b>NIO-4PSTLNDC</b> = PLUS Square Trimless Reflector	<b>27X</b> = 2700K	<b>BB</b> = Black	<b>/HL</b> = 1500lm to 2500lm (varies by housing)
	<b>30X</b> = 3000K	<b>BZ</b> = Bronze	
	<b>35X</b> = 3500K	<b>CH</b> = Champagne Haze	
	<b>40X</b> = 4000K	<b>HZ</b> = Haze	
	<b>50X</b> = 5000K	<b>MPW</b> = Matte Powder White	
		<b>WW</b> = White	

### Compatible Housings

Housing Type
<b>NHIOICD-4PS15</b> = ICAT New Construction / 1500lm / 20W
<b>NHIOICDCP-4PS15</b> = Chicago Plenum / 1500lm / 20W
<b>NHIOICD-4PS20</b> = ICAT New Construction / 2000lm / 24W
<b>NHIOICDCP-4PS20</b> = Chicago Plenum / 2000lm / 24W
<b>NHIOICD-4PS25</b> = ICAT New Construction / 2500lm / 28W
<b>NHIOICDCP-4PS25</b> = Chicago Plenum / 2500lm / 28W

### 4" PLUS Trimless Mud Ring

Description
<b>NIO-TLMR-4PS</b> = 4" PLUS Square Trimless Mud Ring

Example: **NIO-4PSTLNDC27XWW/HL & NIO-TLMR-4PS** = 4" Iolite PLUS Square Trimless Reflector, 2700K, White finish / 4" PLUS Square Trimless Mud Ring

# Iolite PLUS Accessories

## 4" Iolite PLUS Square Trimless Reflector

Type	
Project	
Catalog No.	
Notes	

### ACCESSORIES

Iolite accessories can be added at any point in the design process. Accessories easily install between LED module and die-cast trim. Luminaire will accommodate (1) hex lower and (1) collar accessory, no accessory holder required.

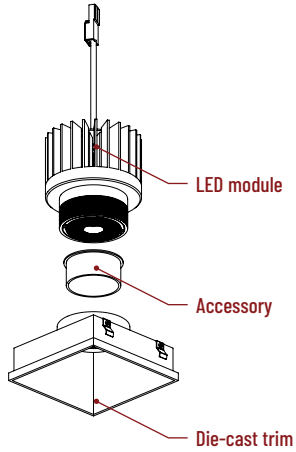

Translucent Decorative Collar

**NIO-AS14(color)** 5/8" length  
**NIO-AS19(color)** 3/4" length  
**NIO-AS26(color)** 1" length  
**Color:**  
**AM** (amber), **BLU** (blue), **FR** (frosted), **R** (red)

Translucent collars color the aperture with the specified color while producing white general light. Collars are available in different lengths. Use to add interest, create a theme, match a theme or define a space.



Opaque Collar Snoot

**NIO-AS14(color)** 5/8" length  
**NIO-AS19(color)** 3/4" length  
**NIO-AS26(color)** 1" length  
**Color:**  
**MPW** (matte powder white), **WH** (white)

Opaque snoot greatly reduces aperture brightness while preserving light output.

### TRIMLESS

4" Iolite PLUS trimless downlights have no exposed flange and the result is a minimalist knife edge appearance. A trimless mud ring is installed after the drywall and a professional drywall finisher floats the ceiling to blend in the mud ring.

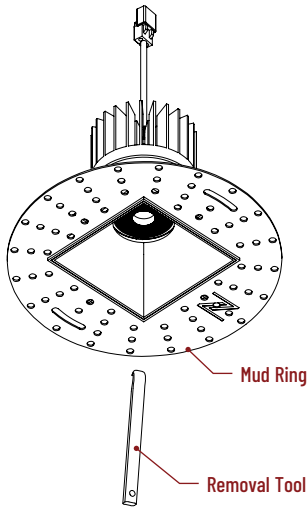

Iolite PLUS Trimless Mud Ring

**NIO-TLMR-4PS** Square Mud Ring

Mounts trimless downlight with no exposed flange and no extension beyond ceiling plane. Die-cast aluminum mud ring attaches to drywall. **Only for use with NHIOICD-4PS new construction housings and NIO-4PSTL trimless.**  
 Dimensions: 7-7/8" diameter 3/8" thick



Removal Tool

**NIO-TLTOOL**

Assist removing trimless reflector from finished ceiling after installation. For maintenance on trimless downlight. One is included with each luminaire.

# PHOTOMETRICS

4" Iolite PLUS Square Trimless Downlight  
1500 lumens

Type

Project

Catalog No.

Notes

## Test Information

Test Number: NTR1725R1  
Part Number: N10-4PSTLNDC40XMPW/HL  
Beam Spread: 40° Spot  
Lumens: 2007lm  
Wattage: 19.55W  
Efficacy: 103pw  
CCT / CRI: 4000K / 90 CRI  
Spacing Criteria (0°-180°): 0.66  
Spacing Criteria (90°-270°): 0.68

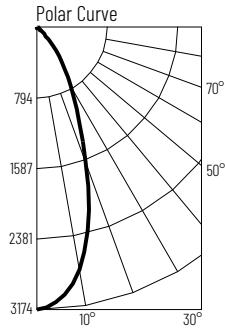

## Illuminance at a Distance

Distance from Luminaire	FC at Nadir	Beam Diameter
8'	49.6fc	5'-11"
10'	31.7fc	7'-5"
12'	22fc	8'-10"
14'	16.2fc	10'-4"
16'	12.4fc	11'-10"

## Zonal Lumen Summary

Zone	Lumens	% Luminaire
0-30	1410	70.2
0-40	1740	86.7
0-60	1967	98
0-90	1997	99.5
90-180	10	0.5
0-180	2007	100

## Candela Table

Vertical Angles	Candela
0	3174
5	3063
15	2246
25	1106
35	527
45	167

## Test Information

Test Number: NTR1727R1  
Part Number: N10-4PSTLNDC40XMPW/HL  
Beam Spread: 51° Narrow Flood  
Lumens: 2145lm  
Wattage: 19.62W  
Efficacy: 109pw  
CCT / CRI: 4000K / 90 CRI  
Spacing Criteria (0°-180°): 0.82  
Spacing Criteria (90°-270°): 0.82

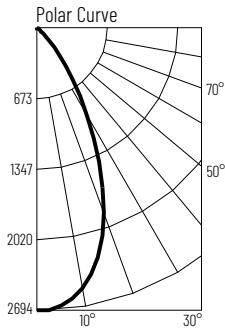

## Illuminance at a Distance

Distance from Luminaire	FC at Nadir	Beam Diameter
8'	42.1fc	7'-8"
10'	26.9fc	9'-8"
12'	18.7fc	11'-7"
14'	13.7fc	13'-6"
16'	10.5fc	15'-6"

## Zonal Lumen Summary

Zone	Lumens	% Luminaire
0-30	1510	70.4
0-40	1895	88.4
0-60	2109	98.4
0-90	2133	99.5
90-180	11	0.5
0-180	2145	100

## Candela Table

Vertical Angles	Candela
0	2694
5	2640
15	2228
25	1418
35	614
45	176

## Test Information

Test Number: NTR1729R1  
Part Number: N10-4PSTLNDC40XMPW/HL  
Beam Spread: 71° Flood  
Lumens: 1855lm  
Wattage: 19.58W  
Efficacy: 95pw  
CCT / CRI: 4000K / 90 CRI  
Spacing Criteria (0°-180°): 1.04  
Spacing Criteria (90°-270°): 1.04

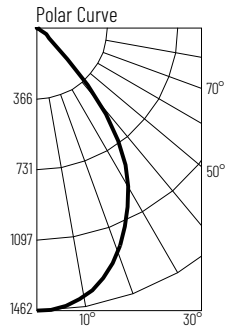

## Illuminance at a Distance

Distance from Luminaire	FC at Nadir	Beam Diameter
8'	22.8fc	11'-5"
10'	14.6fc	14'-4"
12'	10.2fc	17'-1"
14'	7.5fc	20'
16'	5.7fc	22'-11"

## Zonal Lumen Summary

Zone	Lumens	% Luminaire
0-30	1022	55.1
0-40	1456	78.5
0-60	1803	97.2
0-90	1846	99.5
90-180	9	0.5
0-180	1855	100

## Candela Table

Vertical Angles	Candela
0	1462
5	1446
15	1345
25	1106
35	760
45	186

## Lumen Output Multipliers

Color Temperature: 2700K (0.83), 3000K (0.89), 3500K (1.00), 4000K (1.00), 5000K (1.06)

# PHOTOMETRICS

## 4" Iolite PLUS Square Trimless Downlight 2000 lumens

Type

Project

Catalog No.

Notes

### Test Information

Test Number: NTR1726R1  
Part Number: N10-4PSTLNDC40XMPW/HL  
Beam Spread: 40° Spot  
Lumens: 2370lm  
Wattage: 23.67W  
Efficacy: 100pw  
CCT / CRI: 4000K / 90 CRI  
Spacing Criteria (0°-180°): 0.66  
Spacing Criteria (90°-270°): 0.68

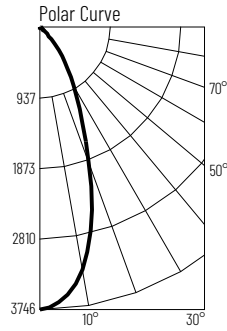

### Illuminance at a Distance

Distance from Luminaire	FC at Nadir	Beam Diameter
12'	26fc	8'-11"
14'	19.1fc	10'-4"
16'	14.6fc	11'-10"
18'	11.6fc	13'-4"
20'	9.4fc	14'-10"

### Zonal Lumen Summary

Zone	Lumens	% Luminaire
0-30	1665	70.2
0-40	2055	86.7
0-60	2323	98
0-90	2359	99.5
90-180	11	0.5
0-180	2370	100

### Candela Table

Vertical Angles	Candela
0	3746
5	3612
15	2654
25	1303
35	619
45	196

### Test Information

Test Number: NTR1728R1  
Part Number: N10-4PSTLNDC40XMPW/HL  
Beam Spread: 51° Narrow Flood  
Lumens: 2524lm  
Wattage: 23.88W  
Efficacy: 106pw  
CCT / CRI: 4000K / 90 CRI  
Spacing Criteria (0°-180°): 0.82  
Spacing Criteria (90°-270°): 0.82

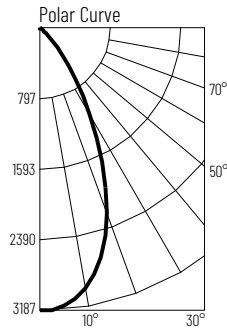

### Illuminance at a Distance

Distance from Luminaire	FC at Nadir	Beam Diameter
12'	22.1fc	11'-6"
14'	16.2fc	13'-5"
16'	12.4fc	15'-5"
18'	9.8fc	17'-4"
20'	7.9fc	19'-2"

### Zonal Lumen Summary

Zone	Lumens	% Luminaire
0-30	1782	70.6
0-40	2234	88.5
0-60	2484	98.4
0-90	2511	99.5
90-180	12	0.5
0-180	2524	100

### Candela Table

Vertical Angles	Candela
0	3178
5	3110
15	2629
25	1675
35	724
45	208

### Test Information

Test Number: NTR1730R1  
Part Number: N10-4PSTLNDC40XMPW/HL  
Beam Spread: 71° Flood  
Lumens: 2204lm  
Wattage: 23.97W  
Efficacy: 92pw  
CCT / CRI: 4000K / 90 CRI  
Spacing Criteria (0°-180°): 1.04  
Spacing Criteria (90°-270°): 1.04

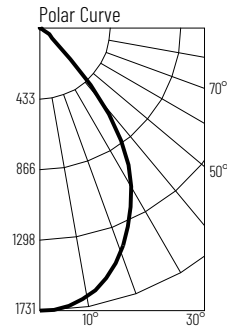

### Illuminance at a Distance

Distance from Luminaire	FC at Nadir	Beam Diameter
12'	12fc	17'-2"
14'	8.8fc	20'
16'	6.8fc	22'-11"
18'	5.3fc	25'-8"
20'	4.3fc	28'-7"

### Zonal Lumen Summary

Zone	Lumens	% Luminaire
0-30	1211	55
0-40	1649	74.8
0-60	2142	97.2
0-90	2194	99.5
90-180	10	0.5
0-180	2204	100

### Candela Table

Vertical Angles	Candela
0	1731
5	1712
15	1592
25	1311
35	899
45	225

### Lumen Output Multipliers

Color Temperature: 2700K (0.83), 3000K (0.89), 3500K (1.00), 4000K (1.00), 5000K (1.06)

# PHOTOMETRICS

## 4" Iolite PLUS Square Trimless Downlight 2500 lumens

Type

Project

Catalog No.

Notes

### Test Information

Test Number: NTR1794R1  
Part Number: N10-4PSTLNDC40XMPW/HL  
Beam Spread: 40° Spot  
Lumens: 2728lm  
Wattage: 28.16W  
Efficacy: 97pw  
CCT / CRI: 4000K / 90 CRI  
Spacing Criteria (0°-180°): 0.66  
Spacing Criteria (90°-270°): 0.68

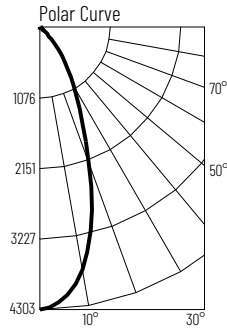

### Illuminance at a Distance

Distance from Luminaire	FC at Nadir	Beam Diameter
16'	16.8fc	11'-10"
18'	13.3fc	13'-4"
20'	10.8fc	14'-10"
22'	8.9fc	16'-4"
24'	7.5fc	17'-8"

### Zonal Lumen Summary

Zone	Lumens	% Luminaire
0-30	1914	70.2
0-40	2364	86.7
0-60	2672	98
0-90	2715	99.5
90-180	13	0.5
0-180	2728	100

### Candela Table

Vertical Angles	Candela
0	4303
5	4148
15	3049
25	1499
35	713
45	227

### Test Information

Test Number: NTR1795R1  
Part Number: N10-4PSTLNDC40XMPW/HL  
Beam Spread: 51° Narrow Flood  
Lumens: 2880lm  
Wattage: 28.18W  
Efficacy: 102pw  
CCT / CRI: 4000K / 90 CRI  
Spacing Criteria (0°-180°): 0.82  
Spacing Criteria (90°-270°): 0.82

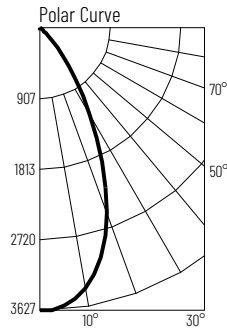

### Illuminance at a Distance

Distance from Luminaire	FC at Nadir	Beam Diameter
16'	14.2fc	15'-5"
18'	11.2fc	17'-4"
20'	9.1fc	19'-2"
22'	7.5fc	21'-1"
24'	6.3fc	23'

### Zonal Lumen Summary

Zone	Lumens	% Luminaire
0-30	2031	70.5
0-40	2547	88.4
0-60	2832	98.4
0-90	2865	99.5
90-180	15	0.5
0-180	2880	100

### Candela Table

Vertical Angles	Candela
0	3623
5	3549
15	2996
25	1906
35	821
45	236

### Test Information

Test Number: NTR1796R1  
Part Number: N10-4PSTLNDC40XMPW/HL  
Beam Spread: 71° Flood  
Lumens: 2498lm  
Wattage: 28.09W  
Efficacy: 89pw  
CCT / CRI: 4000K / 90 CRI  
Spacing Criteria (0°-180°): 1.04  
Spacing Criteria (90°-270°): 1.04

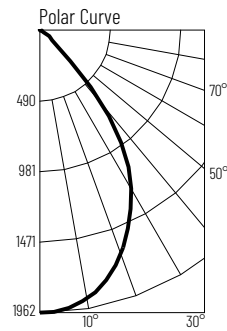

### Illuminance at a Distance

Distance from Luminaire	FC at Nadir	Beam Diameter
16'	7.7fc	22'-11"
18'	6.1fc	25'-10"
20'	4.9fc	28'-8"
22'	4.1fc	31'-6"
24'	3.4fc	34'-5"

### Zonal Lumen Summary

Zone	Lumens	% Luminaire
0-30	1372	54.9
0-40	1954	78.2
0-60	2428	97.2
0-90	2486	99.5
90-180	12	0.5
0-180	2498	100

### Candela Table

Vertical Angles	Candela
0	1961
5	1943
15	1811
25	1488
35	1023
45	289

### Lumen Output Multipliers

Color Temperature: 2700K (0.83), 3000K (0.89), 3500K (1.00), 4000K (1.00), 5000K (1.06)