

# Installation Instructions

## NHIOICD-28 / NHIOICD-48

### Iolite New Construction Housing

**READ PRIOR TO ATTEMPTING INSTALLATION**  
**ALWAYS TURN OFF MAIN POWER BEFORE INSTALLATION**  
**INSTALLATION SHOULD BE CARRIED OUT BY YOUR LOCAL ELECTRICIAN**

Fixtures are listed for insulated ceilings—Type IC, airtight—AT and for suspended ceilings—Type S. To insure safe and reliable operations, make sure the fixture corresponds to the proper ceiling installation. Read the following material carefully before beginning installation. In general these instructions apply to “round” housings. Drawings of “round” housings have been used to illustrate installation procedures.

Before attempting installation of any recessed lighting fixture check your local electrical code. This code sets the wiring standards for your locality and should be carefully studied before starting work.

#### INSULATED CEILINGS - TYPE IC

##### Insulated Ceiling

The insulated ceiling or IC approved recessed fixture is one that can be installed in direct contact with insulation.

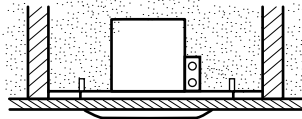

#### SUSPENDED CEILINGS - TYPE S

Fixture can be installed in suspended ceilings that are not permanent or insulated.



#### AIRTIGHT INSTALLATION

Nora housings certified under ASTM E283 are supplied with a pre-installed gasket or supplied with a ready-to-install self adhesive gasket.

- Step 1. Lay gasket flat and peel protective paper backing from gasket to expose adhesive side.
- Step 2. Apply supplied gasket to ceiling lip and wrap gasket around inside of housing to form seal of the ceiling opening or apply caulk per state/local code. When properly installed, Nora housings provide compliance with restricted air-flow regulations.

#### FIRE/ELECTRICAL HAZARD: INSTALL ACCORDING TO NATIONAL ELECTRIC CODE AND ANY APPLICABLE MUNICIPAL CODE REQUIREMENTS.

This equipment is intended to be installed only by qualified personnel. The installation must be made in accordance with the current edition to the National Electric Code and all applicable state and local building codes. The final installation must be approved by the appropriate qualified electrical/building inspector(s). Improper installation may result in a fire or electrical hazard. Be sure the electrical power to the circuit has been disconnected before installing this electrical system.

For additional details, contact technical support at 800.686.6672.

#### FEU / RISQUE ÉLECTRIQUE: INSTALLER SELON AU CODE ÉLECTRIQUE NATIONAL ET LES EXIGENCES DE CODE MUNICIPAUX APPLICABLES.

Cet équipement est destiné à être installé par un personnel qualifié. L'installation doit être faite conformément à l'édition actuelle du Code national de l'électricité et tous les codes d'état et de construction locaux applicables. L'installation finale doit être approuvée par l'inspecteur en électricité / bâtiment qualifié approprié (s). Une mauvaise installation peut provoquer un incendie ou un risque électrique. Assurez-vous que l'alimentation électrique du circuit a été coupée avant l'installation de ce système électrique. Pour plus de détails, contactez le support technique au 800.686.6672.

#### IMPORTANT- RISK OF FIRE:

Most dwellings built before 1985 have supply wire rated 60°C (thermal cutoffs in fixtures operate at 90°C); consult a qualified electrician prior to installation. If supply wires are located within three inches of fixture, use wire rated for at least 90°C. Contact technical support at 1-800-686-6672 for additional details.

#### IMPORTANT-RISQUE D'INCENDIE:

La plupart des logements construits avant 1985 ont le fil d'alimentation nominale de 60°C (disjoncteurs thermiques dans les appareils fonctionnent à 90°C); consultez un électricien qualifié avant l'installation. Si les fils d'alimentation sont situés à moins de trois pouces de appareil, l'utilisation de fil résister au moins à 90°C. Contactez le support technique au 1-800-686-6672 pour plus de détails.

#### STANDARD “JOIST” CELING INSTALLATION:

1. Use bar hangers to attach fixture between ceiling joists. Each end of the bar hanger is equipped with a nail-in barbed tab. Additional hardware such as screws or nails may be used if extra support is necessary. **The bar hangers can be mounted at either side by unscrewing / screwing the screws.**
2. For steel studs, use steel piercing screws in place of nails or barbed tabs.
3. Remove shipping screw from underneath side of plaster frame.

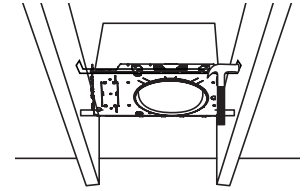

#### T-BAR CELING INSTALLATION:

1. If mounting to a T-Bar type ceiling, mount fixture onto grid by placing notches on the bottom of each end of the bar hanger over the grid.
2. Tie fixture to grid with structural wire going through both the circular knockout on the end of the bar hanger and nearest accompanying knockout on the ceiling grid.

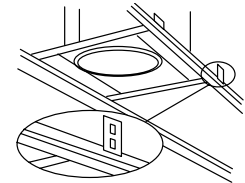

**NOTE:** It is imperative to tie down the fixture to prevent the fixture from being pushed above the ceiling during reflector installation.

#### CUTTING A HOLE:

1. Locate the center of proposed opening on your tile or ceiling and mark it.
2. Use a compass to draw a circle in diameter around the center point. See chart for cut-out dimension.
3. Cut along this circular line.

Cut-out dimension	
NHIOICD-28	3-1/4"
NHIOICD-48	4-5/16"

#### WIRING DIAGRAM:

Refer to wiring diagram on page 2.

**NOTE ON GROUNDING:** Many structures carry grounding via steel conduit. If this is the case, if there is no grounding wire, simply leave green wire on fixture unattached. Fixture will be grounded through attachment of conduit to junction box. However, if Romex or PVC conduit is used, ground wire will always be present, and must be connected to green wire on fixture junction box to avoid electrical shock hazard.

#### DRIVER REPLACEMENT:

1. Turn off power.
2. Pull the trim down from the opening.
3. Disconnect the orange connector.
4. The driver can be removed by sliding it out from the snap-in bracket.
5. Remove driver from mounting bracket and replace with new driver.
6. Re-install driver/mounting bracket
7. Reconnect power wires.
8. Reconnect fixture into place.
9. Turn on fixture and make sure all connections are secure.

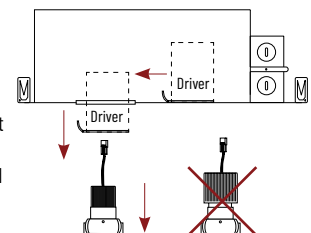

**NOTE ON LED MODULE:**  
**DO NOT USE WITH NIO-LEDHL SERIES,**  
**USE ONLY WITH NIO-LED89 OR NIO-LED109.**

# Installation Instructions

## NHIOICD-28 / NHIOICD-48

### Iolite New Construction Housing

READ PRIOR TO ATTEMPTING INSTALLATION  
 ALWAYS TURN OFF MAIN POWER BEFORE INSTALLATION  
 INSTALLATION SHOULD BE CARRIED OUT BY YOUR LOCAL ELECTRICIAN

#### ELECTRICAL CONNECTIONS:

1. Connect ½ inch trade size steel conduit to junction box with appropriate fitting. If using Romex-type shielded wiring, use rectangular pry-out strain reliefs located on upper corners of junction box.
2. Connect wires accordingly:
  - Black (120/277V) = Supply Voltage
  - White = Neutral
  - Green or Copper Wire = Grounding Junction Box Wire
 0-10V Wiring:
  - Purple = Dim (+)
  - Pink or Grey = Dim (-)
 (Maximum of 8 no. 12 AWG through branch circuit conductors suitable for at least 90°C permitted in junction box. AC ONLY)

**NOTE ON GROUNDING:** Many structures carry grounding via steel conduit. If this is the case, if there is no grounding wire, simply leave green wire on fixture unattached. Fixture will be grounded through attachment of conduit to junction box. However, if Romex or PVC conduit is used, ground wire will always be present, and must be connected to green wire on fixture junction box to avoid electrical shock hazard.

#### 120/277V CONNECTION:

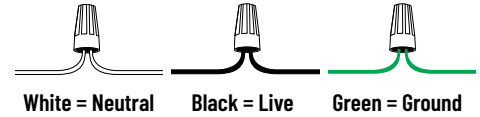

#### 0-10V DIMMING CONNECTION:

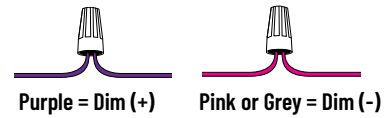

\* cap off 0-10V wires if dimming wires are not used \*

#### WIRING DIAGRAM (0-10V DIMMING)

LE4: Triac, ELV or 0-10V

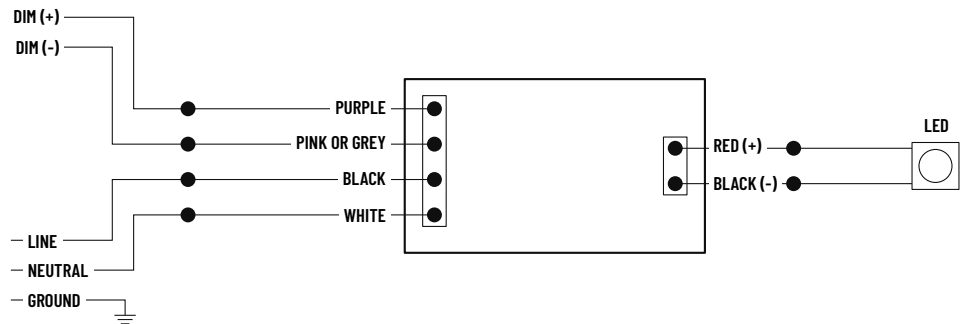

#### WIRING DIAGRAM (LUTRON ECOSYSTEM)

LUPE0: Lutron Hi-Lume Premier 0.1% EcoSystem  
 LUPE1: Lutron Hi-Lume 1% EcoSystem

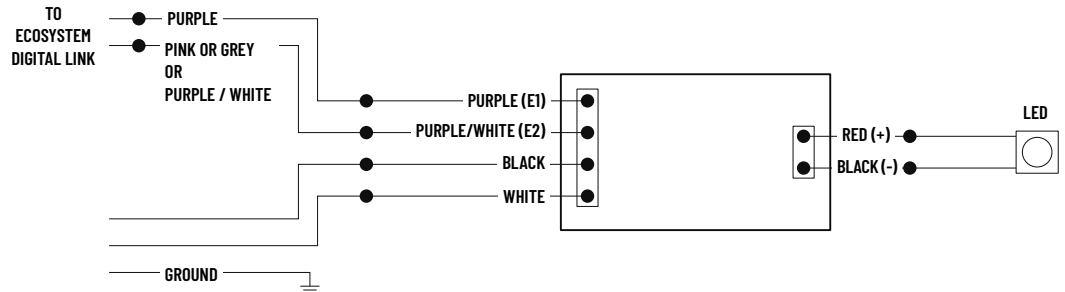

# Installation Instructions

## NHIOICD-28 / NHIOICD-48

### Iolite New Construction Housing

READ PRIOR TO ATTEMPTING INSTALLATION  
 ALWAYS TURN OFF MAIN POWER BEFORE INSTALLATION  
 INSTALLATION SHOULD BE CARRIED OUT BY YOUR LOCAL ELECTRICIAN

#### EMERGENCY CONNECTION (NEPK-07LEDUNV)

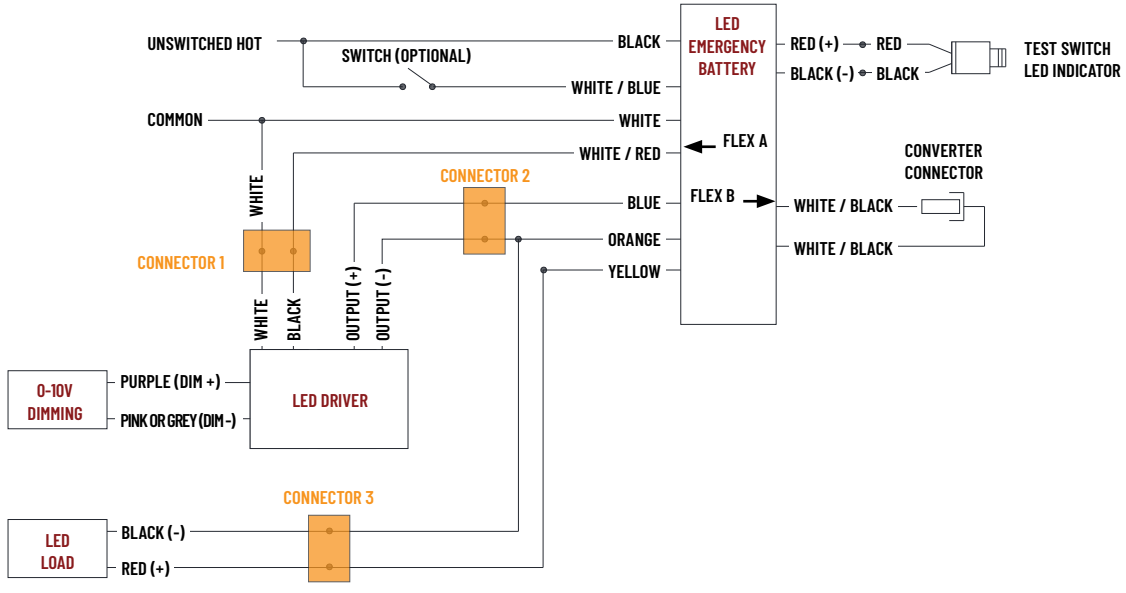

#### CONNECTOR 1

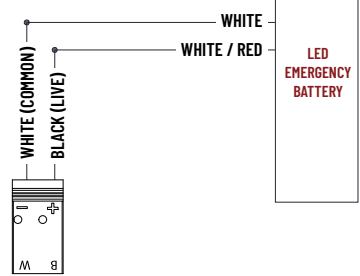

Connector 1  
TO DRIVER INPUT

#### CONNECTOR 2

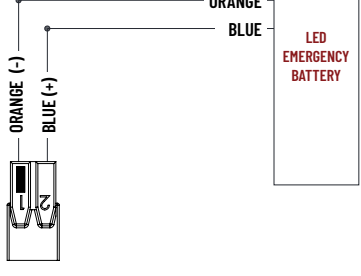

Connector 2  
TO DRIVER OUTPUT

#### CONNECTOR 3

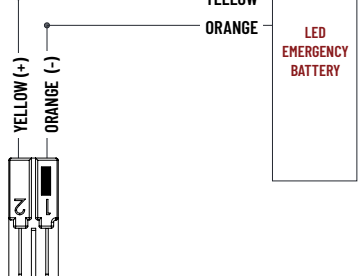

Connector 3  
TO LED LOAD INPUT

# Installation Instructions

## NHIOICD-28 / NHIOICD-48

### lolite New Construction Housing

READ PRIOR TO ATTEMPTING INSTALLATION  
 ALWAYS TURN OFF MAIN POWER BEFORE INSTALLATION  
 INSTALLATION SHOULD BE CARRIED OUT BY YOUR LOCAL ELECTRICIAN

#### EMERGENCY CONNECTION WITH LUTRON ECO-SYSTEM (NEPK-07LEDUNV)

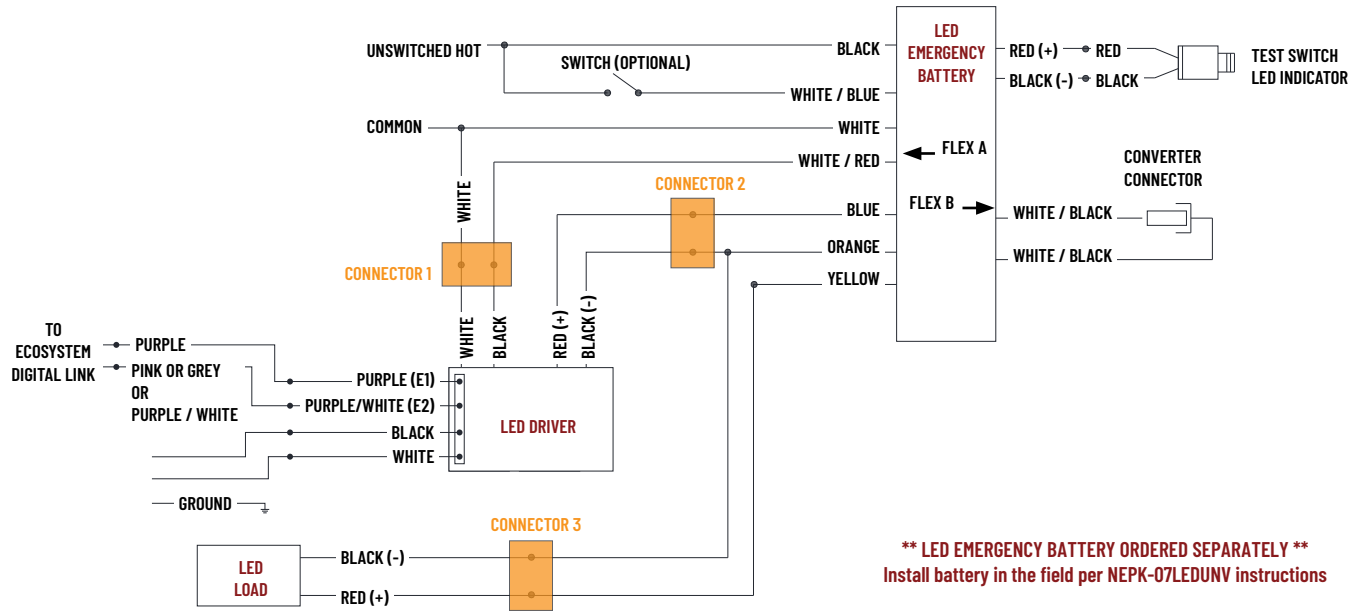

**\*\* LED EMERGENCY BATTERY ORDERED SEPARATELY \*\***  
 Install battery in the field per NEPK-07LEDUNV instructions

#### CONNECTOR 1

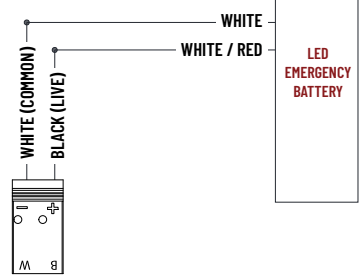

Connector 1  
TO DRIVER INPUT

#### CONNECTOR 2

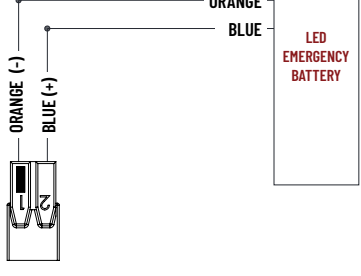

Connector 2  
TO DRIVER OUTPUT

#### CONNECTOR 3

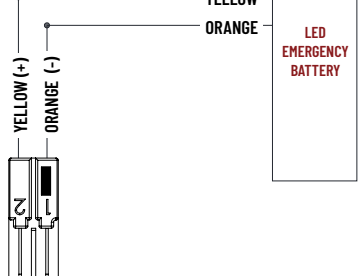

Connector 3  
TO LED LOAD INPUT

# Installation Instructions

## NHIOICD-28 / NHIOICD-48

### Iolite New Construction Housing

READ PRIOR TO ATTEMPTING INSTALLATION  
 ALWAYS TURN OFF MAIN POWER BEFORE INSTALLATION  
 INSTALLATION SHOULD BE CARRIED OUT BY YOUR LOCAL ELECTRICIAN

#### EMERGENCY CONNECTION (/EM2)

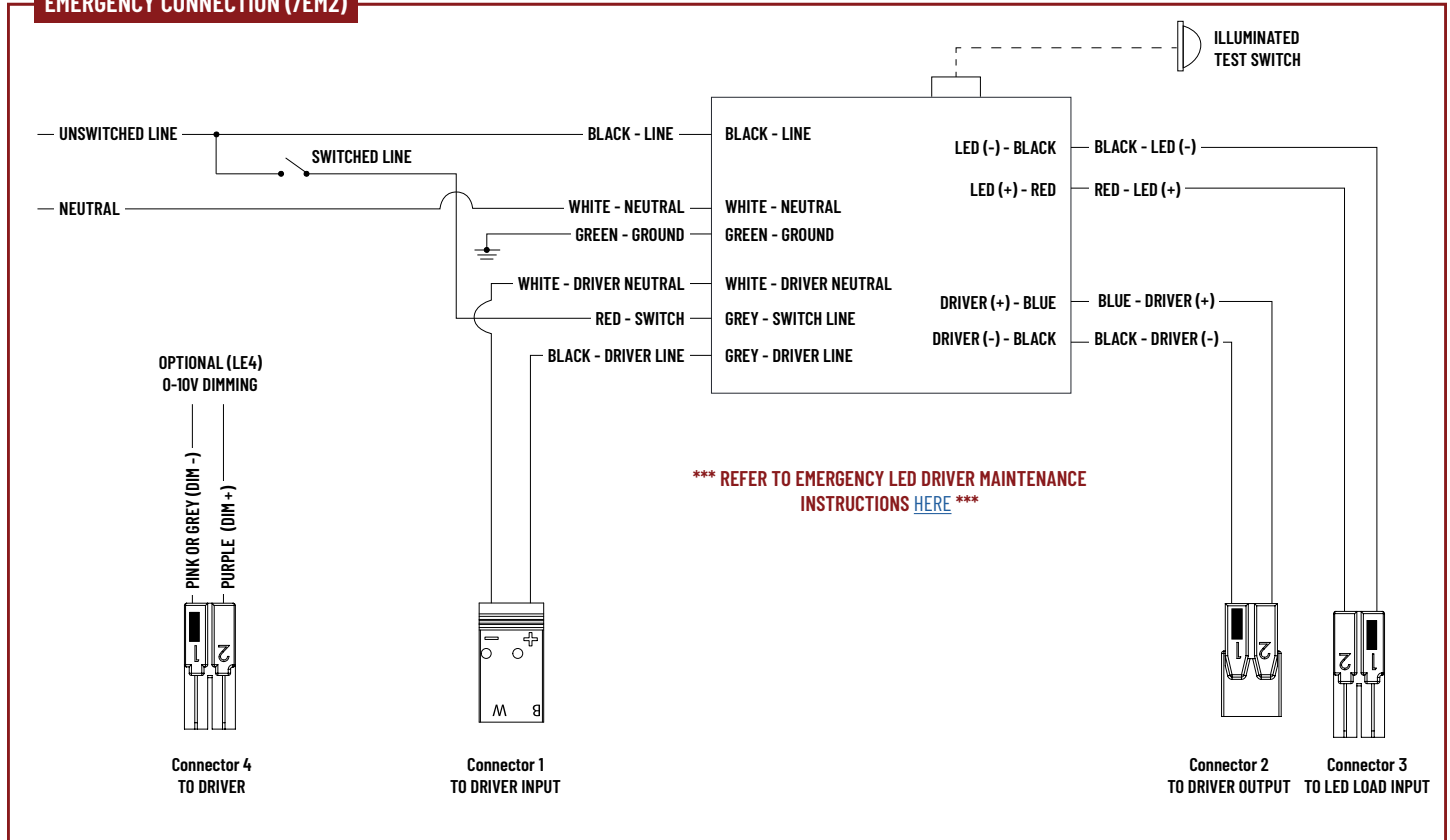

#### CONNECTOR 1

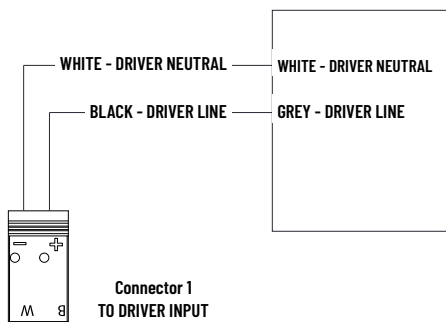

#### CONNECTOR 2

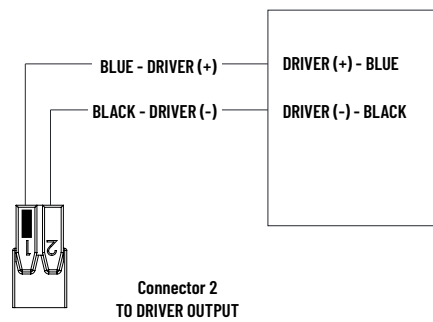

#### CONNECTOR 3

