

The elegant thin-profile TapSwitch™ dimmer.

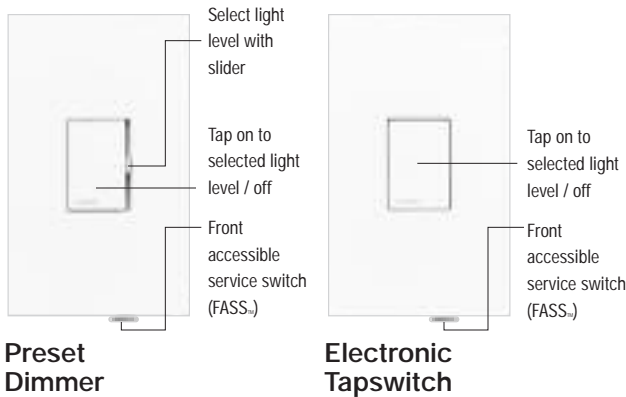

PRODUCT FAMILY FEATURES

- Sophisticated thin-profile styling featuring a large tapswitch and discrete linear slider
- Perfect solution for high-end applications
- Elegant appearance and operation
- Enclosed heat sink for an aesthetically pleasing appearance
- Multigang alignment for quick and easy installation
- Full line of matching devices and accessories
- Simple selection – all dimmers operate as single pole or 3-way

DIMENSIONS

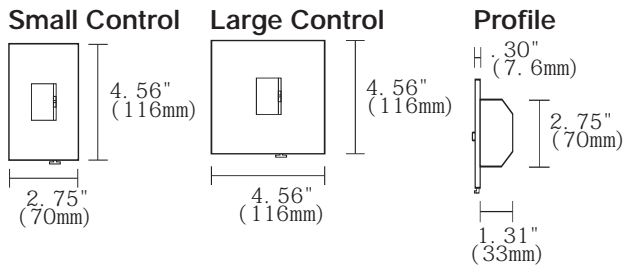

SPECIFICATION SERIES STANDARD FEATURES



- Square Law Dimming
- Power-failure memory
- Captive tapswitch and linear slider
- Front accessible service switch (FASS.)
- Heavy-duty components for surge protection and long product life
- Voltage compensation
- Superior RFI suppression
- Precise color matching
- Electrostatic discharge tested

Lutron controls are rated at 120VAC, 60Hz unless otherwise noted.

JOB NAME	AREA CONTROLLED
LOCATION	JOB NUMBER
TITLE	PAGE NO.

CONTROLS AND ACCESSORIES

Preset Dimmers

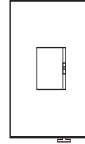

Electronic Tapswitches

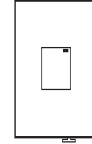
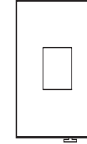

(with status light)

Fan-Speed Controls

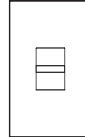

(Small Control)

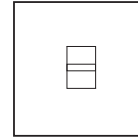

(Large Control)

Auxiliary Tapswitches

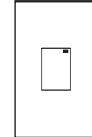
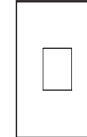

(with status light)

Receptacles

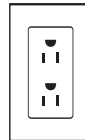

15A Receptacles

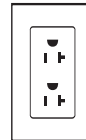

20A



15A GFCI Receptacles



20A

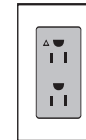

15A

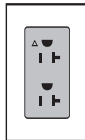

20A Isolated Ground Receptacles

Telephone/Cable TV Jacks

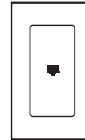

Single Telephone Jack

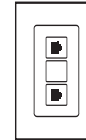

Double

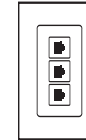

Triple

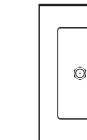

Cable TV Jack

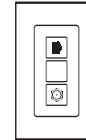

Telephone/Cable TV Jack

Ports

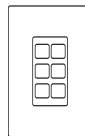

6-Port Frame

Custom Multigang Wallplates

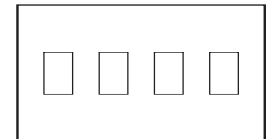
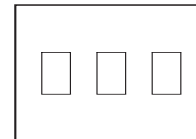
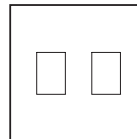

2-gang, 3-gang and 4-gang for dimmers/switches

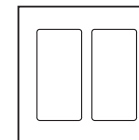
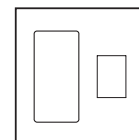
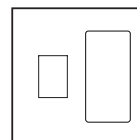

2-gang for a dimmer or switch and a receptacle or jack

Description	Maximum Capacity ¹	Model #
-------------	-------------------------------	---------

DIMMERS



Incandescent/Magnetic Low Voltage



Preset Dimmers

SMALL CONTROL

Single pole/multi-location 600W/VA V-600-
Single pole/multi-location 1000W/VA V-1000-

Note: For multi-location switching, use with VETS-R-.
Not for use with mechanical 3-way or 4-way switches.



Fluorescent Dimming with Hi-lume® and Eco-10™ (ECO-Series) Electronic Ballasts



Preset Dimmers

SMALL CONTROL

Single pole/multi-location
20 ballasts / 8A VF-10-

Note: For use with line-voltage control electronic dimming ballasts only. Requires neutral wire connection. For multi-location switching, use with VETS-R-. Not for use with mechanical 3-way or 4-way switches.

HI-POWER 2•4•6™ DIMMING MODULES

To increase load capacity up to 30,000W/VA in most popular sources, use one V-600- and add up to five dimming modules. Cannot be used with 0-10VDC ballast.

TAPSWITCHES

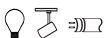

Incandescent/Magnetic Low Voltage/Fluorescent Switching with Magnetic Ballasts



Electronic Tapswitch

SMALL CONTROL

Single pole/multi-location 1000W/VA VETS-1000-

Note: For multi-location switching, use with VETS-R-. Not for use with mechanical 3-way or 4-way switches. Do not use on shunt power factor corrected magnetic ballasts.



Electronic Tapswitch with Status Light

SMALL CONTROL

Single pole/multi-location 1000W/VA VETS-1000-SL-
Auxiliary Electronic Tapswitch ² VETS-A-SL-

Note: Use up to four VETS-A-SL- with only one VETS-1000-SL- for multi-location switching. Not for use with mechanical 3-way or 4-way switches. Do not use on shunt power factor corrected magnetic ballasts. Requires neutral wire connection.



Electronic Low Voltage/Fluorescent Switching with Electronic Ballasts



Electronic Tapswitch

SMALL CONTROL

Single pole/multi-location 1000W/VA VETN-1000-

Note: For multi-location switching, use with VETS-R-. Not for use with mechanical 3-way or 4-way switches.

Description	Maximum Capacity ¹	Model #
-------------	-------------------------------	---------

AUXILIARY ELECTRONIC TAPSWITCHES

Provides multi-location switching from up to nine additional locations.

Auxiliary Electronic Tapswitch ²



SMALL CONTROL

Auxiliary Electronic Tapswitch VETS-R-

Note: For multi-location switching, use up to nine auxiliary electronic tapswitches, VETS-R-, with only one of the following Vareo dimmers or switches: V-600-, V-1000-, VF-10-, VETS-1000-, VETN-1000-.

FAN-SPEED CONTROLS



Quiet Controls



For use with one ceiling paddle fan.

Slide-to-Off Fan-Speed Control ²

SMALL CONTROL

Single pole/3-speed 1.5A NTFSQ-



Fully Variable Controls

For use with one or more ceiling, ventilation, or exhaust fan. Do not mix fan types on one control.

Slide-to-Off Fan-Speed Control



SMALL CONTROL

Single pole/Adjustable Minimum Speed
6A NTFS-6E-



LARGE CONTROL

Single pole/Adjustable Minimum Speed
12A NTFS-12E-

Note: To use as a combined fan-speed control/light switch (360W incandescent), see Wiring Diagram #12.

¹ For capacities in multigang installations see derating, page 4.

² No derating required if ganged.

Description	Model #
-------------	---------

ACCESSORIES

Receptacles

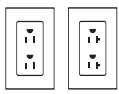

*Receptacle*¹

15A, 125V	NTR-15-
20A, 125V	NTR-20-

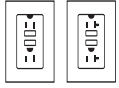

*GFCI Receptacle*¹

15A, 125V	NTR-15-GFCI-
20A, 125V	NTR-20-GFCI-

Note: The product face is permanently attached and is not a detachable insert.

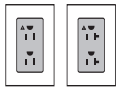

*Isolated Ground Receptacle*¹

15A, 125V	NTR-15-IG-OR-
20A, 125V	NTR-20-IG-OR-

Note: Receptacle is orange; wallplate is color selected. Receptacles can be special ordered to match wallplate color; consult Customer Service.

Telephone and Cable Television Jacks

*Telephone Jack*²



SINGLE
6-conductor, RJ11

NT-PJ-

Note: Also accepts most 4-conductor plugs.



DOUBLE³
8-conductor, RJ45, Category 5

NT-PJ8X2-

Note: Also accepts most 4- or 6-conductor plugs.



TRIPLE³
8-conductor, RJ45, Category 5

NT-PJ8X3-

Note: Also accepts most 4- or 6-conductor plugs.



*Cable TV Jack*²

SINGLE
F-style, 75-Ohm, coaxial cable

NT-CJ-



Telephone/Cable TV Jack^{2,3}

8-conductor, RJ45,
Category 5 phone jack /
F-style, 75-Ohm, coaxial cable jack

NT-PJ8CJ-

Note: Phone jack also accepts most 4- or 6- conductor plugs.

1 No derating required if ganged.

2 A physical barrier (partition) must exist when ganging with line-voltage products.

3 Wallplate and insert match specified color. Device (e.g., phone jack) and device trim are white for ivory, white, beige, and taupe products; black for gray, brown, black, metal and special metal products. See cable jack example at left, shown in ivory.

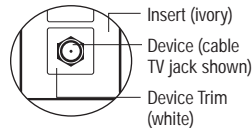

4 Vareo dimmers and Vareo tapswitches must have side sections removed to gang if using "VWP" wallplate.

Description	Rating	Model #
-------------	--------	---------

ACCESSORIES

Field Customizable Multi-Port Frame

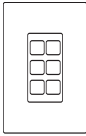







6-Port Frame	Shipped with 6 blanks <i>Shown with blanks</i>	NT-6PF-□
--------------	---	----------

Product above: For use with Lutron connectors shown below. Also compatible with Hubble Xcelerator™ and snap-fit connectors.

Connectors

For use with 6-port frame (NT-6PF-). Each connector fills one port.

	Phone Jack	6-conductor, RJ11, Category 3	CON-1P-C3-WH
	Phone Jack	8-conductor, RJ45, Category 5e	CON-1P-C5E-WH
	Phone Jack	8-conductor, RJ45, Category 6	CON-1P-C6-WH
	Fiber Jack	MT-RJ Feed-Through	CON-1F-MTRJ-WH
	Fiber Jack	SC Simplex	CON-1F-SC-WH
	Fiber Jack	LC Non-Flush Mount	CON-1F-LC-WH
	Fiber Jack	ST Style	CON-1F-ST-WH
	Cable Jack	F-Style, 75-Ohm Coaxial cable	CON-1C-WH
	BNC Jack	BNC connector	CON-1B-WH

Connectors available in white (WH) only. For information about additional colors contact Lutron Customer Service.

STANDARD MULTIGANG WALLPLATES ⁴



1-Gang

Single-gang wallplate is provided with Vareo product.



2-Gang

FOR TWO DIMMERS OR SWITCHES

4.56"W (116mm) x 4.56"H (116mm) x 0.30"D (7.6mm)
VWP-2-



FOR TWO RECEPTACLES OR JACKS

4.56"W (116mm) x 4.56"H (116mm) x 0.30"D (7.6mm)
VWP-2R-



FOR ONE DIMMER OR SWITCH AND ONE RECEPTACLE OR JACK

4.56"W (116mm) x 4.56"H (116mm) x 0.30"D (7.6mm)
VWP-2CR-



FOR ONE RECEPTACLE OR JACK AND ONE DIMMER OR SWITCH

4.56"W (116mm) x 4.56"H (116mm) x 0.30"D (7.6mm)
VWP-2RC-

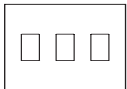

3-Gang

FOR THREE DIMMERS OR SWITCHES

6.32"W (161mm) x 4.56"H (116mm) x 0.30"D (7.6mm)
VWP-3-



4-Gang

FOR FOUR DIMMERS OR SWITCHES

8.45"W (215mm) x 4.56"H (116mm) x 0.30"D (7.6mm)
VWP-4-

STANDARD COLORS/FINISHES

Matte Finishes (Ships in 3-5 days)

Add color/finish suffix to model number to order.

Example: V-600-**WH**

WH	White
BE	Beige
IV	Ivory
GR	Gray
BR	Brown
BL	Black
TP	Taupe

SPECIAL ORDER MULTIGANG AND METAL WALLPLATES

Multigang and metal wallplates are available. When ordering product for use with metal wallplates, the product and wallplate must be ordered separately. See the Nova Ta /Nova Wallplate Ordering Guide in the Lutron Residential Lighting Controls Catalog (360-975) for ordering procedure.

See below for complete list of metal finishes.

Metal Finishes (Ships in 4-6 weeks)

SB	Satin Brass
BB	Bright Brass
BC	Bright Chrome

Special Metal Finishes

QB	Antique Brass
QZ	Antique Bronze
SC	Satin Chrome
SN	Satin Nickel
BN	Bright Nickel

Anodized Aluminum Finishes

CLA	Clear Anodized Aluminum
BLA	Black Anodized Aluminum
BRA	Brass Anodized Aluminum

DERATING/MAXIMUM CAPACITY ¹



No side sections removed
(Full Capacity)



One side section removed
(End Units)

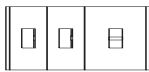

Two side sections removed
(Middle Unit)

Incandescent Dimmers

600W	500W	300W
1000W	900W	700W

Magnetic Low Voltage Dimmers

600VA (450W ¹)	500VA (400W ¹)	300VA (250W ¹)
1000VA (800W ¹)	900VA (750W ¹)	700VA (500W ¹)

Fluorescent Dimmers ²

20 ballasts / 8A	20 ballasts / 6A	20 ballasts / 4.5A
------------------	------------------	--------------------

Electronic Tapswitches

VETS-1000-	1000W/VA	900W/VA	700W/VA
VETS-1000-SL-	1000W/VA	900W/VA	700W/VA
VETN-1000-	1000W/VA	700W/VA	550W/VA

Quiet Fan-Speed Controls

1.5A	No Derating Required
------	----------------------

Fully Variable Fan-Speed Controls

6A	4.2A	2.5A
12A	10A	8.3A

¹ Actual lamp wattage.

² For use with Lutron® Hi-lume® FDB and Eco-10™ electronic dimming ballasts only.

WIRING DIAGRAMS

Wiring Diagram 1 Single-Pole Wiring

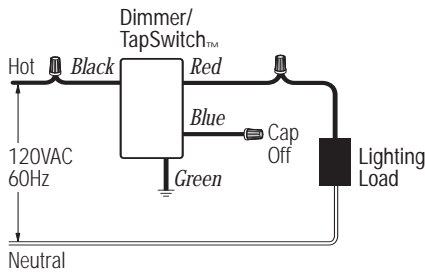

- Ground
- Wire Connectors

Model #

V-600-
V-1000-
VETS-1000-

Wiring Diagram 2 Multi-Location Wiring

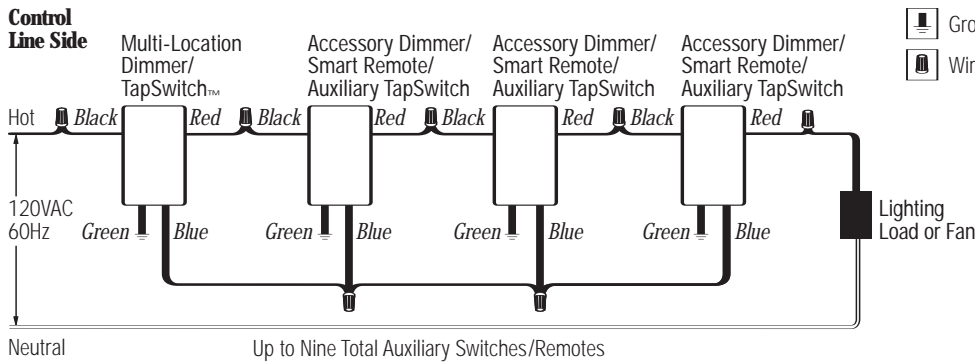

- Ground
- Wire Connectors

Model #

V-600-
V-1000-
VETS-R-
VETS-1000-

Wiring Diagram 3 Multi-Location Wiring

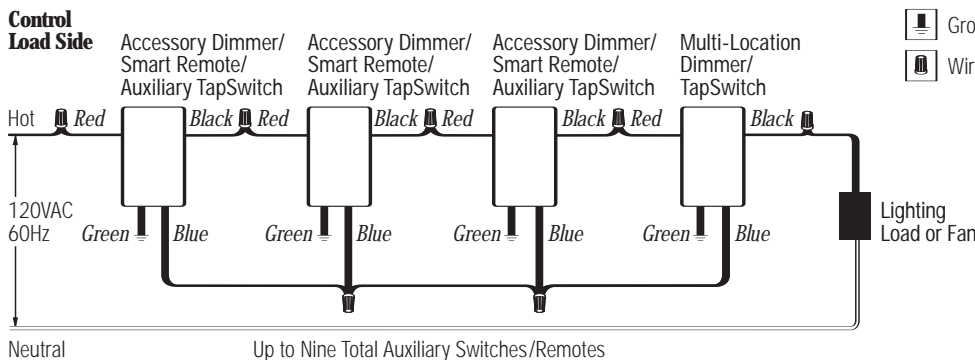

- Ground
- Wire Connectors

Model #

V-600-
V-1000-
VETS-R-
VETS-1000-

WIRING DIAGRAMS

Wiring Diagram 4
Multi-Location Wiring

Model #

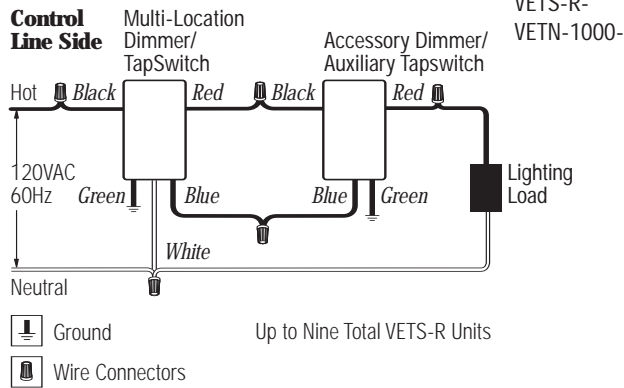

Wiring Diagram 7
Multi-Location Wiring

Model #

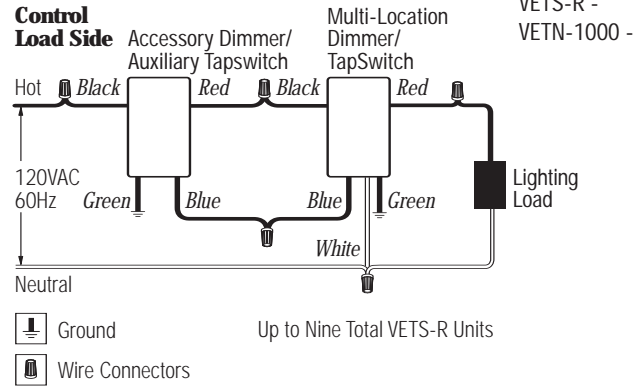

Wiring Diagram 5
Multi-Location Control with Neutral
Used for Single-Location Wiring

Model #

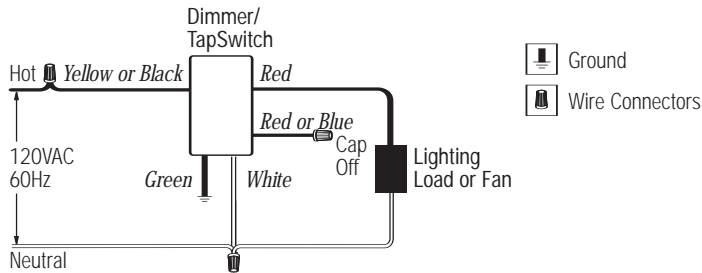

Wiring Diagram 6
Multi-Location Wiring

Model #

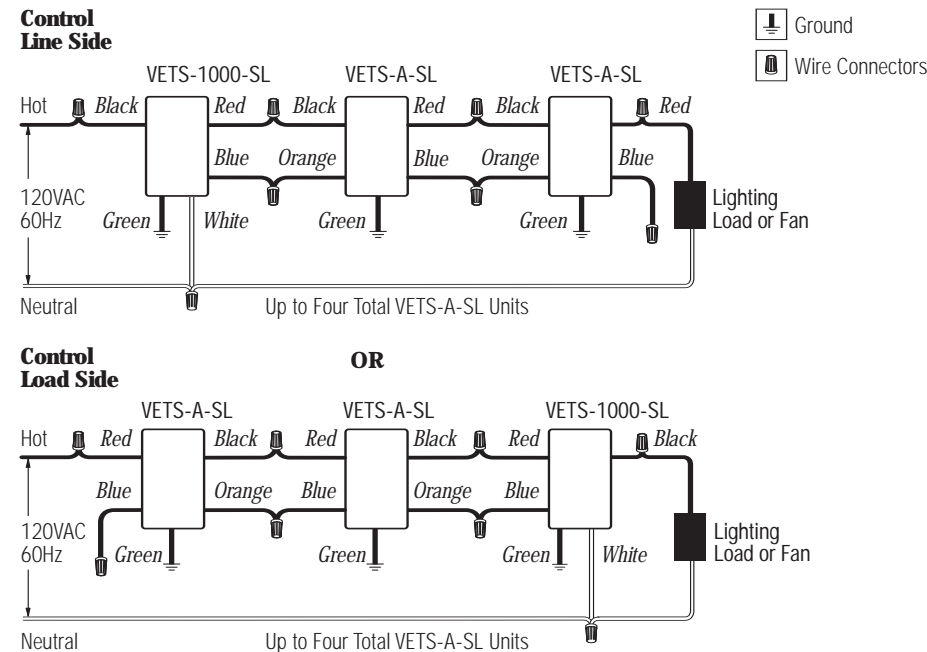

WIRING DIAGRAMS

Wiring Diagram 8
Multi-Location Wiring

Model #

VF-10-

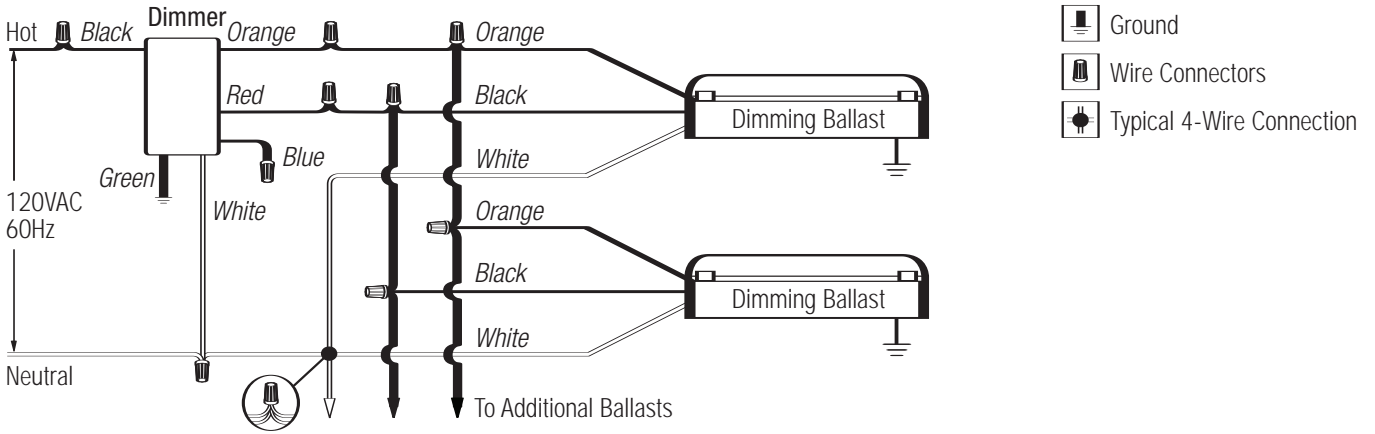

Wiring Diagram 9
Multi-Location Wiring (Control must be wired on load side)

Model #

VF-10-
VETS-R-

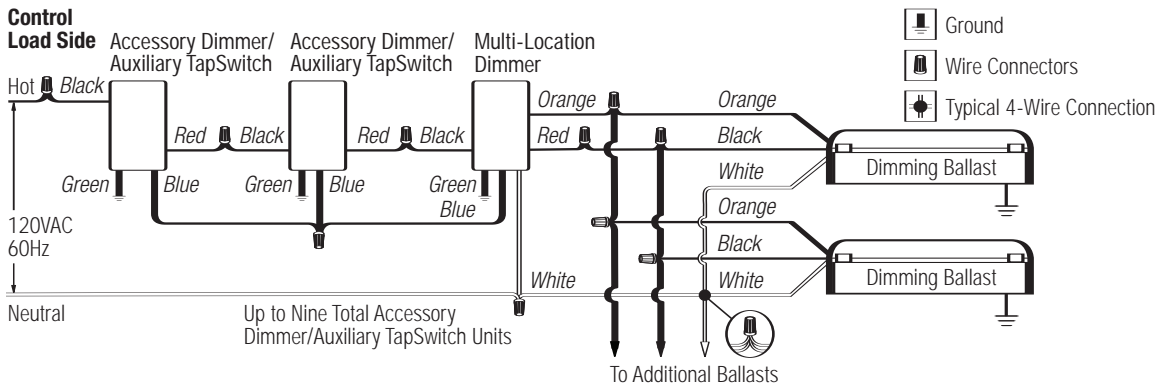

WIRING DIAGRAMS

Wiring Diagram 10
Single-Pole Wiring

Model #

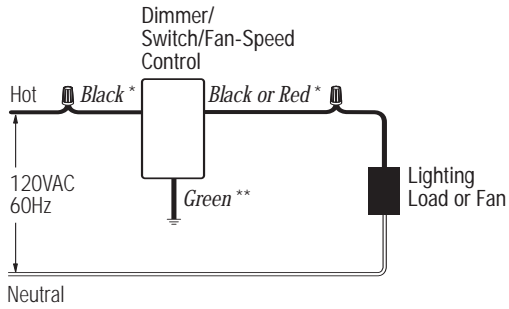

NTFSQ-

Ground

Wire Connectors

* or Brass screw terminal
** or Green screw terminal

Wiring Diagram 12
Single-Pole Wiring, Fan/Light

Model #

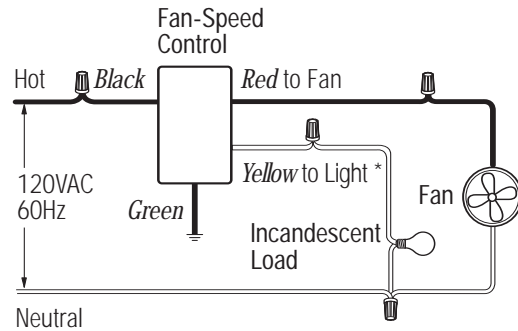

NTFS-6E-
NTFS-12E-

Ground

Wire Connectors

* Switched full voltage only

Wiring Diagram 11
Single-Pole Wiring, Fan Only

Model #

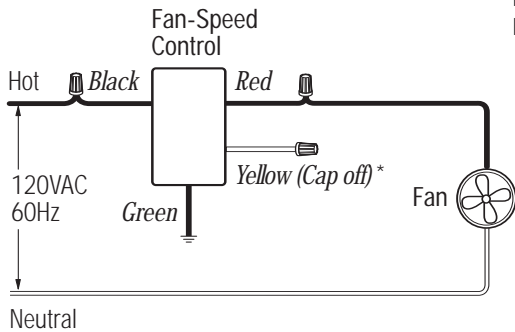

NTFS-6E-
NTFS-12E-

Ground

Wire Connectors

* Switched full voltage only

WIRING DIAGRAMS

Wiring Diagram 13
Cable TV Jack Wiring

Model #

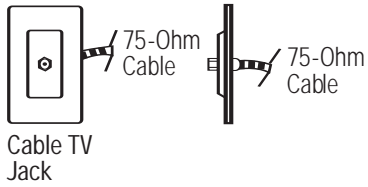

NT-CJ-
NT-PJ8CJ-

Wiring Diagram 16
Receptacle Wiring

Model #

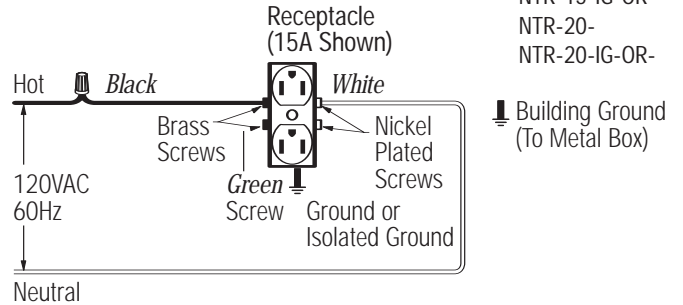

NTR-15-
NTR-15-IG-OR-
NTR-20-
NTR-20-IG-OR-

Wiring Diagram 14
Telephone Jack Wiring

Model #

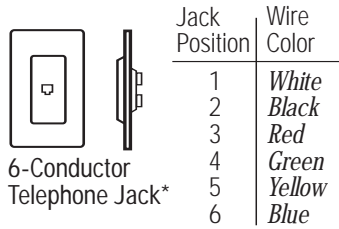

NT-PJ-

*accepts most 4-conductor jacks

Wiring Diagram 17
GFCI Receptacle Wiring

Model #

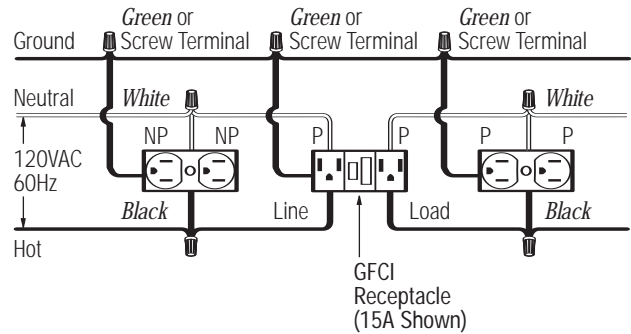

NTF-10-
NTF-10-277-

Wiring Diagram 15
Telephone Jack Wiring

Model #

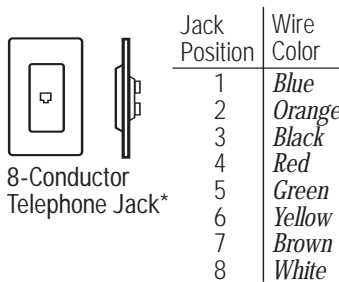

NT-PJ8CJ-
NT-PJ8X2-
NT-PJ8X3-

*accepts most 4- or 6-conductor jacks

P-Protected
NP-Not Protected

Wire Connectors

VAREO CONTROLS AND ACCESSORIES

PART 1 – GENERAL

1.01 SUMMARY

- A. Scope: Provide, install and test all switches, dimmers and related devices as specified herein for the areas indicated on the drawings, specifications, and load schedules.
- B. Related Sections: Section 16580 (Ballasts), Section 16570 (Dimming Systems).

1.02 REFERENCES

- A. UL 20, UL 1472, CSA, NOM, ISO 9001

1.03 SYSTEM DESCRIPTION AND OPERATION

- A. Permanently installed, wallbox mounted switches and dimmers
- B. Permanently installed, wallbox mounted fan-speed controls
- C. Permanently installed, wallbox mounted receptacles
- D. Permanently installed, wallbox mounted data, voice and cable jacks
- E. Screwless, seamless wallplates

1.04 SUBMITTALS

- A. Submit manufacturer's standard catalog data giving all application, wiring, and installation information on basic components and wallplate kits. Provide test data and/or samples as required to demonstrate conformance with PART 2 of this specification.

1.05 QUALITY ASSURANCE

- A. Manufacturer shall have a minimum of 10 years continuous experience in manufacturing wallbox dimming products.
- B. Dimmers, switches and Fan-speed controls shall be UL listed, CSA and NOM approved specifically for each required load (i.e., tungsten, electronic low voltage transformer, magnetic low voltage transformer, and fluorescent). Manufacturer shall provide file card or certificate upon request. Universal load-type dimmers shall not be acceptable.
- C. Manufacturer shall maintain ISO 9001 certification and provide a copy of the certificate upon request.

1.06 WARRANTY

- A. All devices shall be covered by a minimum one-year warranty.

PART 2 – EQUIPMENT

2.01 ACCEPTABLE MANUFACTURERS

- A. Lutron Electronics Co., Inc.
- B. Unless otherwise noted, all basic components (dimmer, fan-speed control, switch, receptacle, telephone jack and cable TV jack) and wallplate kits shall be provided by one manufacturer.

2.02 EQUIPMENT

- A. Controls Lutron Vareo Style
 - 1. Performance
 - a. Dimmers shall provide full-range, continuously variable control of light intensity.
 - b. Controls shall fit a 1 inch wide, 1.5 inch tall wallplate opening with a flush tap switch. Dimmers shall have a small, raised slider to the right of the tap switch. Tap switches shall remain flush with the wallplate in both the on and off state. Controls shall be thin profile with no exposed heatsink/yoke. Unless otherwise specified, controls shall have a matte finish.

- c. When the lights are on, the slider shall change the light level. When the lights are off, the slider shall preselect the light level the lights will turn on to. Tap switch shall turn lights on to the preselected level, or off. Switches shall have a factory set high-end light level.
- d. An actuator accessible from the front of the unit, with the wallplate attached, shall activate a mechanical air-gap switch disconnecting power from the load during "safety off" condition; no leakage current shall be present at the fixture(s). This front accessible safety switch (FASS_m) shall be separate from the tap switch and small slider.
- e. Tap switch, slider and front accessible safety switch (FASS_m) shall be captured behind wallplate.
- f. Controls shall be capable of on/off and mechanical air-gap "safety off" from up to 9 additional locations using aesthetically coordinated auxiliary electronic tap switches.
- g. Within rated capacity, dimmers shall be available for direct control of incandescent, magnetic low voltage, and fluorescent (3-wire line voltage). Coordinated fan-speed controls and electronic tap switches shall also be available.
- h. Controls shall be capable of operating at the rated capacity; this includes modified capacities for ganging configurations which require the removal of fins. Operation at rated capacity shall be possible across the full ambient temperature range, without shortening design lifetime.
- i. To ensure a precise color match between all plastic parts, color variation of any matte finish control shall not exceed a delta E of 1, CIE L*a*b* color units, as defined in ASTM E 308-99.
- j. Dimmer shall provide smooth and continuous Square Law dimming curve, for the full slider travel, on their rated load per The IESNA Lighting Handbook, 9th edition, p. 27-4.
- k. Controls shall meet the applicable requirements of UL 20 and UL 1472 referring to the inclusion of a visible, accessible air-gap off switch and the limited short circuit test.
- l. Controls shall meet ANSI/IEEE Std. C62.41-1980, tested to withstand voltage surges of up to 6000V and current surges of up to 200A without damage.
- m. Dimmers shall be designed to reduce interference with radio, audio, and video equipment.
- n. Controls shall incorporate power-failure memory. Should power be interrupted and subsequently returned, the lights or fans will come back on to the same levels set prior to the power interruption. Restoration to some other default level is not acceptable.
- o. Controls shall not be susceptible to damage or loss of memory due to static discharge.
- p. Dimmer shall include voltage compensation to compensate light output for variation in the AC line-voltage. Dimmers in which the light output is not held constant with varying AC line-voltage shall not be acceptable.
- q. Controls shall operate in an ambient temperature range of 0°C (32°F) to 40°C (104°F).
- r. Auxiliary electronic tap switch shall wire using conventional 3-way and 4-way wire runs.
- s. Contractors shall install all backboxes with a minimum wallbox depth of 2.5 inches.
- 2. Incandescent/Magnetic Low Voltage (MLV) Transformer Dimmers
 - a. Provide incandescent/magnetic low voltage transformer dimmers for direct control of up to 1000 Watts/Volt Amps with hidden locator light.

- b. Dimmers shall have a high-end of no less than 95% of line voltage.
 - c. Dimmer shall be capable of operating in either 3-way switch location.
 - d. Dimmers shall contain circuitry specifically designed to control and provide a symmetrical AC waveform to the input of magnetic low voltage transformers per UL1472 section 5.11.
 - e. Dimmers shall not cause a magnetic low voltage transformer to operate above the transformers rated operating current or temperature.
3. Fluorescent Dimming Ballast Dimmers
- a. Provide Fluorescent dimmers for direct control of fluorescent dimming ballasts up to the manufacturers specified rating.
 - b. Dimmers shall be designed to operate the following ballasts. Dimmers and ballasts shall be produced by the same manufacturer to ensure proper ballast/control compatibility:
 - 1) Hi-lume® Architectural Dimming Ballasts (1% 3-wire)
 - 2) Hi-lume® Compact™ Lamp Dimming Ballasts (5% 3-wire)
 - 3) Eco-10™ Lighting Management Dimming Ballasts (10% 3-wire)
4. Remote dimming modules for high power loads
- a. Where lighting loads exceed the full rated capacity of single dimmers, provide a Vareo incandescent/magnetic low voltage dimmer driving high power modules. High power module and dimmer shall be from the same manufacturer to ensure compatibility.
 - b. High power modules shall be remotely mounted.
 - c. High power module shall be rated and UL listed for control of incandescent, magnetic low voltage, electronic low voltage, fluorescent, and neon/cold cathode loads in increments of 2,000 Watts up to 30,000 Watts.
5. Fan-Speed Controls:
- a. Fan-speed controls shall be UL listed, CSA and NOM approved, Lutron Nova TA style.
 - b. Quiet fan-speed model shall provide three speed settings with slide-to-off function.
 - c. Quiet fan-speed control shall provide single-pole control of one paddle fan (1.5A max.).
 - d. Fully variable model shall provide fully variable fan-speed control with slide-to-off function.
 - e. Fully variable model shall provide single pole control of multiple paddle fans, ventilation or exhaust fans (12A max.).
6. Switches:
- a. Electronic Tap switches shall be available for on/off control of 120VAC incandescent, magnetic low voltage, electronic low voltage, magnetic and electronic fluorescent non-dimmable ballast loads up to 1000W/VA. Electronic Tap switches shall be Lutron Vareo style.
 - b. Electronic Tap switches with status light shall be available for on/off control of 120VAC incandescent, magnetic low voltage, and magnetic fluorescent non-dimmable ballast loads up to 1000W/VA. Electronic Tap switches with status light shall be Lutron Vareo style.
 - c. Auxiliary Electronic Tap switches shall provide multi-location switching and mechanical air-gap switch. Up to 9 Auxiliary switches may be used.
 - d. Switches, for higher capacity or different loads than Electronic Tap switches, shall provide on/off control of any 120/277 VAC load up to 20A. Switches shall be UL listed as general-use AC switches. General-use switches shall be Lutron Nova TA style.
 - e. General-use switches shall be available in single pole, 3-way and 4-way configurations.
- B. Accessories Lutron Nova TA Style
1. Receptacle Components Lutron Nova TA Style
- a. All receptacles shall be UL Listed, CSA and NOM approved.
 - b. Receptacles shall be two pole, three wire ground and rated for 15A or 20A as specified at 125 VAC. All receptacles shall be NEMA configuration type 5-15R or 5-20R.
 - c. Isolated Ground Receptacles shall be Lutron Nova TA style with two pole, three-wire ground and rated 15A or 20A as specified at 125VAC. Configuration shall be of the duplex type with rectangular NEMA WD-6 design. Receptacle face shall be orange with black isolated ground triangle or standard Nova TA colors with orange isolated ground triangle.
 - d. Ground-fault interrupter receptacles shall be Lutron Nova TA style with two-pole, three-wire ground and rated 15A or 20A at 125VAC. Configuration shall be of the duplex type with rectangular NEMA WD-6 design. Receptacles shall have a 5 milliampere ground-fault trip level with "test" and "reset" buttons.
2. Telephone Jack and Cable TV Jack Components Lutron Nova TA Style
- a. Contractor shall provide an appropriate barrier (partition) to isolate jack from high-voltage wiring when ganged with a dimmer, fan-speed control, switch, or receptacle. This complies with NEC Articles 800-3 and 820-13.
 - b. Telephone jacks shall be designed to mate with standard 4- or 6-conductor modular jacks, and be compatible with 2, 4 or 6 conductor lines. Telephone jacks shall meet FCC Part 68, paragraph F standards to ensure compatibility with U.S. telephone systems.
 - c. Eight-conductor telephone jacks shall be Category 5 Voice and Data rated. They shall be FCC Part 68, Sub-part F compliant.
 - d. Cable TV jacks shall be the coaxial type, designed for use with standard 75-Ohm cables.
 - e. Category 5 voice, data, or cable configurations shall be available in single gang, up to three functions per gang.
- C. Wallplates Lutron Nova TA Style
- 1. Wallplates shall be manufactured from durable polycarbonate plastic with matte finish, and shall attach to the basic components without using exposed hardware or screws.
 - 2. Multigang wallplates shall provide a continuous, seamless cover for control and/or accessory combinations with no exposed hardware or screws. Custom wallplate configurations shall be available.
 - 3. Multigang wallplates shall include snap in auto-align adapter plate for proper device alignment and wallplate attachment.
 - 4. Control, accessory and wallplate profiles shall not exceed .30 inches from wall surface to faceplate front surface.
 - 5. To ensure a precise color match between all plastic parts, color variation of any gloss finish control or wallplate shall not exceed delta E of 1, CIE L*a*b* color units, as defined in ASTM E 308-99.

6. Visible parts of dimmers, switches, standard receptacles, cable jacks or any wallplate shall exhibit ultraviolet stability when tested with multiple actinic light sources as defined in ASTM D4674-89.

2.03 SOURCE QUALITY CONTROL

- A. All dimming controls shall be 100% function tested at the time of manufacture. Statistical sampling plan shall not be acceptable.

PART 3 – EXECUTION

3.01 INSTALLATION

- A. Contractor shall furnish all devices (dimmers, accessories, & wallplate kits), labor and other services necessary for the proper installation of the devices as indicated on the drawings and specified herein.
- B. Contractor shall be responsible for derating dimmer capacity if side sections are removed.
- C. Contractor shall run separate neutral wires in 120/208 VAC installations.
- D. Devices shall be installed utilizing manufacturer's recommended application, wiring and installation instructions.
- E. Contractor to provide seamless wallplate covers per specification 2.02 for all devices ganged in a common box. Contractor shall provide barriers within the box where required by code.

3.02 FIELD QUALITY CONTROL

- A. Twenty-four hours a day, seven days a week, global customer service and technical hotline available.
- B. Supplemental information shall be provided by manufacturer's Internet site.