

## Dual Technology Ceiling Mount Sensor



The ULOS-CDT Series ceiling-mount dual-technology sensors can integrate into Lutron systems or function as stand-alone controls using a Lutron power pack. The technology eliminates manual sensitivity and timer adjustments during installation and over the life of the product.

### Features

- Intelligent, continually adapting sensor
- Ultrasonic (US) combined with passive infrared (PIR) sensing provide high sensitivity, high noise immunity, and excellent false tripping immunity
- Suited for complex environments that are difficult to control with single-technology sensors
- Snap-locks to ceiling-mounted cover plate
- Non-Volatile Memory: settings saved in protected memory are not lost during power outages
- 500 to 2000 sq ft (46 to 186 m<sup>2</sup>) coverage when mounted on an 8 - 12 ft (2.4 to 3.7 m) ceiling; 180° and 360° field of view
- Affords choice of turning lights off or dimming to a preset level in the unoccupied state when integrated with a Lutron system.
- Assembled in the USA.

### Models Available

Cat. No.	Color	Coverage	Field of View
ULOS-CDT-500-WH	White	500 sq ft (46 m <sup>2</sup> )	180°
ULOS-CDT-500R-WH	White	500 sq ft (46 m <sup>2</sup> )	180°
ULOS-CDT-1000-WH	White	1000 sq ft (93 m <sup>2</sup> )	180°
ULOS-CDT-1000R-WH	White	1000 sq ft (93 m <sup>2</sup> )	180°
ULOS-CDT-2000-WH	White	2000 sq ft (186 m <sup>2</sup> )	360°
ULOS-CDT-2000R-WH	White	2000 sq ft (186 m <sup>2</sup> )	360°

### Self-Adaptive Feature

The ULOS-CDT Series ceiling-mount occupant sensors combine both (US) motion detection for maximum sensitivity and passive infrared (PIR) motion detection for false triggering immunity. The self-adapting internal microprocessor analyzes the composite sum of both signals to eliminate time-consuming adjustments and callbacks found in non-intelligent sensors.

<b>Job Name:</b>	<b>Model Numbers:</b>
<b>Job Number:</b>	

## Specifications

### Timer Adjustment

- Automatic mode: Continually adapting sensor automatically adjusts settings to the space
- Manual mode: 8 to 30 minutes
- Test mode: 8 seconds

### LED Lamp

- Red: infrared motion detected
- Green: ultrasonic motion detected

### Housing

- Rugged, high-impact, injection-molded plastic
- Color-coded leads 6 in (15 cm)

### Power

- Operating voltage: 20 - 24 V<sub>DC</sub>, PELV (Class 2: USA) low-voltage
- Operating current: 33 mA nominal
- Control output: 20 - 24 V<sub>DC</sub> active high logic control signal with short-circuit protection, open collector when unoccupied

### Operating Environment

- Temperature: 32 to 104 °F (0 to 40 °C)
- Relative humidity: less than 95%, non-condensing
- For indoor use only

### Adaptive Functions

- Installation: 60 minutes
- Learning: 4 weeks for response to error conditions, air current adaptation, and timer optimization
- Post-learning occupancy periods
  - 24-hour circadian occupancy periods learned
  - Weekly occupancy periods learned
- Adjustments in post-learning period
  - Generally occupied periods (threshold = high-sensitivity mode)
  - Generally unoccupied periods (threshold = miser mode)

### Contact Rating (R Models only)

- SPDT 500 mA rated at 24 V<sub>DC</sub> isolated relay

### Photo Cell (R Models only)

- Prevents light from turning on when there is sufficient natural light
- Sensitivity: 0 - 1000 LUX adjustable

## Dimensions

Measurements are in inches (mm)

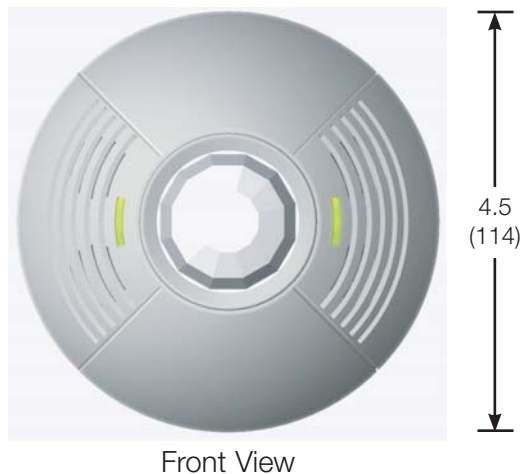

Job Name:

Model Numbers:

Job Number:

## Wiring

Note: Power pack may be required when interfaced to lighting control system; see below.

### Single Sensor to System

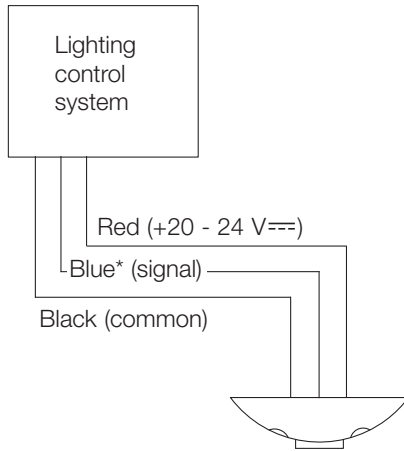

### 2 or More Sensors to System

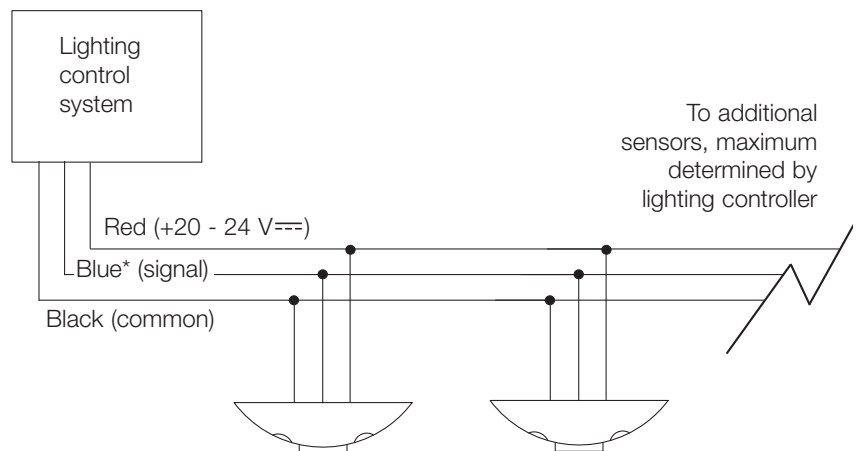

\*Note: Use gray wire for -R model.

## Power Supply Options

### Lutron Lighting Control System

Digital microWATT™

EcoSystem®

GRAFIK 5000 / 6000 / 7000™

GRAFIK Eye® 3000 / 4000

HomeWorks®

LCP128™

microWATT®

RadioRA®

RadioTouch®

Softswitch128®

### Power Pack Required?

No

No

No, when used with seeTouch® wallstations with occupant sensor connections.

Yes

Yes

No, when used with seeTouch® wallstations with occupant sensor connections.

No

Yes

No

No, when used with seeTouch® wallstations with occupant sensor connections.

**NOTE:** Power Pack may be required for more than one Occupant Sensor. Consult factory for multiple sensor requirements.

Job Name:

Model Numbers:

Job Number:

## Wiring: Stand-Alone Control

### 1 to 3 Sensors with Power Pack

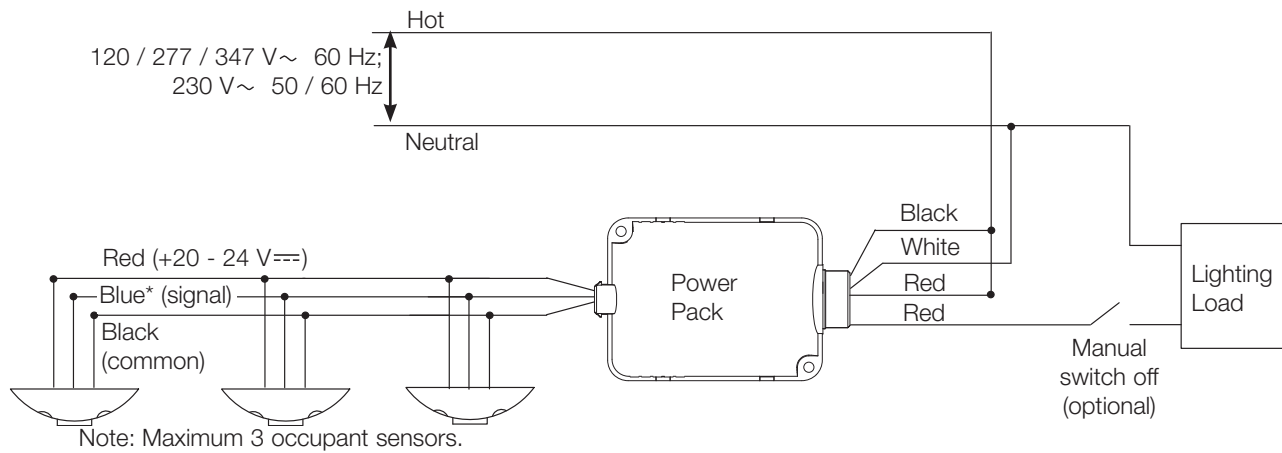

### Switching Multiple Loads with Auxiliary Power Packs

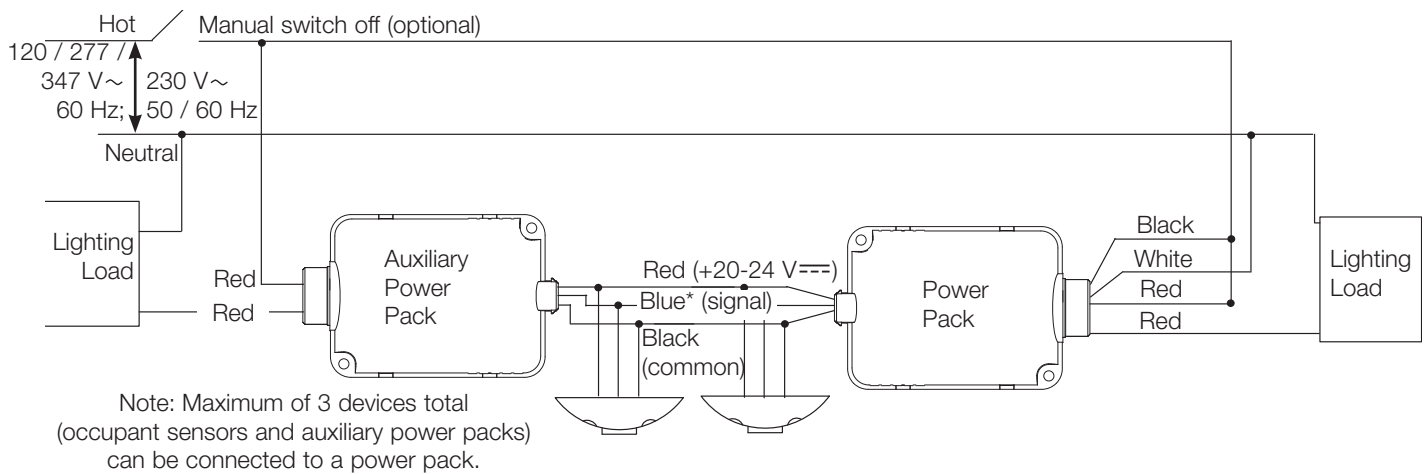

\*Note: Use gray wire for -R model.

Job Name:

Model Numbers:

Job Number:

# Wiring

## Relay Model Option

LOS-CDT-xxxxR only

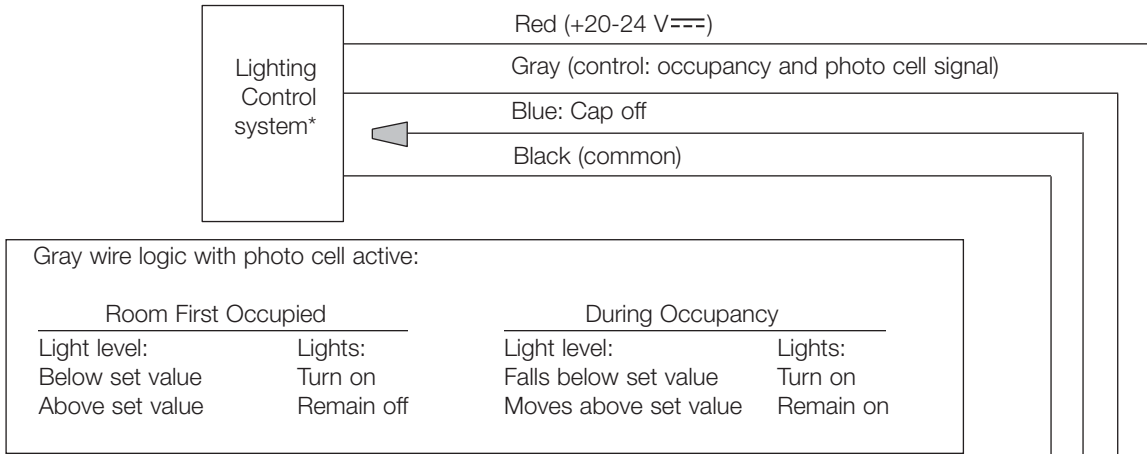

\*Note: May require power pack

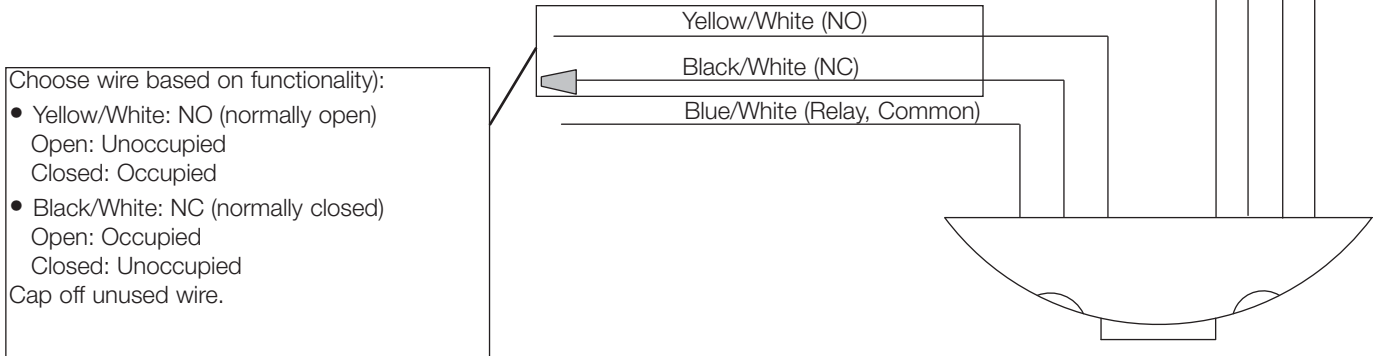

<b>Job Name:</b>	<b>Model Numbers:</b>
<b>Job Number:</b>	

## Installation

### Sensor Placement

- The occupant sensor must have an unobstructed view of the room. Do not mount behind or near tall cabinets, shelves, indirect hanging fixtures, etc.
- Do not place sensor within 6 ft (1.8 m) of air vents, air handlers, windows, fans, etc., as this may cause false triggering.
- If installing a 180° occupant sensor (500 and 1000 models), place the sensor on the same wall as the doorway so that traffic in a hallway will not affect the sensor; otherwise, place in center of room.
- Closely follow the diagrams shown concerning major and minor motion coverage. The sensor can detect major motion (such as a person taking a half-step) at a greater distance than it can detect minor motion (such as writing or typing at a desk).
- Decrease total coverage area by 15% for “soft” rooms (for example, heavy draperies or heavy carpeting).

### Range Diagrams

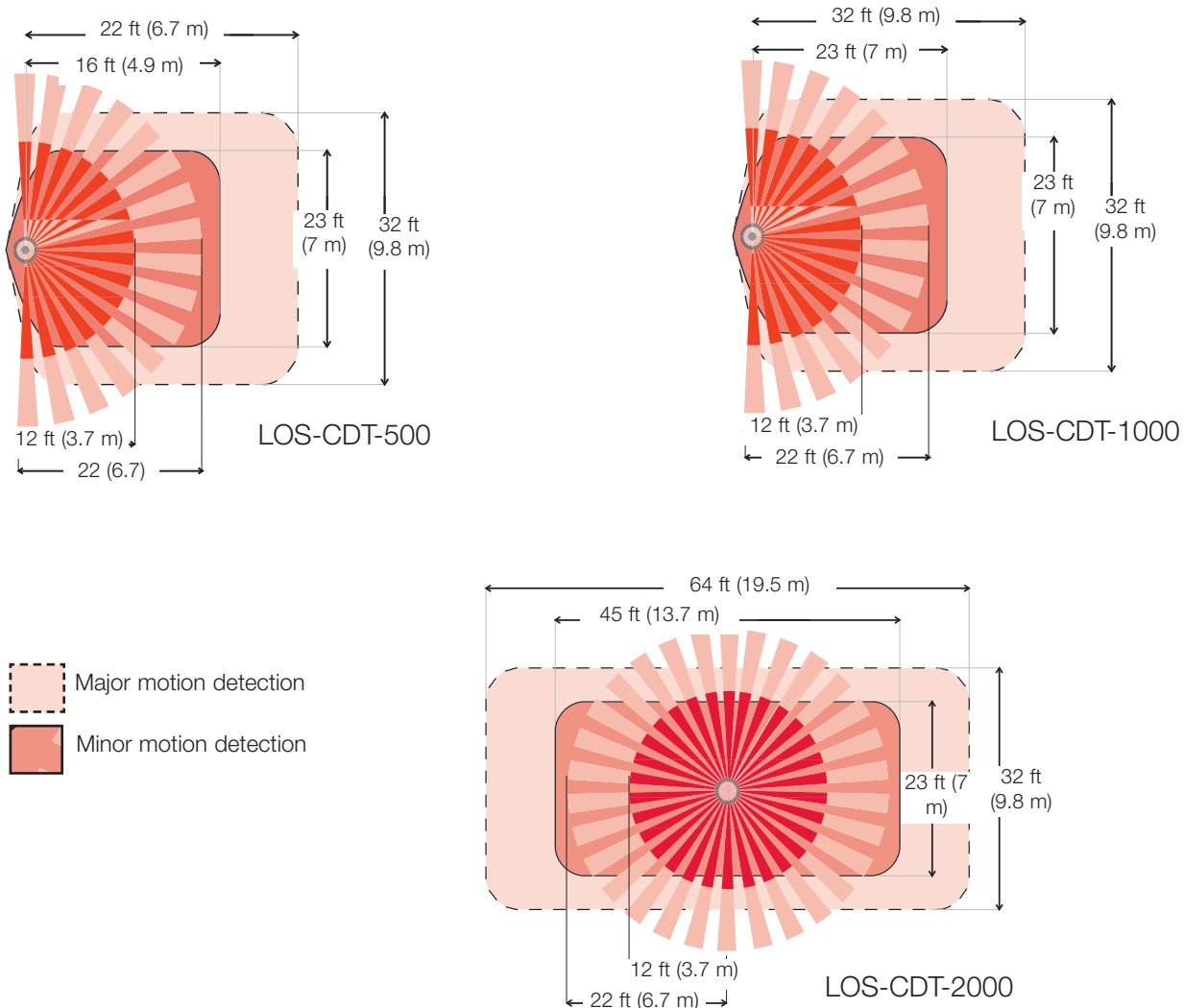

Job Name:

Model Numbers:

Job Number:

## Installation

### Mounting

#### Normal Mounting

Twist and lock threaded mounting post onto cover plate. Drill through ceiling tile with assembly, using cutter end of the threaded mounting post. Secure with washer and nut.

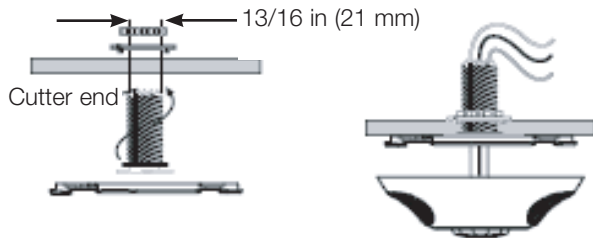

#### Mounting to Non-Standard Ceiling or Fixture

Mount twist-lock cover plate using mounting screws, nuts, and washers (included). Drill/punch wire routing hole through ceiling tile at center of cover plate.

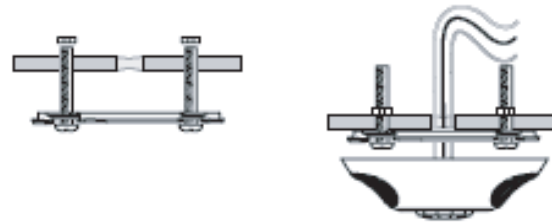

Mounting Plate Dimensions

### Wire Lengths

# Sensors	1	2	3	1	2	1
# Aux. PP	0	0	0	1	1	2
22 AWG	750 ft	375 ft	250 ft	375 ft	250 ft	250 ft
0.5 mm <sup>2</sup>	365 m	180 m	120 m	90 m	120 m	120 m
20 AWG	1200 ft	600 ft	400 ft	600 ft	400 ft	400 ft
0.75 mm <sup>2</sup>	730 m	365 m	240 m	365 m	240 m	365 m
18 AWG	2400 ft	1200 ft	800 ft	1200 ft	800 ft	800 ft

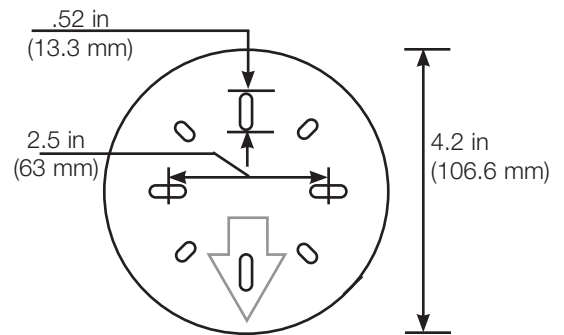

### Using the Infrared Mask

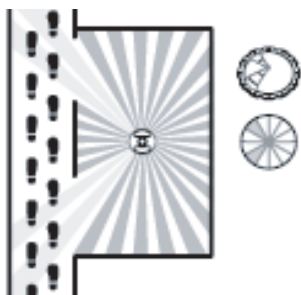

Center Ceiling Mount  
(Mask blocks sensor seeing out doorway into hall)

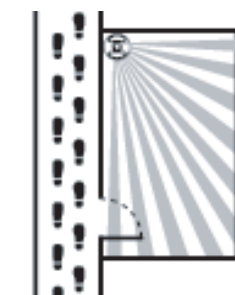

Corner Ceiling Mount  
(No mask needed)

### Typical Mask Patterns



Conference Room Mask



180° Mask



Full Mask



Rectangular Areas



Over the Door



Specific Areas You Wish to Mask



Job Name:

Model Numbers:

Job Number:

## Sensor Adjustments

### Override Settings

		A	Off (Default)	On
Auto/Manual	<input type="checkbox"/>	1	Automatic (Normal)	Manual on/off (Override)
Threshold	<input type="checkbox"/>	2	Auto Threshold Adjustment	High Sensitivity (Low turn-on threshold)
LED Motion Indicator	<input type="checkbox"/>	3	Lights indicate motion	Disable LED Indicator
Reset Learned Settings	<input type="checkbox"/>	4	Retain Settings (Normal)	Erase all learned settings, restart Learning (Toggle On)
				
		B	Off	On
Strong Airflow Compensation	<input type="checkbox"/>	1	Disable Compensation (Normal)	Enable Compensation
Over Doorway Installation	<input type="checkbox"/>	2	No (Normal)	Yes (Use increased turn-on threshold)
Timer Adjust	<input type="checkbox"/>	3	Adjust Timer Automatically	Use Manual Setting (No adjustment)
Auto Sensitivity	<input type="checkbox"/>	4	Adjust Sensitivity Automatically	Adjust Sensitivity Manually
				

### Timer Test Mode

1. Remove the retainer cover.
2. Rotate the black timer adjustment knob to about midway (12 o'clock).
3. Return setting to minimum setting (full CCW).



Factory Settings

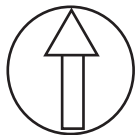

12 o'clock

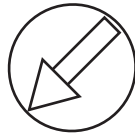

Full CCW

Note: The timer will remain in the 8-second test mode for 1 hour, then automatically reset to 8 minutes.

4. To manually take the timer out of the 8-second test mode, turn the timer adjustment approximately 1/16 in (1.5 mm) clockwise to make the setting slightly above minimum (just above the 8-minute setting).

### Factory Settings

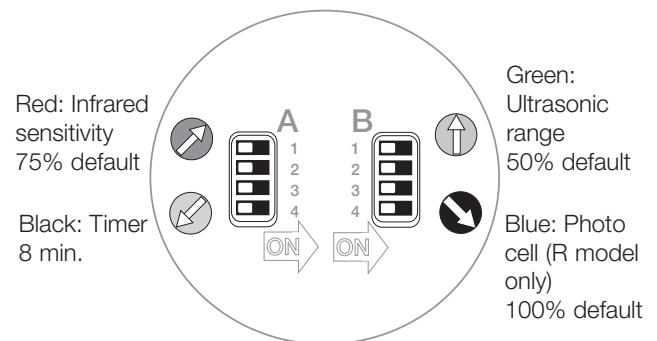

Job Name:

Model Numbers:

Job Number:



## Installation

### Adjusting the “Lights Not On” Level

ULOS-CDT-xxxxR only

1. Place timer in Test Mode (see page 7).
2. Set photo cell to max.  
Turn the blue knob full clockwise (lights on no matter how bright the natural light is), then about 30 degrees counterclockwise.
3. Check for Lights-Out.  
Move from underneath the sensor, and remain still until the lights turn off. Move around normally to turn the light on.
4. Adjust to desired level.  
If lights remain off, adjust the blue knob another 30 degrees counterclockwise and repeat step 3 until the lights turn on.

**Note:** Set blue knob to 100% to disable photo cell functionality and leave secondary dry contact closure output functionality intact.

### Control Settings (Blue Knob)

ULOS-CDT-xxxxR only

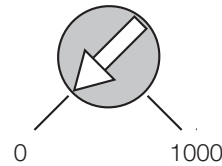

Minimum (low):  
Lights will never come on, even though room is occupied.

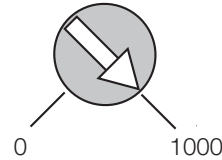

Maximum (high):  
Photo cell has no effect on operation (factory setting).

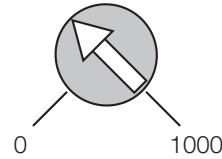

Normal:  
200 to 600 LUX is normal range.

Job Name:

Model Numbers:

Job Number: