

Color and Engraving Codes

QSW2-1BN-___-___

QSW2-1BI-___-___

1-Button Wallstation

Description

- Offers toggle functionality for any combination of zone(s) in the system.
- Receives up to two contact closure inputs through a connector on the back of the wallstation.
- Large, rounded buttons are easy to use.
- Backlit buttons with optional engraving make it easy to find and operate the wallstation in low-light conditions.
- Optional button engraving is angled up to the eye for easy reading.
- The LEDs next to each button are used during programming and provide feedback when the buttons are pressed.

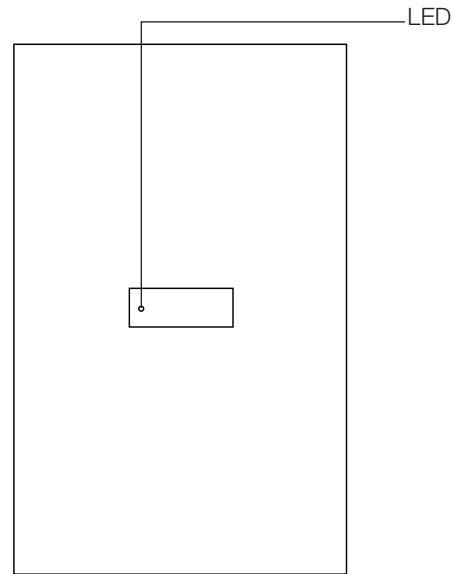

QSW2-1BN-WH
(Non-insert version)

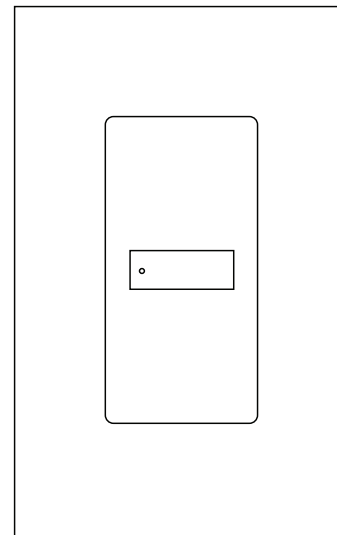

QSW2-1BI-WH
(Insert version)

| | |
|-------------|----------------|
| Job Name: | Model Numbers: |
| Job Number: | |

Color and Engraving Codes (continued)

QSW2-2BN-___-___

QSW2-2BI-___-___

2-Button Wallstation

Description

- Often used in entryways to select Scene 1 and Off.
- Receives up to two contact closure inputs through a connector on the back of the wallstation.
- Large, rounded buttons are easy to use.
- Backlit buttons with optional engraving make it easy to find and operate the wallstation in low-light conditions.
- Optional button engraving is angled up to the eye for easy reading.
- The LEDs next to each button are used during programming and provide feedback when the buttons are pressed.

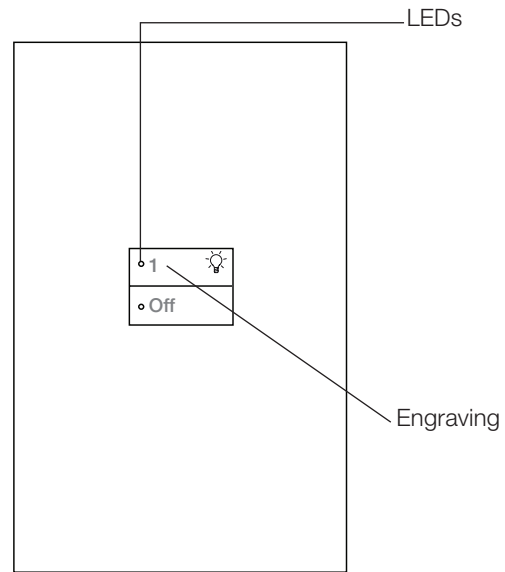

QSW2-2BN-WH-EGN
(Non-insert version)

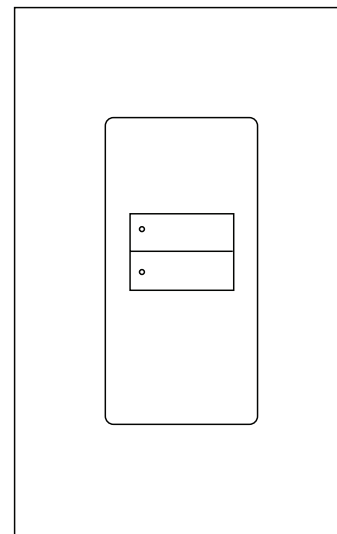

QSW2-2BI-WH
(Insert version)

| | |
|-------------|----------------|
| Job Name: | Model Numbers: |
| Job Number: | |

Color and Engraving Codes (continued)

QSW2-3BN-___-___

QSW2-3BI-___-___

3-Button Wallstation

Description

- Often used to select scenes.
- Receives up to two contact closure inputs through a connector on the back of the wallstation.
- Large, rounded buttons are easy to use.
- Backlit buttons with optional engraving make it easy to find and operate the wallstation in low-light conditions.
- Optional button engraving is angled up to the eye for easy reading.
- The LEDs next to each button are used during programming and provide feedback when the buttons are pressed.

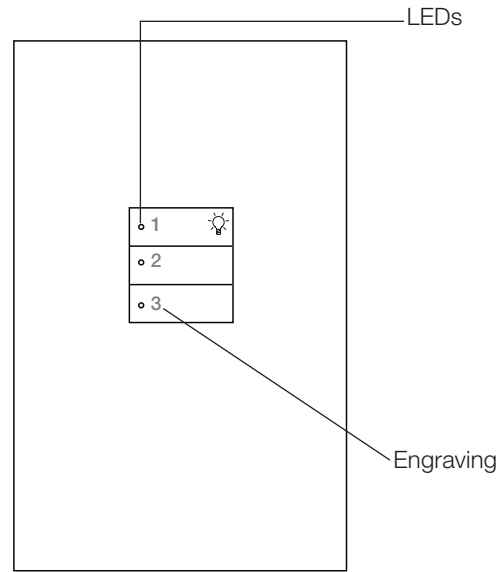

QSW2-3BN-WH-EGN
(Non-insert version)

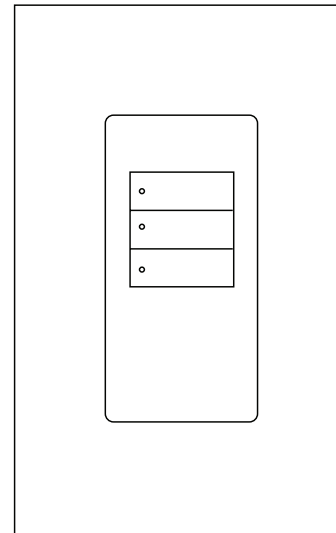

QSW2-3BI-WH
(Insert version)

| | |
|--|-----------------------|
| <p>Job Name:</p> <p>Job Number:</p> | <p>Model Numbers:</p> |
|--|-----------------------|

Color and Engraving Codes (continued)

QSWS2-5BN-____-____

QSWS2-5BI-____-____

5-Button Wallstation

Description

- Often used to select between 4 scenes and Off.
- Receives up to two contact closure inputs through a connector on the back of the wallstation.
- Large, rounded buttons are easy to use.
- Backlit buttons with optional engraving make it easy to find and operate the wallstation in low-light conditions.
- Optional button engraving is angled up to the eye for easy reading.
- The LEDs next to each button are used during programming and provide feedback when the buttons are pressed.

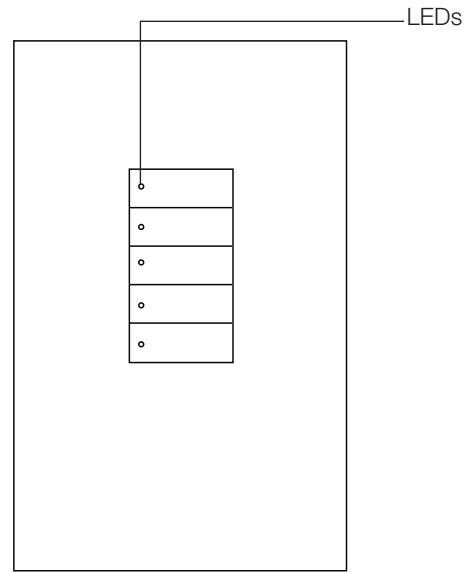

QSWS2-5BN-WH
(Non-insert version)

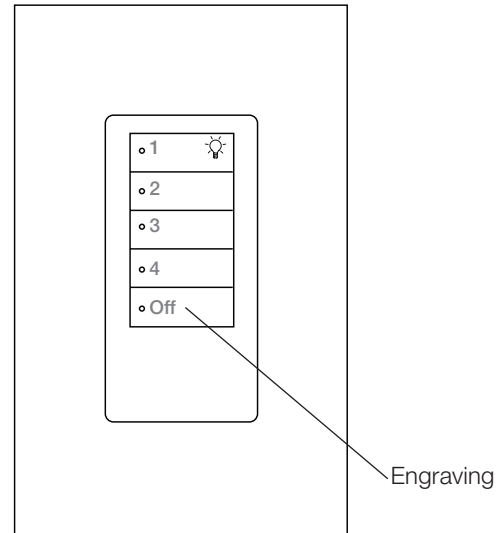

QSWS2-5BI-WH-EGN
(Insert version)

| | |
|-------------|----------------|
| Job Name: | Model Numbers: |
| Job Number: | |

Color and Engraving Codes (continued)

QSWS2-7BN-____-____

QSWS2-7BI-____-____

7-Button Wallstation

Description

- Often used to select scenes.
- Receives up to two contact closure inputs through a connector on the back of the wallstation.
- Large, rounded buttons are easy to use.
- Backlit buttons with optional engraving make it easy to find and operate the wallstation in low-light conditions.
- Optional button engraving is angled up to the eye for easy reading.
- The LEDs next to each button are used during programming and provide feedback when the buttons are pressed.

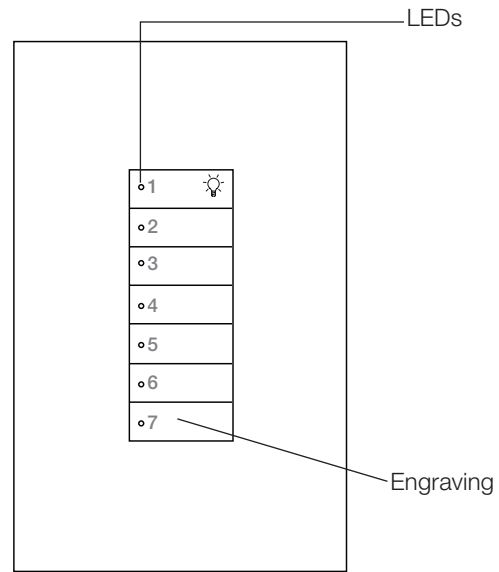

QSWS2-7BN-WH-EGN
(Non-insert version)

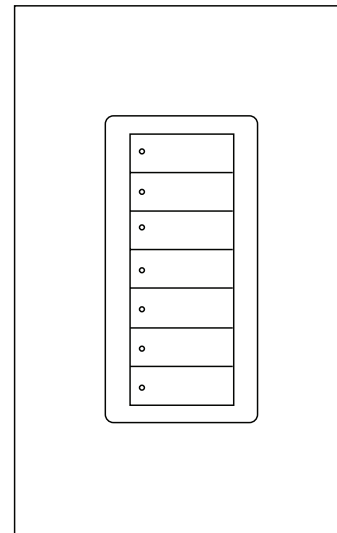

QSWS2-7BI-WH
(Insert version)

| | |
|-------------|----------------|
| Job Name: | Model Numbers: |
| Job Number: | |

Color and Engraving Codes (continued)

QSWS2-2BRLN-____-____

QSWS2-2BRLI-____-____

2-Button Wallstation with Raise/Lower

Description

- Often used to select and adjust scenes.
- Receives up to two contact closure inputs through a connector on the back of the wallstation.
- Large, rounded buttons are easy to use.
- Backlit buttons with optional engraving make it easy to find and operate the wallstation in low-light conditions.
- Optional button engraving is angled up to the eye for easy reading.
- Master Raise/Lower brightens or dims all lighting or raises/lowers all assigned shades in the last selected scene or toggled group.
- The LEDs next to each button are used during programming and provide feedback when the buttons are pressed.
- Shade control features (E01 engraving):
 - Can control Sivoia QS window treatments.
 - Pressing the Open (or Close) button once will cause the window treatments to move to their fully open (or closed) position. Tap any button (regardless of function) to stop a shade that is in motion.

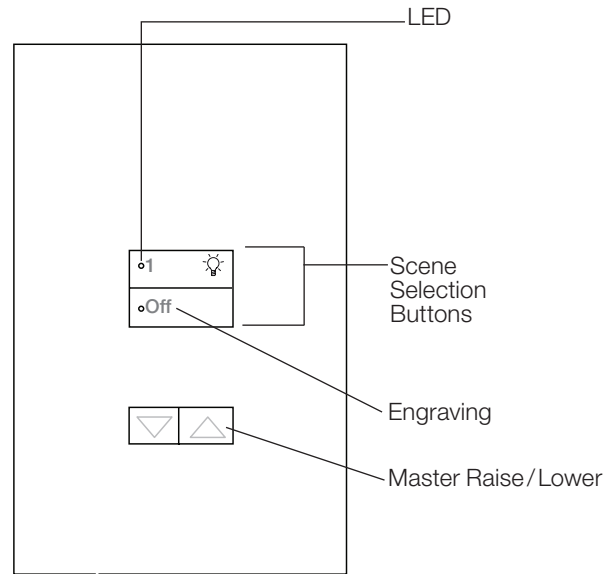

QSWS2-2BRLN-WH-EGN
(Non-insert version)

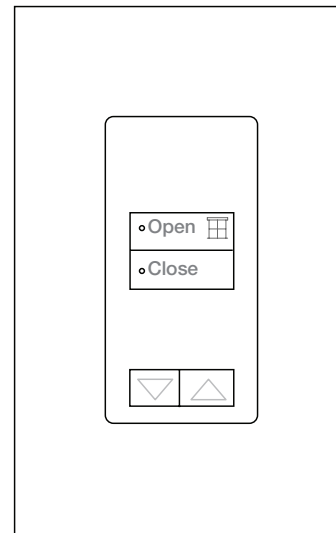

QSWS2-2BRLI-WH-E01
(Insert version)

| | |
|-------------|----------------|
| Job Name: | Model Numbers: |
| Job Number: | |

Color and Engraving Codes (continued)

QSW2-3BRLN-____-____

QSW2-3BRLI-____-____

3-Button Wallstation with Raise/Lower

Description

- Often used to select and adjust scenes.
- Receives up to two contact closure inputs through a connector on the back of the wallstation.
- Large, rounded buttons are easy to use.
- Backlit buttons with optional engraving make it easy to find and operate the wallstation in low-light conditions.
- Optional button engraving is angled up to the eye for easy reading.
- Master Raise/Lower brightens or dims all lighting or raises/lowers all assigned shades in the last selected scene or toggled group.
- The LEDs next to each button are used during programming and provide feedback when the buttons are pressed.
- Shade control features (E01 engraving):
 - Can control Sivoia QS window treatments.
 - Pressing the Open (or Close) button once will cause the window treatments to move to their fully open (or closed) position. Tap any button (regardless of function) to stop a shade that is in motion.
 - One (1) programmable preset button.

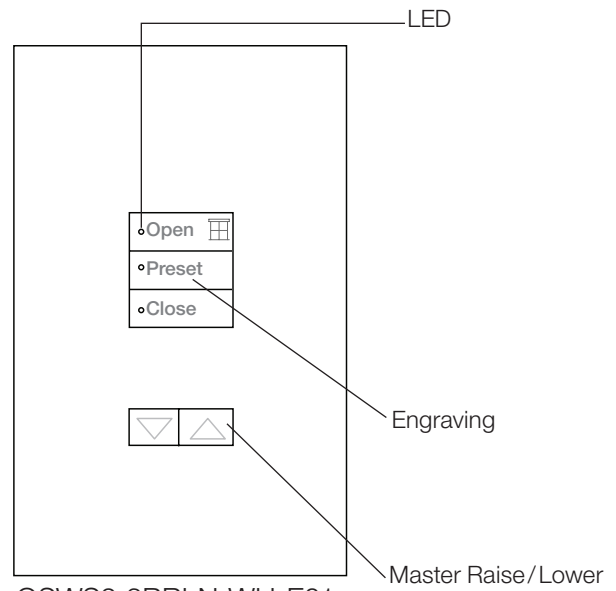

QSW2-3BRLN-WH-E01
(Non-insert version)

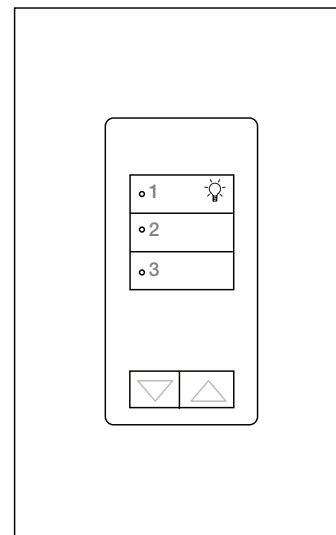

QSW2-3BRLI-WH-EGN
(Insert version)

| | |
|-------------|----------------|
| Job Name: | Model Numbers: |
| Job Number: | |

Color and Engraving Codes (continued)

QSW2-5BRLN-___-___

QSW2-5BRLI-___-___

5-Button Wallstation with Raise/Lower

Description

- Often used to select and adjust scenes.
- Receives up to two contact closure inputs through a connector on the back of the wallstation.
- Large, rounded buttons are easy to use.
- Backlit buttons with optional engraving make it easy to find and operate the wallstation in low-light conditions.
- Optional button engraving is angled up to the eye for easy reading.
- Master Raise/Lower brightens or dims all lighting or raises/lowers all assigned shades in the last selected scene or toggled group.
- The LEDs next to each button are used during programming and provide feedback when the buttons are pressed.
- Shade control features (E01 engraving):
 - Can control Sivoia QS window treatments.
 - Pressing the Open (or Close) button once will cause the window treatments to move to their fully open (or closed) position. Tap any button (regardless of function) to stop a shade that is in motion.
 - Three (3) programmable preset buttons.

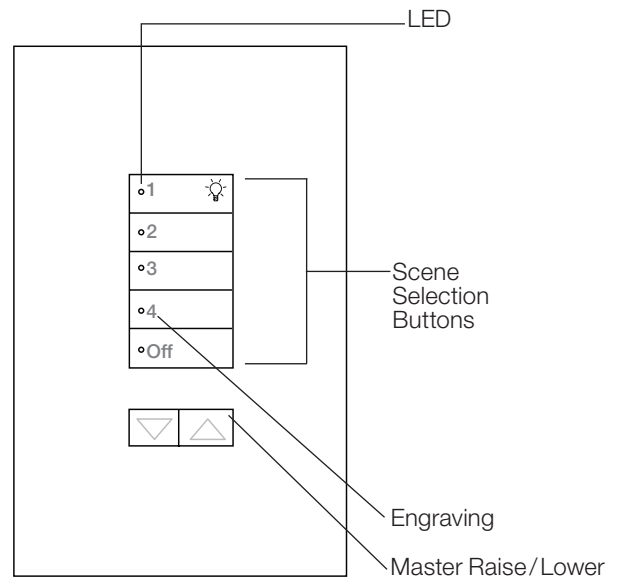

QSW2-5BRLN-WH-EGN
(Non-insert version)

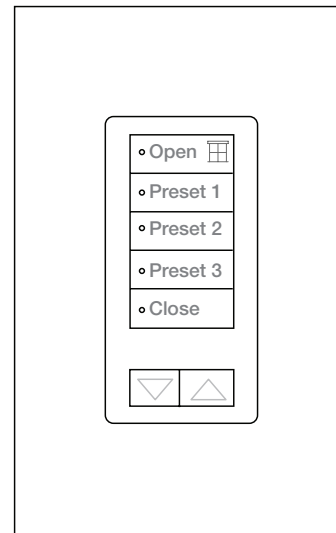

QSW2-5BRLI-WH-E01
(Insert version)

| | |
|-------------|----------------|
| Job Name: | Model Numbers: |
| Job Number: | |

Color and Engraving Codes (continued)

QSW2-2BRLIRN-____-____

QSW2-2BRLIRI-____-____

2-Button Wallstation with Infrared (IR) Receiver and Raise/Lower

Description

- Often used to select and adjust scenes.
- Receives up to two contact closure inputs through a connector on the back of the wallstation.
- Large, rounded buttons are easy to use.
- Backlit buttons with optional engraving make it easy to find and operate the wallstation in low-light conditions.
- Optional button engraving is angled up to the eye for easy reading.
- Master Raise/Lower brightens or dims all lighting or raises/lowers all assigned shades in the last selected scene or toggled group.
- The LEDs next to each button are used during programming and provide feedback when the buttons are pressed.
- Shade control features (E01 engraving):
 - Can control Sivoia QS window treatments.
 - Pressing the Open (or Close) button once will cause the window treatments to move to their fully open (or closed) position. Tap any button (regardless of function) to stop a shade that is in motion.

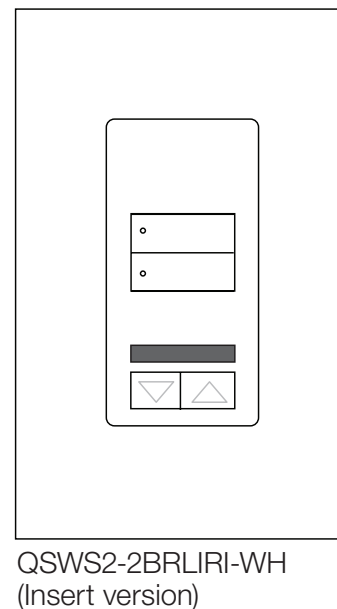
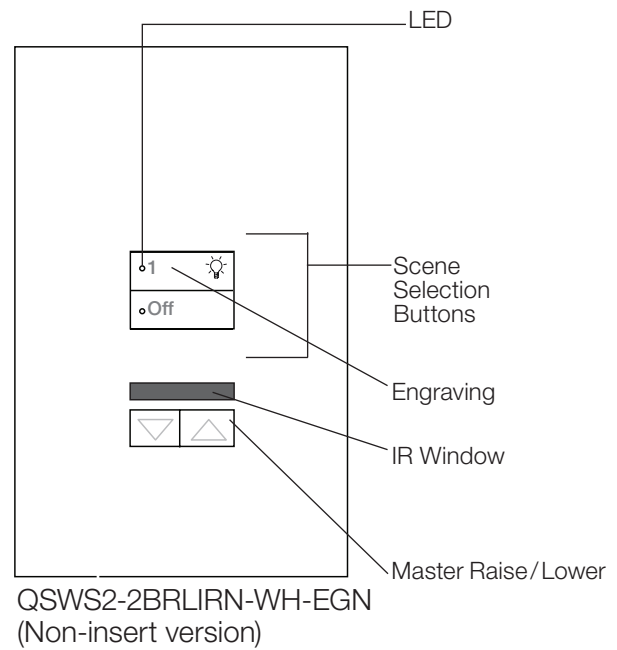

| | |
|-------------|----------------|
| Job Name: | Model Numbers: |
| Job Number: | |

Color and Engraving Codes (continued)

QSW2-3BRLIRN-____-____

QSW2-3BRLIRI-____-____

3-Button Wallstation with Infrared Receiver and Raise/Lower

Description

- Often used to select and adjust scenes.
- Receives up to two contact closure inputs through a connector on the back of the wallstation.
- Large, rounded buttons are easy to use.
- Backlit buttons with optional engraving make it easy to find and operate the wallstation in low-light conditions.
- Optional button engraving is angled up to the eye for easy reading.
- Master Raise/Lower brightens or dims all lighting or raises/lowers all assigned shades in the last selected scene or toggled group.
- The LEDs next to each button are used during programming and provide feedback when the buttons are pressed.
- Shade control features E01 engraving):
 - Can control Sivoia QS window treatments.
 - Pressing the Open (or Close) button once will cause the window treatments to move to their fully open (or closed) position. Tap any button (regardless of function) to stop a shade that is in motion.
 - One (1) programmable preset button.

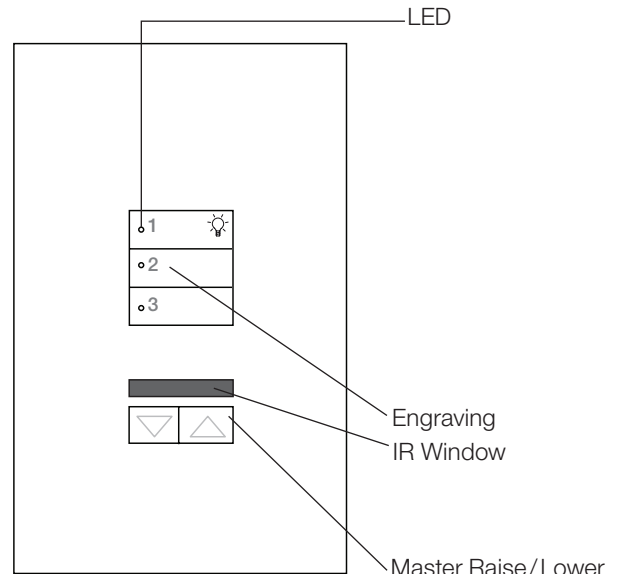

QSW2-3BRLIRN-WH-EGN
(Non-insert version)

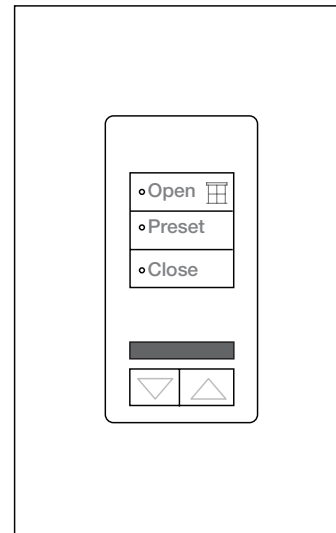

QSW2-3BRLIRI-WH-E01
(Insert version)

| | |
|--|-----------------------|
| <p>Job Name:</p> <p>Job Number:</p> | <p>Model Numbers:</p> |
|--|-----------------------|

Color and Engraving Codes (continued)

QSW2-5BRLIRN-____-____

QSW2-5BRLIRI-____-____

5-Button Wallstation with Infrared Receiver and Raise/Lower

Description

- Often used to select and adjust scenes.
- Receives up to two contact closure inputs through a connector on the back of the wallstation.
- Large, rounded buttons are easy to use.
- Backlit buttons with optional engraving make it easy to find and operate the wallstation in low-light conditions.
- Optional button engraving is angled up to the eye for easy reading.
- Master Raise/Lower brightens or dims all lighting or raises/lowers all assigned shades in the last selected scene or toggled group.
- The LEDs next to each button are used during programming and provide feedback when the buttons are pressed.
- Shade control features (E01 engraving):
 - Can control Sivoia QS window treatments.
 - Pressing the Open (or Close) button once will cause the window treatments to move to their fully open (or closed) position. Tap any button (regardless of function) to stop a shade that is in motion.
 - Three (3) programmable preset buttons.

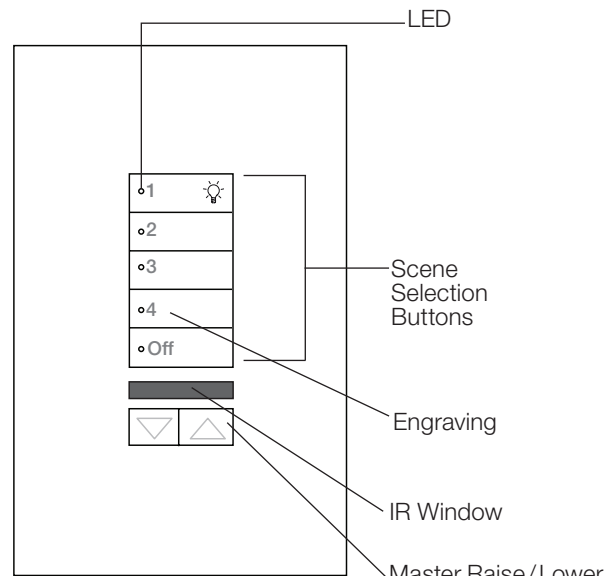

QSW2-5BRLIRN-WH-EGN
(Non-insert version)

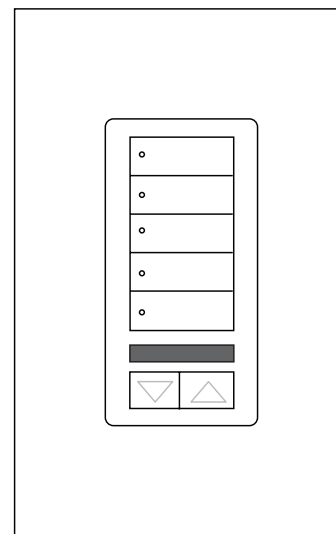

QSW2-5BRLIRI-WH
(Insert version)

| | |
|-------------|----------------|
| Job Name: | Model Numbers: |
| Job Number: | |

Color and Engraving Codes (continued)

QSW2-1RLDN-____-____

QSW2-1RLDI-____-____

Dual Wallstation with 3-Button and 2-Button with Raise/Lower

Description

- Used to control one or more lighting or window treatment groups simultaneously.
- Functions as two independently programmable controllers: a 3-button (top keypad group) and a 2-button (bottom keypad group). Can control two lighting zones, two shade zones, or one of each.
- Receives up to two contact closure inputs through a connector on the back of the wallstation.
- Large, rounded buttons are easy to use.
- Backlit buttons with on-button engraving make it easy to find and operate the wallstation in low-light conditions.
- Optional button engraving is angled up to the eye for easy reading.
- The LEDs next to each button are used during programming and provide feedback when the buttons are pressed.
- Shade control features (E01 engraving):
 - Used to control multiple groups of shades independently from a single-gang keypad (e.g., a window with a sheer shade and a blackout shade).
 - Often used to select three different groups of shades using Open, Close, and Raise/Lower.
 - Can control Sivoia QS window treatments.
 - Pressing the Open (or Close) button once will cause the window treatments to move to their fully open (or closed) position. Tap any button (regardless of function) to stop a shade that is in motion.

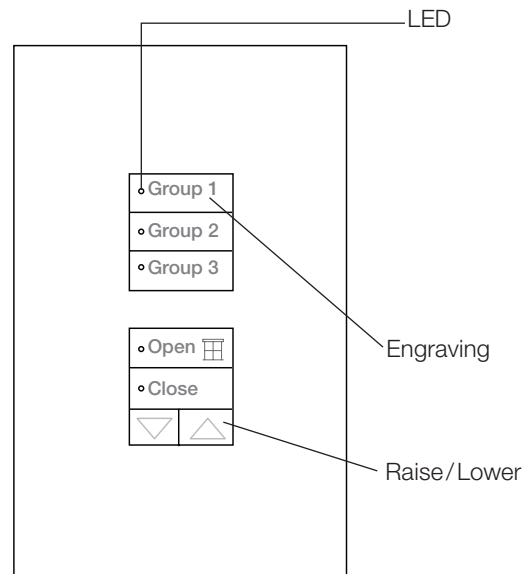

QSW2-1RLDN-WH-E01
(Non-insert version)

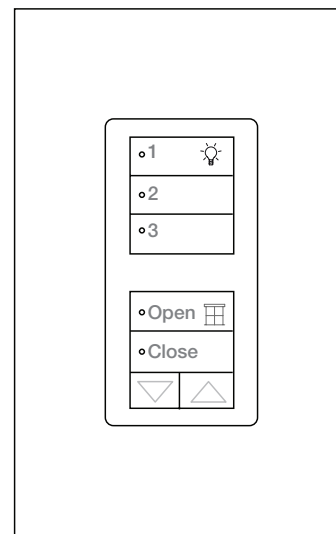

QSW2-1RLDI-WH-EGN
(Insert version)

| | |
|-------------|----------------|
| Job Name: | Model Numbers: |
| Job Number: | |

Color and Engraving Codes (continued)

QSW2-2RLDN-____-____

QSW2-2RLDI-____-____

Dual 2-Button Wallstation with Raise/Lower

Description

- Used to control one or more lighting or window treatment groups simultaneously.
- Functions as two independently programmable 2-button controllers. Can control two lighting zones, two shade zones, or one of each.
- Receives up to two contact closure inputs through a connector on the back of the wallstation.
- Large, rounded buttons are easy to use.
- Backlit buttons with on-button engraving make it easy to find and operate the wallstation in low-light conditions.
- Optional button engraving is angled up to the eye for easy reading.
- The LEDs next to each button are used during programming and provide feedback when the buttons are pressed.
- Shade control features (E01 engraving):
 - Can be used to control multiple groups of shades independently from a single-gang keypad (e.g., a window with a sheer shade and a blackout shade).
 - Can control Sivoia QS window treatments.
 - Pressing the Open (or Close) button once will cause the window treatments to move to their fully open (or closed) position. Tap any button (regardless of function) to stop a shade that is in motion.

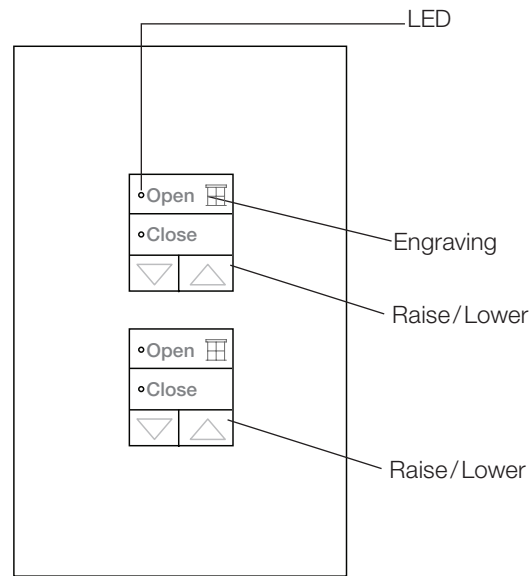

QSW2-2RLDN-WH-E01
(Non-insert version)

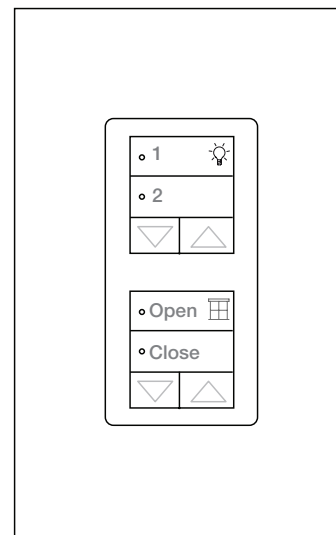

QSW2-2RLDI-WH-EGN
(Insert version)

| | |
|--|-----------------------|
| <p>Job Name:</p> <p>Job Number:</p> | <p>Model Numbers:</p> |
|--|-----------------------|

Color and Engraving Codes (continued)

QSW2-3BDI-____-____

QSW2-3BDN-____-____

Dual 3-Button Wallstation

Description

- Used to control one or more lighting or window treatment groups simultaneously.
- Functions as two independently programmable 3-button controllers. Can control two lighting zones, two shade zones, or one of each.
- Receives up to two contact closure inputs through a connector on the back of the wallstation.
- Large, rounded buttons are easy to use.
- Backlit buttons with on-button engraving make it easy to find and operate the wallstation in low-light conditions.
- Optional button engraving is angled up to the eye for easy reading.
- The LEDs next to each button are used during programming and provide feedback when the buttons are pressed.
- Shade control features (E01 engraving):
 - Can be used to control multiple groups of shades independently from a single-gang keypad (e.g., a window with a sheer shade and a blackout shade).
 - Can control Sivoia QS window treatments.
 - Pressing the Open (or Close) button once will cause the window treatments to move to their fully open (or closed) position. Tap any button (regardless of function) to stop a shade that is in motion.
 - One (1) programmable preset button per 3-button column.

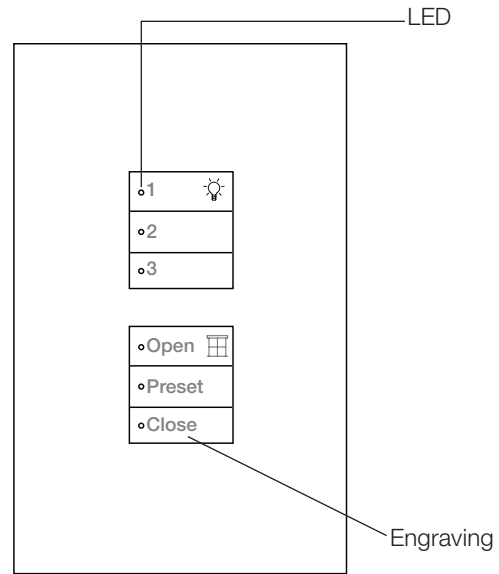

QSW2-3BDN-WH-EGN (Non-insert version)

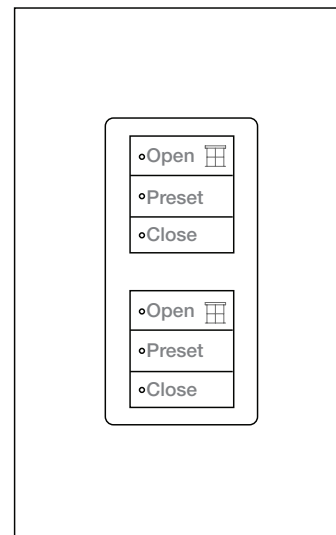

QSW2-3BDI-WH-E01 (Insert version)

| | |
|-------------|----------------|
| Job Name: | Model Numbers: |
| Job Number: | |

Specifications

Power Input (Control Link Terminal 2)

SELV/PELV/NEC® Class 2. Operating voltage: 24–36 V_{DC} 30 mA

Key Design Features

- Field-changeable button and faceplate assemblies allow easy customization.
- Meets IEC 801-2. Tested to withstand 15 kV electrostatic discharge without damage or memory loss.
- Faceplate snaps on with no visible means of attachment.
- Available as an “insert” style control for multigang.
- Can be ganged to share a common faceplate with Nova T[☆] and Vareo dimmers. To order new wallplates for multi-gang, specify “R3” openings in a Nova T[☆] multi-gang FB (fins broken) series model number.
- Use Faceplate Replacement Kits to change color, button configuration, or engraving, or to convert between non-insert and insert configurations.

System Communications and Capacity

- SELV/PELV/NEC® Class 2 wiring connects wallstations to other devices on the QS Link.
- A QS system can have up to 100 devices and 100 zones; seeTouch QS wallstations each count as one device and zero zones on the QS Link.
- A seeTouch QS wallstation consumes one power draw unit (PDU) on the QS link. For complete information, see **Power Draw Units on the QS Link** (P/N 369405) at www.lutron.com

Terminals

Accept up to two 18 AWG (1.0 mm²).

Environment

- 32 °F to 104 °F (0 °C to 40 °C). Relative humidity less than 90% non-condensing.
- For indoor use only.

Compatibility

seeTouch QS keypads are compatible with GRAFIK Eye QS, Sivoia QS, Energi Savr Node, and Quantum systems.

Mounting

Typical backbox dimensions:
 3.75 in (95 mm) high,
 2.1875 in (55 mm) wide,
 2.75 in (70 mm) deep.

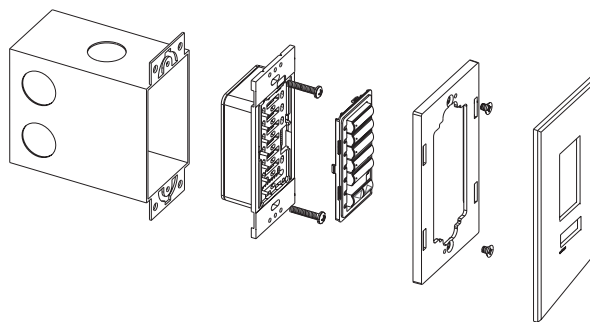

Dimensions

Front View

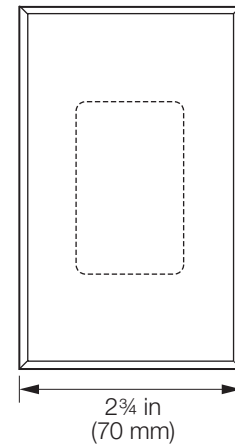

Side View

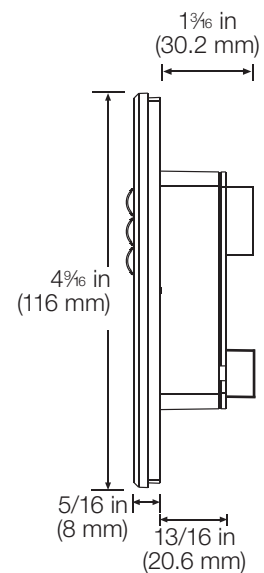

Back View

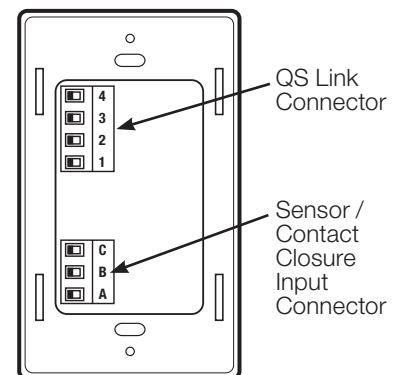

⚠ WARNING – Entrapment Hazard – To avoid the risk of entrapment, serious injury, or death, these controls must not be used to control equipment that is not visible from every control location or that could create hazardous situations if operated accidentally or through malfunction (for example, motorized gates, garage doors, industrial doors, microwave ovens, heating pads, fireplaces, space heaters, etc.). It is the installer’s responsibility to ensure that these controls are connected only to suitable loads and equipment types and that such equipment is visible from every control location. Failure to do so could result in serious injury or death.

| | |
|-------------|----------------|
| Job Name: | Model Numbers: |
| Job Number: | |

Available Control Types

seeTouch wallstations are available in three types:

Lights Only

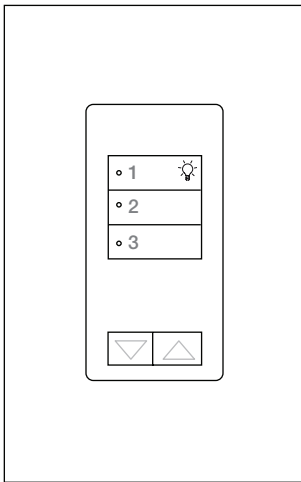

QSWS2-3BRLI-WH-EGN
(Insert version)

Lights and Shades

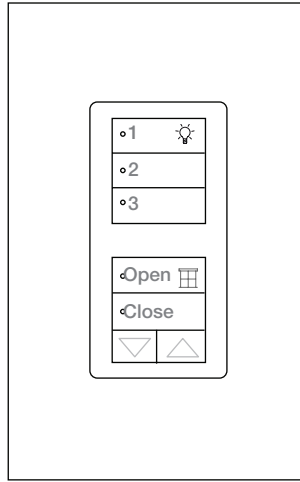

QSWS2-1RLDI-WH-EGN
(Insert version)

Shades Only

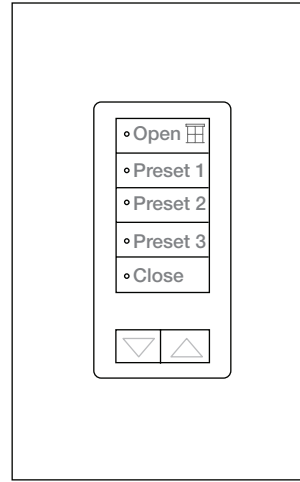

QSWS2-5BRLI-WH-E01
(Insert version)

Lights Only

- Controls only lights.
- Has a programmable column type (choose from the list on the following pages).
- Engraving options: General (EGN) and Non-Standard (NST).

Lights and Shades

- Top column controls only lights and has a programmable column type (choose from the list on the following pages).
- Bottom column controls only shades and has a programmable column type (choose from the list on the following pages).
- Engraving options: General (EGN) and Non-Standard (NST).

Shades Only

- Controls only shades.
- Models with preset buttons have programmable preset levels.
- Engraving options: Standard (E01), Secondary (E02), and Non-Standard (NST).

| | |
|-------------|----------------|
| Job Name: | Model Numbers: |
| Job Number: | |

Available Column Types

Scene (with Off)

- Controls pre-programmed scenes on one or more scene controllers (such as a GRAFIK Eye QS, or an area on an Energi Savr Node).
- Buttons within a column control the same scene controller(s) (different buttons within a column cannot control different scene controllers).
- The scene recalled by the first button in a column is programmable, subsequent buttons recall the next numerical scene, and the last button always recalls Scene Off.
- A 1-button scene wallstation will always toggle between the assigned scene and Scene Off.

Scene (without OFF)

- Identical function to scene with Off, except the last button in a column recalls the next consecutive scene, not Scene Off.

Zone Toggle

- Buttons toggle a zone or group of zones between programmable preset values and Off (where all zones are Off).
- Each zone can be programmed to a different value.
- Each button can be individually programmed to a different zone or group of zones.

Partition

- Allows the user to assign individual buttons of a column to different scene controllers (areas).
- One button press (button LED lights) indicates an open partition within the space so that devices programmed to that button talk to each other in both directions.
- A second button press (button LED goes off) indicates a closed partition within the space so that devices programmed to that button function independently.

2B Partition (2-button wallstation only)

- Identical function to partition, except that there are two buttons.
- A top button press indicates an open partition; a bottom button press indicates a closed partition.

2B Fine Tune (2-button wallstation only)

- Buttons function as raise and lower buttons for assigned zones.
- A button tap will raise/lower the level of assigned zones by 1 percent.
- Pressing and holding the buttons smoothly raises to high end or smoothly lowers to low end.

2B Sequence (2-button wallstation only)

- All assigned scene controllers continuously cycle through either Scenes 1-4 or Scenes 5-16 using the programmed fade times for each scene.
- Useful for spaces that desire dynamic lighting, such as decorative lighting or displays in retail stores.

(continued on next page)

| | |
|--|-----------------------|
| <p>Job Name:</p> <p>Job Number:</p> | <p>Model Numbers:</p> |
|--|-----------------------|

Available Column Types (continued)

2B Panic (2-button wallstation only)

- Button press causes all assigned scene controllers go to Scene 16.
- Temporarily disables all button presses and ignores scene or zone level changes.

2B Timeclock (2-button wallstation only)

- Allows the user to enable or disable the timeclock on a GRAFIK Eye QS.
- A top button press enables the timeclock; a bottom button press disables the timeclock.

Shade

- Wallstation must have more than 1 button.
- Raise/Lower buttons are recommended for programming.
- The top button becomes the Open button; the bottom button becomes the Close button for associated Lutron Sivoia QS shades or third-party AC shades.
- For keypads with more than two buttons, the middle buttons are programmable preset buttons.

Shade Group

- Available only on a multi-column keypad where another column is a shade column.
- Allows the shade column to operate as multiple independent keypads (one per group).
- The shade group column selects which independent keypad is currently active (indicated by the group button whose LED is lit).

Note: Column types can be changed using the GRAFIK Eye QS programming menu (e.g., control programmed as lights only can be changed to shades only).

| | |
|--|-----------------------|
| <p>Job Name:</p> <p>Job Number:</p> | <p>Model Numbers:</p> |
|--|-----------------------|

Standard seeTouch QS Wallstation Button Functions Summary (WH Only)

| Button Configurations | | | |
|-----------------------|--------------------------------------|--|--|
| | | | |
| 2B | 3B | 5B | 7B |
| Lobby | | | |
| Engraving Codes | | | |
| A | L | L | L |
| All On ☀ All Off ☾ | All On ☀ Event All Off ☾ | All On ☀ Morning Afternoon Evening All Off ☾ | All On ☀ Morning Afternoon Evening After Hours Event All Off ☾ |
| Restaurant | | | |
| Engraving Codes | | | |
| A | R | R | R |
| All On ☀ All Off ☾ | All On ☀ After Hours All Off ☾ | All On ☀ Breakfast Lunch Dinner All Off ☾ | All On ☀ Breakfast Lunch Dinner After Hours Cleaning All Off ☾ |

| Button Configurations | | | |
|-----------------------|--------------------------------------|--|---|
| | | | |
| 2B | 3B | 5B | 7B |
| Retail | | | |
| Engraving Codes | | | |
| A | R | L | T |
| All On ☀ All Off ☾ | All On ☀ After Hours All Off ☾ | All On ☀ Morning Afternoon Evening All Off ☾ | All On ☀ Morning Afternoon Evening After Hours Cleaning All Off ☾ |
| Classroom | | | |
| Engraving Codes | | | |
| A | A | A | C |
| All On ☀ All Off ☾ | All On ☀ Present All Off ☾ | All On ☀ Present Lecture Exam All Off ☾ | All On ☀ Present Lecture Exam Movie Cleaning All Off ☾ |

| | |
|-------------|----------------|
| Job Name: | Model Numbers: |
| Job Number: | |

Standard seeTouch QS Wallstation Button Functions Summary (WH only) (continued)

| Button Configurations | | | | |
|--|-------------------|------------------------------|--|--|
| | | | | |
| 1B | 2B | 3B | 5B | 7B |
| Meeting Room | | | | |
| Engraving Codes | | | | |
| | A | M | M | M |
| N/A | All On All Off | All On Meeting All Off | All On Meeting A/V Cleaning All Off | All On Meeting A/V Pendant Perimeter Event All Off |
| Ballroom | | | | |
| Engraving Codes | | | | |
| | A | L | B | B |
| N/A | All On All Off | All On Event 1 All Off | All On Event 1 Event 2 Event 3 All Off | All On Event 1 Event 2 Event 3 Event 4 Event 5 All Off |
| Private Office | | | | |
| Engraving Codes | | | | |
| | A | P | P | N/A |
| N/A | All On All Off | On Dim Off | On Dim Zone 1 Zone 2 Off | |
| Zone Toggle | | | | |
| Engraving Code: Z for all configurations | | | | |
| On/Off | Zone 1 Zone 2 | Zone 1 Zone 2 Zone 3 | Zone 1 Zone 2 Zone 3 Zone 4 Zone 5 | Zone 1 Zone 2 Zone 3 Zone 4 Zone 5 Zone 6 Zone 7 |

| Button Configurations | | |
|--|--------------------------------|--|
| | | |
| 1RLD | 2RLD | 3BD |
| Shades – Dual Zone | | |
| Engraving Code: D for all configurations | | |
| N/A | Open Close | N/A |
| | Open Close | |
| Lights and Shades A | | |
| Engraving Code: U for all configurations | | |
| On Preset Off | On Off Open Close | On Preset Off Open Preset Close |
| Lights Dual Zone | | |
| Engraving Code: K for all configurations | | |
| N/A | On Off On Off | On Preset Off On Preset Off |
| Lights and Shades B | | |
| Engraving Code: Q for all configurations | | |
| N/A | N/A | On Preset Off Open Stop Close |

| | |
|--------------------|-----------------------|
| Job Name: | Model Numbers: |
| Job Number: | |

How to Build a Custom seeTouch QS Model Number

QSW S2 - -

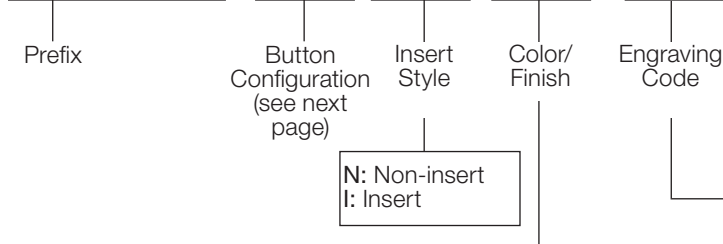

| Color/Finish Codes | |
|--|-----|
| Architectural Matte Finishes | |
| White | WH |
| Ivory | IV |
| Beige | BE |
| Gray | GR |
| Brown | BR |
| Black | BL |
| Almond | AL |
| Light Almond | LA |
| Taupe | TP |
| Architectural Metal Finishes | |
| With black plastic buttons (standard). | |
| Bright Brass | BB |
| Bright Chrome | BC |
| Bright Nickel | BN |
| Satin Brass | SB |
| Satin Chrome | SC |
| Satin Nickel | SN |
| Antique Brass | QB |
| Antique Bronze | QZ |
| Anodized Aluminum Finishes | |
| With black plastic buttons (standard). | |
| Clear | CLA |
| Black | BLA |
| Brass | BRA |
| Satin Colors Matte Finishes | |
| Available with Insert (I) style controls only. | |
| Snow | SW |
| Midnight | MN |
| Taupe | TP |
| Biscuit | BI |
| Eggshell | ES |
| Palladium | PD* |
| Hot | HT* |
| Merlot | MR* |
| Plum | PL* |
| Sienna | SI* |
| Terracotta | TC* |
| Bluestone | BG* |
| Green briar | GB* |
| Goldstone | QS* |
| Mocha stone | MS* |
| Stone | ST* |
| Desert Stone | DS* |
| Limestone | LS* |

***Note:** Some Satin Colors units ship with different color buttons. For more information, please visit the seeTouch website at www.lutron.com/seeTouch

***For the latest color offerings please see our website:** <http://www.lutron.com/satincolors>

| Engraving Codes |
|---|
| Omit: Unengraved |
| EGN: General Engraving For "Lights only" and "Lights and Shades" controls |
| E01: Standard Engraving For "Shades only" controls |
| E02: Secondary engraving for "Shades only" controls |
| NST: Non-Standard Text Engraving Please visit the GRAFIK Eye QS website at www.lutron.com/grafikeyeqs for custom engraving forms |

- Engraving Notes**
- The engraving option (model number and suffix) is related to the control type, as shown above in the "How to Build a Standard seeTouch QS Model Number" section.
 - Four engraving options are available:
 - EGN: General engraving for 'Lights Only' and 'Lights and Shades' controls
 - E01: Standard engraving for 'Shades Only' controls and 'Lights and Shades' for model QSWE-10BRLI-WH-E01 only
 - E02: Secondary engraving for 'Shades Only' controls
 - NST: Non-standard engraving for 'Lights Only', 'Lights and Shades', or 'Shades Only' controls
 - If no engraving is specified, wallstations will ship with an engraving certificate, with EGN being its default engraving type.

If no color is specified, wallstations will ship with white (WH) finish.

LUTRON SPECIFICATION SUBMITTAL Page

| | |
|--------------------|-----------------------|
| Job Name: | Model Numbers: |
| Job Number: | |

Custom seeTouch QS Wallstation Button Functions Summary

| Button Configuration | | | | | | | |
|---|--------------------|-----------------------------------|---|---|--|---|--|
| | | | | | | | |
| 1B | 2B | 3B | 5B | 7B | 1RLD | 2RLD | 3BD |
| EGN (General Engraving) Functionality | | | | | | | |
| Scene 1 | Scene 1 Off | Scene 1 Scene 2 Scene 3 | Scene 1 Scene 2 Scene 3 Scene 4 Off | Scene 1 Scene 2 Scene 3 Scene 4 Scene 5 Scene 6 Scene 7 | Scene 1 Scene 2 Scene 3 Open Close | Scene 1 Off Open Close | Scene 1 Scene 2 Scene 3 Open Preset Close |
| E01 (Standard Engraving) Functionality | | | | | | | |
| N/A | Open Close | Open Preset Close | Open Preset 1 Preset 2 Preset 3 Close | N/A | Group 1 Group 2 Group 3 Open Close | Open Close Open Close | Open Preset Close Open Preset Close |
| E02 (Secondary/Shades Only Engraving) Functionality | | | | | | | |
| N/A | N/A | N/A | N/A | N/A | Blackout Sheer Both Open Close | N/A | N/A |

Legend:
 Light Control
 Shade Control

How to Build a seeTouch QS Model Number

Button Configurations



1B
1-button

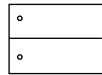

2B
2-button

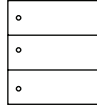

3B
3-button

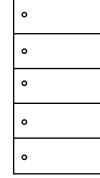

5B
5-button

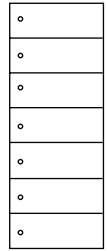

7B
7-button

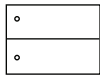

2BRL
2-button with
raise/lower

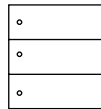

3BRL
3-button with
raise/lower

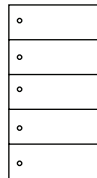

5BRL
5-button with
raise/lower

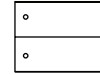

2BRLIR
2-button with IR
receiver and
raise/lower

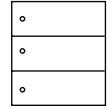

3BRLIR
3-button with IR
receiver and
raise/lower



2BRLIR
2-button with IR
receiver and
raise/lower



3BRLIR
3-button with IR
receiver and
raise/lower



5BRLIR
5-button with IR
receiver and
raise/lower



2BRLIR
2-button with IR
receiver and
raise/lower



3BRLIR
3-button with IR
receiver and
raise/lower

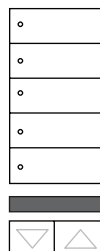

5BRLIR
5-button with IR
receiver and
raise/lower

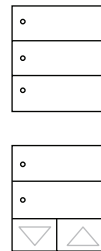

1RLD
Dual with 3-button
and 2-button with
raise/lower

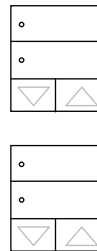

2RLD
Dual 2-button with
raise/lower

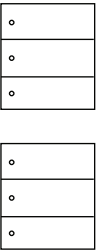

3BD
Dual 3-button

| | |
|--|-----------------------|
| <p>Job Name:</p> <p>Job Number:</p> | <p>Model Numbers:</p> |
|--|-----------------------|

Faceplate Information

Faceplate Replacement Kits

Use faceplate replacement kits to change: colors, button configuration, engraving, between insert and non-insert versions. Each kit includes an adapter, button assembly, and wallplate

Non-Insert Kit

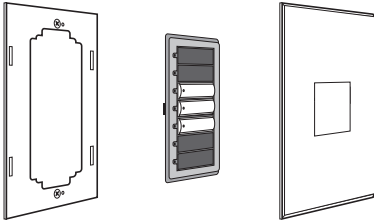

Non-insert style controls: Faceplate complements a specified button kit. When the faceplate is removed or replaced, the buttons are removed and replaced along with it.

Insert Kit

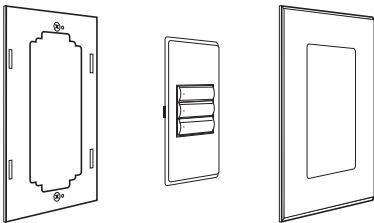

Insert style controls: Faceplate is a decorator style with a universal size opening that fits all button kits. This style allows for easy replacements of button kits without changing the faceplate.

Model Numbers for Kits

| Non-Insert | Insert |
|---------------|---------------|
| QSW2R-1BN | QSW2R-1BI |
| QSW2R-2BN | QSW2R-2BI |
| QSW2R-3BN | QSW2R-3BI |
| QSW2R-5BN | QSW2R-5BI |
| QSW2R-7BN | QSW2R-7BI |
| QSW2R-2BRLN | QSW2R-2BRLI |
| QSW2R-3BRLN | QSW2R-3BRLI |
| QSW2R-5BRLN | QSW2R-5BRLI |
| QSW2R-1RLDN | QSW2R-1RLDI |
| QSW2R-2RLDN | QSW2R-2RLDI |
| QSW2R-3BDN | QSW2R-3BDI |
| QSW2R-2BRLIRN | QSW2R-2BRLIRI |
| QSW2R-3BRLIRN | QSW2R-3BRLIRI |
| QSW2R-5BRLIRN | QSW2R-5BRLIRI |

| | |
|--------------------|-----------------------|
| Job Name: | Model Numbers: |
| Job Number: | |

Wallstation Installation

QS Link Wiring

- Use SELV/PELV/NEC® Class 2 wiring to connect wallstations to the QS Link.
- Connect two 22 AWG (0.5 mm²) shielded, twisted pair wires to terminals 3 and 4 of the wallstation's control link connector. Shielding (drain) of the twisted pair wires must be connected together as shown, but do not connect the shielding to earth/ground or the wallstation and do not allow it to contact the grounded wallbox.
- Connect the appropriate size wires to terminals 1 and 2 for power, according to your link length (see table below).
- Connect drain/shield as shown. Do not connect to ground (earth) or wallstation. Connect the bare drain wires and cut off the outside shield.

Note: Use appropriate wire connecting devices as specified by local codes.

Link Wiring (<500 ft/153 m)

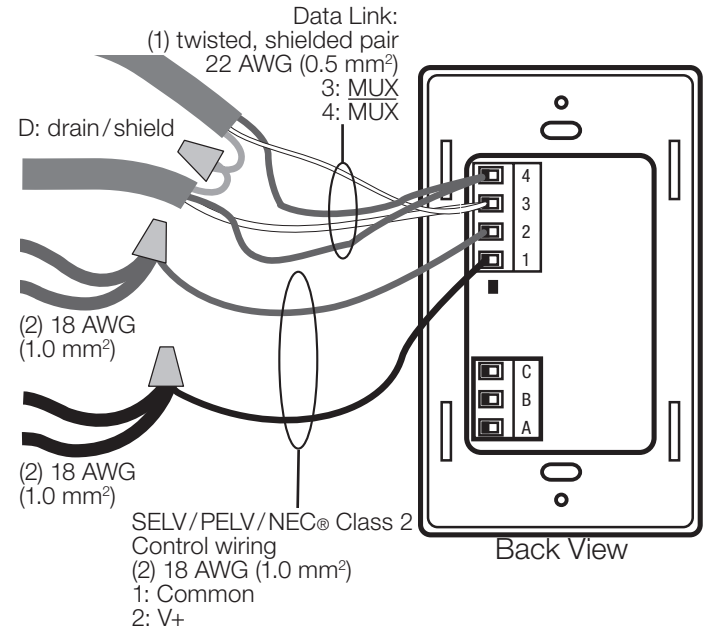

Link Wiring (500 ft/153 m to 2000 ft/610 m)

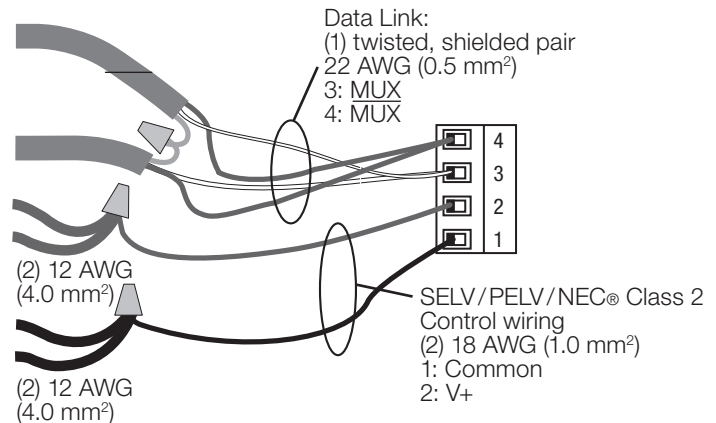

QS Link Wire Sizes (check compatibility in your area)

| QS Link Wiring Length | Wire Gauge | Lutron Cable Part Number |
|--------------------------------------|--|---|
| Less than 500 ft (153 m) | Power (terminals 1 and 2) 1 pair 18 AWG (1.0 mm ²) | GRX-CBL-346S (non-plenum) GRX-PCBL-346S (plenum) |
| | Data (terminals 3 and 4) 1 twisted, shielded pair 22 AWG (0.5 mm ²) | |
| 500ft to 2000 ft (153 m to 610 m) | Power (terminals 1 and 2) 1 pair 12 AWG (4.0 mm ²) | GRX-CBL-46L (non-plenum) GRX-PCBL-46L (plenum) |
| | Data (terminals 3 and 4) 1 twisted, shielded pair 22 AWG (0.5 mm ²) | |

| | |
|--------------------|-----------------------|
| Job Name: | Model Numbers: |
| Job Number: | |

Contact Closure Inputs

Specifications

- Inputs must be dry contact closure, solid-state, open collector, or active-low (NPN)/active-high (PNP) output.
 - Open collector NPN or active-low on-state voltage must be less than 2 V_{DC} and sink 3.0 mA
 - Open collector PNP or active-high on-state voltage must be greater than 12 V_{DC} and source 3.0 mA
- Wallstation is miswire protected up to 36 V_{DC}.
- Outputs must stay in the closed or open states for at least 40 msec in order to be recognized by the wallstation.

Contact Closure Input Wiring

- Use low-voltage SELV/PELV/NEC® Class 2 wiring to connect the contact closure inputs to the wallstation.

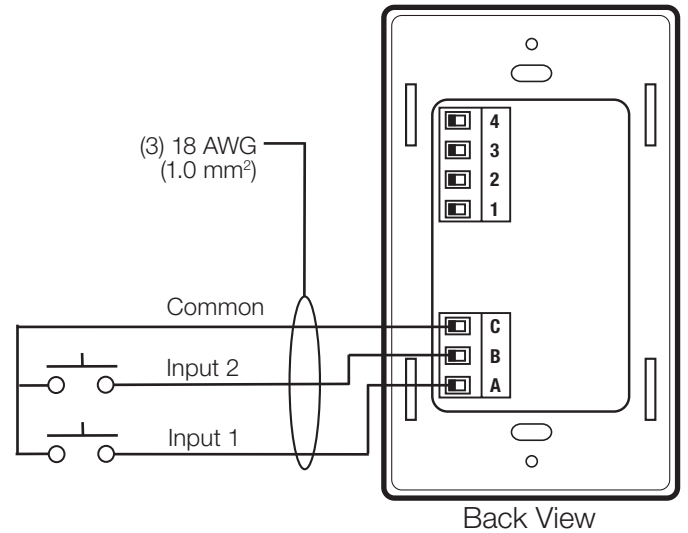

The Lutron logo, Lutron, GRAFIK Eye, Nova T₂, Quantum, Satin Colors, seeTouch, Sivoia, Energi Savr Node, and Vareo are trademarks or registered trademarks of Lutron Electronics Co., Inc. in the US and/or other countries.

All other product names, logos, and brands are property of their respective owners.

LUTRON SPECIFICATION SUBMITTAL

Page

| | |
|--------------------|-----------------------|
| Job Name: | Model Numbers: |
| Job Number: | |