

Nova T☆ Controls

This series of classic thin-profile linear-slide dimmers and switches offers the following standard features:

- Square Law Dimming
- Voltage compensation (not applicable to NTCL-250)
- Power-failure memory
- Superior RFI suppression
- Captive linear slider
- Accessible air-gap switch
- Electrostatic discharge tested
- Precise color matching
- Heavy-duty components for surge protection and long product life
- 100% factory tested

Product Family Features

- Available for 120–277 V~ line voltage switching (sink- only control) 0–10 V== LED drivers and ballasts (power pack not required for loads up to 8 A)
- Excellent for residential or commercial applications
- Intuitive operation; easy to use
- Slide-to-off and preset models available
- Enclosed heat sink for aesthetically pleasing appearance
- Multi-gang alignment for quick and easy installation
- Full family of products for most lighting sources, plus matching accessories and wallplates
- Rated at 120 V~ 60 Hz, unless noted otherwise
- Custom products (CPN) are available to meet specific customer needs. Please contact Lutron Customer Assistance at 1.844.LUTRON1 (588.7661) for availability.

Regulatory Approvals

- UL® Listed
- CSA certified
- NOM

Colors and Finishes

When ordering product for use with metal wallplates, the product and wallplate must be ordered separately. See the “Architectural Wallplates and Accessories” section of **Volume 1: Basic Devices and Single-Space Systems Catalog** (P/N 367-1746) for ordering procedure. See table to the right for complete list of metal finishes.

Custom color matching is available for all Nova T☆ products. A swatch or sample is all that is required. Call customer service to arrange for a color-matched control.



Slide-to-Off Controls
Select light level with slider; slide down to OFF



Preset Controls
Select light level with slider; press ON/OFF

Engraving is available for all Nova T☆ products. Engraving schedules are available at www.lutron.com/engraving or through Customer Assistance at 1.844.LUTRON1 (588.7661).

Available Colors and Finishes

Matte Finishes

To order, add color/finish suffix code to model number. Example: NT-600-**WH**

Code	Color
WH	White
TP	Taupe
AL	Almond
BL	Black

Code	Color
GR	Gray
IV	Ivory
LA	Light Almond

Code	Color
BE	Beige
SI	Sienna
BR	Brown

Special Order

To order, add color/finish suffix code to model number. Example: NT-600-**BB**

Metal Finishes

Code	Color
SB	Satin Brass
BC	Bright Chrome

Code	Color
BB	Bright Brass

Special Metal Finishes

Code	Color
QB	Antique Brass
SC	Satin Chrome
BN	Bright Nickel

Code	Color
QZ	Antique Bronze
SN	Satin Nickel

Anodized Aluminum Finishes

Code	Color
CLA	Clear

Code	Color
BLA	Black

Code	Color
BRA	Brass

Job Name:	Model Numbers:
Job Number:	

Dimensions

Measurements shown as: in (mm)

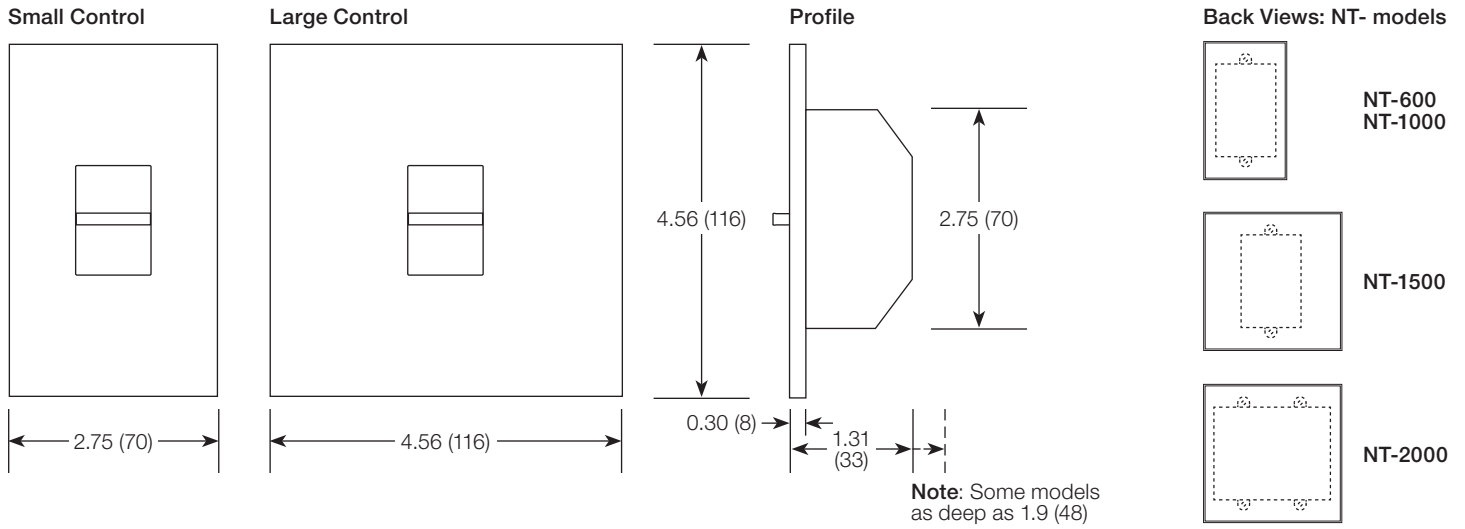

Available Controls and Accessories (Summary)

For specific uses, capacities, and model numbers, see the following pages.

Controls

Slide-to-Off Dimmers

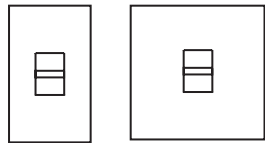

Small Control Large Control

Preset Dimmers

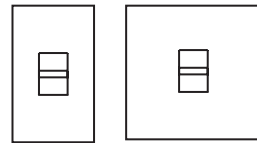

Small Control Large Control

Linear-Slide Switches

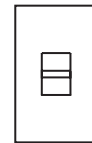

Small Control

Slide-to-Off Fan-Speed Controls

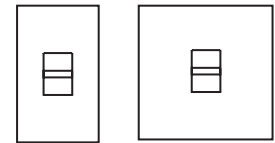



Small Control Large Control

Job Name:	Model Numbers:
Job Number:	



Control Specifications

Incandescent Dimmers: Slide-to-Off

	Description	Maximum Capacity	Model Number
 Small Control	Single-pole 120 V~ 60 Hz	600 W	NT-600-XX
	Single-pole 120 V~ 60 Hz	1000 W	NT-1000-XX
 Large Control	Single-pole 120 V~ 60 Hz	1500 W	NT-1500-XX
	Single-pole 120 V~ 60 Hz	1950 W	NT-2000-XX

- The NT-2000-XX does not have removable side sections; it can be ganged but must be kept intact.
- The NT-2000-XX requires a 2-gang wallbox.

Incandescent Dimmers: Preset

	Description	Maximum Capacity	Model Number
 Small Control	Single-pole/3-way/4-way 120 V~ 60 Hz	600 W	NT-603P-XX
	Single-pole/3-way/4-way 120 V~ 60 Hz	1000 W	NT-1003P-XX
 Large Control	Single-pole/3-way/4-way 120 V~ 60 Hz	1500 W	NT-1503P-XX

- For 3-way or 4-way switching, use NT-3PS-XX (3-way), NT-4PS-XX (4-way), or other mechanical switches.

C•L Dimmers: Slide-to-Off

	Description	Maximum Capacity	Model Number
 Small Control	Dimmable LED/CFL Single-pole 120 V~ 60 Hz	250 W	NTCL-250-XX
	Incandescent/Halogen Single-pole 120 V~ 60 Hz	1000 W	
	Hi-lume 1% 2-Wire LTE LED driver Single-pole 120 V~ 60 Hz	400 W (maximum of 10 drivers)	
	Mixed bulb type Single-pole 120 V~ 60 Hz	See Derating: Maximum Capacities in Multigang Installations	

Application requirements:

- When dimming LEDs or CFLs, **only** bulbs marked or rated as **dimmable** and on the recommended list may be used.
- For a complete list of recommended **dimmable** LEDs and CFLs please visit www.lutron.com/dimcflled. For questions call 1.844.LUTRON1.
- Some dimmable LEDs and CFLs require a minimum number of bulbs for proper operation. For details and the bulb list, visit www.lutron.com/dimcflled
- For LED product selection tool, visit www.lutron.com/ledtool

Features:

- Low-end adjustment to accommodate a wide range of bulbs.
- HEDT Technology: Advanced Lutron dimming circuitry designed for compatibility with most high efficacy light bulbs.
- NEMA SSL-7A Type 2 compliant.

Electronic Low-Voltage (ELV) Dimmers: Slide-to-Off











	Description	Maximum Capacity	Model Number
 Small Control	Single-pole 120 V~ 60 Hz	300 W	NTELV-300-XX
	Single-pole 120 V~ 60 Hz	600 W	NTELV-600-XX

- Maximum capacity is permitted lamp wattage.
- Requires neutral wire connection.
- For larger capacity ELV loads (up to 1000 W), use Nova T☆ fluorescent dimmers (NTF-10-XX or NTF-103P-XX) with a PHPM-WBX interface.
- Minimum Load: 5 W Incandescent/Halogen or 1 ELV transformer. ELV transformer must be loaded per manufacturer's recommendations.

(continued on next page...)

Job Name:	Model Numbers:
Job Number:	



Control Specifications (continued)

 Magnetic Low-Voltage (MLV) Dimmers: Slide-to-Off			
 Small Control	Description	Maximum Capacity	Model Number
	Single-pole 120 V~ 60 Hz	600 VA / 450 W	NTLV-600-XX
	Single-pole 277 V~ 60 Hz	600 VA / 450 W	NTLV-600-277-XX
	Single-pole 120 V~ 60 Hz	1000 VA / 800 W	NTLV-1000-XX
	Single-pole 277 V~ 60 Hz	1000 VA / 800 W	NTLV-1000-277-XX
 Large Control	Single-pole 120 V~ 60 Hz	1500 VA / 1200 W	NTLV-1500-XX
<ul style="list-style-type: none"> • Maximum capacity is permitted lamp wattage. • 277 V~ models require neutral wire connection. 			
 Magnetic Low-Voltage (MLV) Dimmers: Preset			
 Small Control	Description	Maximum Capacity	Model Number
	Single-pole/3-way/4-way 120 V~ 60 Hz	600 VA / 450 W	NTLV-603P-XX
	Single-pole/3-way/4-way 120 V~ 60 Hz	1000 VA / 800 W	NTLV-1003P-XX
 Large Control	Single-pole/3-way/4-way 120 V~ 60 Hz	1500 VA / 1200 W	NTLV-1503P-XX
<ul style="list-style-type: none"> • For 3-way or 4-way switching, use NT-3PS-XX (3-way), NT-4PS-XX (4-way), or other mechanical switches. 			
 Fluorescent Dimmers for Lutron 3-wire fluorescent ballasts or LED drivers: Slide-to-Off			
 Small Control	Description	Maximum Capacity	Model Number
	Single-pole 120 V~ 60 Hz	16 A	NTF-10-XX
	Single-pole 277 V~ 60 Hz	8 A	NTF-10-277-XX
<ul style="list-style-type: none"> • Use with Lutron 3-wire fluorescent ballasts or LED drivers only. • For LED loads, please see the "Report Cards" at www.lutron.com/ledtool for proper loading of the dimmer. • No derating required. • To determine the number of ballasts that can be controlled by Nova T☆ fluorescent dimmer, divide the control capacity by the ballast current. 			
 Fluorescent Dimmers for Lutron 3-wire fluorescent ballasts or LED Drivers: Preset			
 Small Control	Description	Maximum Capacity	Model Number
	Single-pole/3-way 120 V~ 60 Hz	8 A	NTF-103P-XX
	Single-pole/3-way 277 V~ 60 Hz	6 A	NTF-103P-277-XX
<ul style="list-style-type: none"> • Use with Lutron 3-wire fluorescent ballasts or LED drivers only. • For LED loads, please see the "Report Cards" at www.lutron.com/ledtool for proper loading of the dimmer. • For 3-way or 4-way switching, use NT-3PS-XX (3-way), NT-4PS-XX (4-way), or other mechanical switches. No derating required. • To determine the number of ballasts that can be controlled by Nova T☆ fluorescent dimmer, divide the control capacity by the ballast current. 			

(continued on next page...)

Job Name:	Model Numbers:
Job Number:	



Control Specifications (continued)

 Reverse-Phase Electronic Low-Voltage (ELV) Dimmer: Slide-to-Off			
 Small Control	Description	Maximum Capacity	Model Number
	Dimmable LED/CFL; Single-pole 120 V~ 60 Hz	250 W	NTRP-250-XX
	Incandescent/Halogen Single-pole 120 V~ 60 Hz	600 W	
	ELV with Halogen Single-pole 120 V~ 60 Hz	600 W	



• **For the best performance, use a bulb that is on the Lutron LED Report Card Tool at www.lutron.com/ledtool For questions call 1.877.DIM.LEDS.**
 • When dimming LEDs or CFLs, only bulbs marked or rated as DIMMABLE WITH REVERSE-PHASE OR UNIVERSAL DIMMERS may be used.
 • For recommended ELV transformers and compatible MR16 LED bulbs, please see Lutron Application Note #559 at www.lutron.com/TechnicalDocumentLibrary/048559.pdf. Always follow the transformer and bulb manufacturer instructions for allowable loading.
 • Not compatible with magentic low-voltage (MLV) transformers or magnetic LED transformers/drivers
 • Dimmer is not compatible with bulbs rated only for forward-phase type dimmers.
 • Minimum Load: 1 compatible CFL / LED bulb or 5 W Incandescent / Halogen or 1 ELV transformer. ELV transformer must be loaded per the manufacturer's recommendation.

0–10 V ^{DC} Dimmers for Electronic Ballasts or LED Drivers: Slide-to-Off				
 Small Control	Description	Maximum Capacity*		Model Number
		Load	0–10 V ^{DC} Sink	
	Single-pole 0–10 V ^{DC} 120–277 V~	8 A	30 mA	NTSTV-DV-XX

• Power pack not required for loads up to 8 A. May use Lutron power pack (model PP-DV or PP347H; see Lutron P/N 369544) for higher load current applications or for Class 2 installations.
 • Works with all ballasts and drivers that provide a current source compliant to IEC 60629 Annex E.2, and whose inrush current does not exceed NEMA410 standards for electronic ballast/driver loads of 8 A steady-state current. Refer to LED driver and ballast manufacturer's specification for 0–10 V^{DC} sink currents.
 • Control has a high and low end trim to adjust the 0–10 V^{DC} output for optimal dimming performance.
 * Limited by whichever rating is achieved first.

 Fluorescent Dimmers for Tu-Wire Electronic Ballasts: Slide-to-Off			
 Small Control	Description	Maximum Capacity	Model Number
	Single-pole 120 V~ 60 Hz	5 A	NTFTU-5A-XX
	Single-pole 277 V~ 60 Hz	5 A	NTFTU-5A-277-XX

• Use with Lutron Tu-Wire line voltage control electronic dimming ballasts only.
 • To determine the number of ballasts that can be controlled by Nova T☆ fluorescent dimmer, divide the control capacity by the ballast current.
 • Compatible with Advance® Mark X® and Sylvania Powersense® ballasts.

 Fluorescent Dimmers for Advance® Mark X® VEZ series 277 V~ Ballasts: Preset			
 Small Control	Description	Maximum Capacity	Model Number
	3-way 277 V~ 60 Hz	3 A	NTFTU-103P-277-XX-CPW0196

• For control of permanently installed Advance® Mark X® VEZ series 277 V~ ballasts only.
 • Install on load side only.
 • No derating required.
 • To determine the number of ballasts that can be controlled by Nova T☆ fluorescent dimmer, divide the control capacity by the ballast current.





Linear-Slide Switches for General Purpose: All Sources and Motor Loads			
 Small Control	Description	Maximum Capacity	Model Number
	Single-pole 120/277 V~ 60 Hz	20 A	NT-1PS-XX
	3-way 120/277 V~ 60 Hz	20 A	NT-3PS-XX
	4-way 120/277 V~ 60 Hz	20 A	NT-4PS-XX

• No derating required.

(continued on next page...)

Job Name:	Model Numbers:
Job Number:	

Control Specifications (continued)

Low-voltage Momentary Switch			
 Small Control	Description	Maximum Capacity	Model Number
	Up to 10 switches per power pack, 24 V $\overline{\text{---}}$ /24 V \sim 60 Hz	1 A	NTRCS-1-XX
<ul style="list-style-type: none"> • For use with Lutron devices (power pack and wired occupancy sensors) only. • No derating required. • Not available in AL, LA, or SI. 			
✂ Fan-Speed Controls: Quiet			
 Small Control	Description	Maximum Capacity	Model Number
	Single-pole, 3-speed 120 V \sim 60 Hz	1.5 A	NTFSQ-XX
<ul style="list-style-type: none"> • For use with one ceiling paddle fan. • No derating required. 			
⚙ Fan-Speed Controls: Fully Variable			
 Small Control	Description	Maximum Capacity	Model Number
	Single-pole, Adjustable minimum speed 120 V \sim 60 Hz	6 A	NTFS-6E-XX
 Large Control	Description	Maximum Capacity	Model Number
	Single-pole, Adjustable minimum speed 120 V \sim 60 Hz	12 A	NTFS-12E-XX
<ul style="list-style-type: none"> • For use with one or more ceiling, ventilation, or exhaust fans. Do not mix fan types on same control. 			

Job Name:	Model Numbers:
Job Number:	

Derating: Maximum Capacities in Multigang Installations*

When installing more than one dimmer in the same wallbox, it may be necessary to remove some side sections prior to wiring (see diagram below). Removal of side sections may reduce maximum wattage, as shown in the charts below.

Mixing bulb types (using a combination of LED/CFL and incandescent/halogen bulbs) will also affect the maximum ratings, as shown in the charts below.

Example: If one set of side sections is removed and you have eight 9 W LED bulbs installed (Total LED Wattage = 72 W), you may add up to 500 W of incandescent or halogen lighting with the C•L control or 300 W with the Reverse-Phase control.

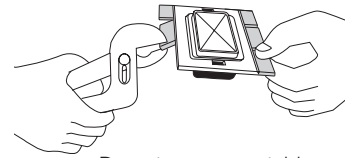

Do not remove outside sections (shaded areas below)

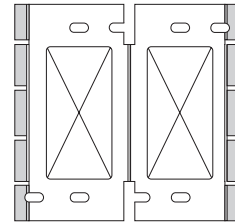

Each control has inside sections removed

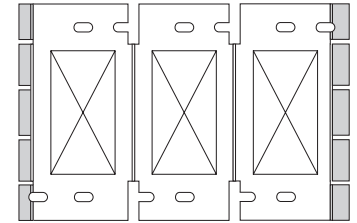

Middle control has two side sections removed

Single Units Full capacity. No side sections removed	End Units One side section removed	Middle Units Two side sections removed
Incandescent Controls		
600 W	500 W	300 W
1000 W	900 W	700 W
1500 W	1250 W	1000 W
1950 W	—	—
• NT-2000-XX controls (for 1950 W capacity) must be ganged without removing side sections.		

C•L Controls			
Maximum Allowable Incandescent/Halogen Wattage			+ Total LED/CFL Wattage Installed (Wattage per bulb × number of bulbs)
1000 W	800 W	600 W	+ 0 W
800 W	600 W	500 W	+ 1 W – 40 W
600 W	500 W	400 W	+ 41 W – 80 W
500 W	400 W	300 W	+ 81 W – 120 W
400 W	300 W	200 W	+ 121 W – 160 W
300 W	200 W	100 W	+ 161 W – 200 W
0 W	0 W	0 W	+ 201 W – 250 W
• No derating is required for multigang installations if only LED bulbs are used or if no fins are broken.			

Reverse-Phase Electronic Low-Voltage (ELV) Controls			
Maximum Allowable Incandescent/Halogen Wattage			+ Total LED/CFL Wattage Installed (Wattage per bulb × number of bulbs)
600 W	500 W	400 W	+ 0 W
500 W	400 W	300 W	+ 1 W – 40 W
400 W	300 W	200 W	+ 41 W – 80 W
300 W	200 W	100 W	+ 81 W – 120 W
200 W	100 W	50 W	+ 121 W – 160 W
100 W	50 W	0 W	+ 161 W – 200 W
0 W	0 W	0 W	+ 201 W – 250 W
• No derating is required for multigang installations if only LED bulbs are used or if no fins are broken.			

* For more information on multigang installations, visit www.lutron.com/en-US/Service-Support/Pages/Technical/InstallationInstructions/Ganging-Derating/GangingDerating.aspx

(continued on next page...)

Job Name:	Model Numbers:
Job Number:	

Derating: Maximum Capacities in Multigang Installations* (continued)

<i>Single Units</i> Full capacity. No side sections removed		<i>End Units</i> One side section removed		<i>Middle Units</i> Two side sections removed	
Electronic Low-Voltage (ELV) Controls					
300 W		300 W		250 W	
600 W		500 W		400 W	
• Permitted lamp wattage for ELV controls.					
Magnetic Low-Voltage (MLV) Controls					
600 VA/450 W		500 VA/400 W		300 VA / 250 W	
1000 VA/800 W		900 VA/750 W		700 VA / 500 W	
1500 VA/1200 W		1250 VA/1000 W		1000 VA / 800 W	
• Permitted lamp wattage for MLV controls.					
Fluorescent 3-Wire Ballast or LED Driver Controls					
6 A		No derating required			
8 A		No derating required			
16 A		No derating required			
Fluorescent Tu-Wire Controls					
3 A		No derating required			
5 A		4 A		3.3 A	
0-10 V⁼⁼ Electronic Ballast or LED Driver Controls					
<i>Load</i>	<i>0-10 V⁼⁼ Sink</i>	No derating required			
8 A	30 mA				
Quiet Fan-Speed Controls					
1.5 A		No derating required			
Fully Variable Fan-Speed Controls					
6 A		4.2 A		2.5 A	
12 A		10 A		8.3 A	

* For more information on multigang installations, visit www.lutron.com/en-US/Service-Support/Pages/Technical/InstallationInstructions/Ganging-Derating/GangingDerating.aspx

Job Name:	Model Numbers:
Job Number:	

Wiring Diagrams: Single Location

Single-Pole Control

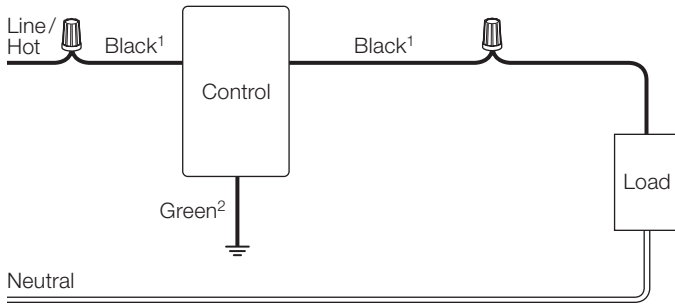

Models:

- NT-600-XX
- NT-1000-XX
- NT-1500-XX
- NT-2000-XX
- NTCL-250-XX
- NTLV-600-XX
- NTLV-1000-XX
- NTLV-1500-XX
- NT-1PS-XX
- NTFSQ-XX

Key

- Ground
- Wire connector
- ¹ Wire or brass/gold screw terminal*
- ² Wire or green screw terminal*
- ³ Wire or copper/black screw terminal*
- * Dimmers have wires; switches have screw terminals

3-Way Control

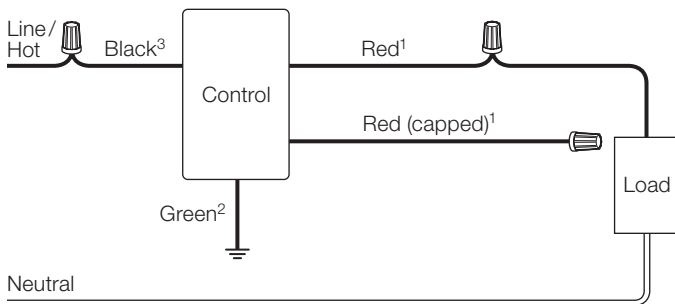

Models:

- NT-603P-XX
- NT-1003P-XX
- NT-1503P-XX
- NTLV-603P-XX
- NTLV-1003P-XX
- NTLV-1503P-XX
- NT-3PS-XX

Fan Control

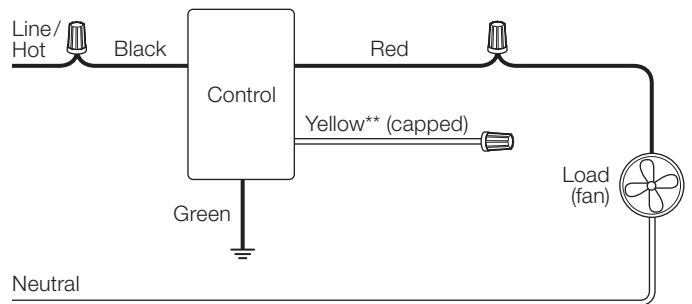

Models:

- NTFS-6E-XX
- NTFS-12E-XX

** Switched full-voltage only

Single-Pole Control with Neutral

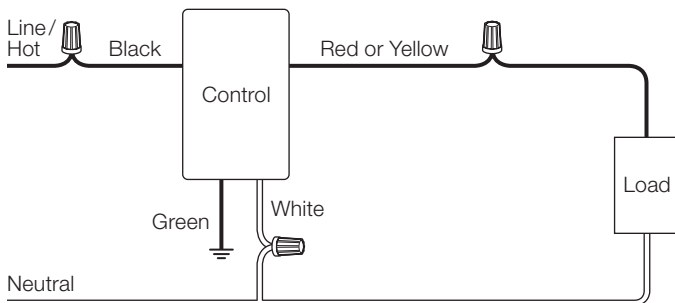

Models:

- NTELV-300-XX**
- NTELV-600-XX**
- NTLV-600-277-XX
- NTLV-1000-277-XX
- NTRP-250-XX

** Use NTELV- models with 120 V~ only

Fan/Light Control

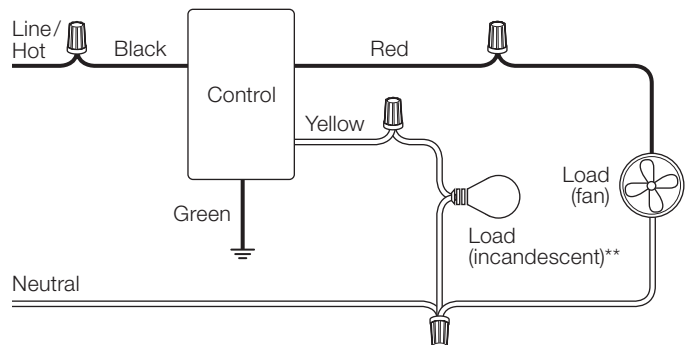

Models:

- NTFS-6E-XX
- NTFS-12E-XX

** Switched full-voltage only

Job Name:	Model Numbers:
Job Number:	

Wiring Diagrams: Multi-Location

3-Way Control

Line Side

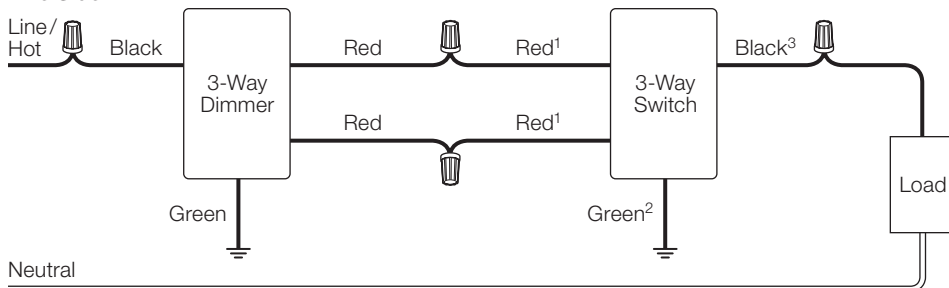

Load Side

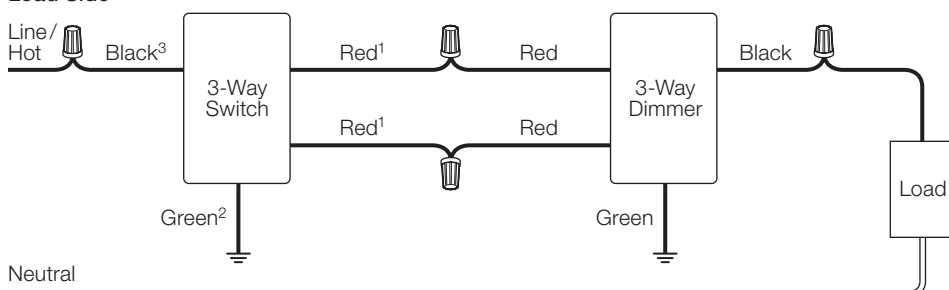

Key

- Ground
- Wire connector
- ¹ Wire or brass/gold screw terminal*
- ² Wire or green screw terminal*
- ³ Wire or copper/black screw terminal*
- * Dimmers have wires; switches have screw terminals

Models:

- NT-603P-XX
- NTLV-603P-XX
- NT-3PS-XX
- NT-1003P-XX
- NTLV-1003P-XX
- NT-1503P-XX
- NTLV-1503P-XX

4-Way Control

Line Side

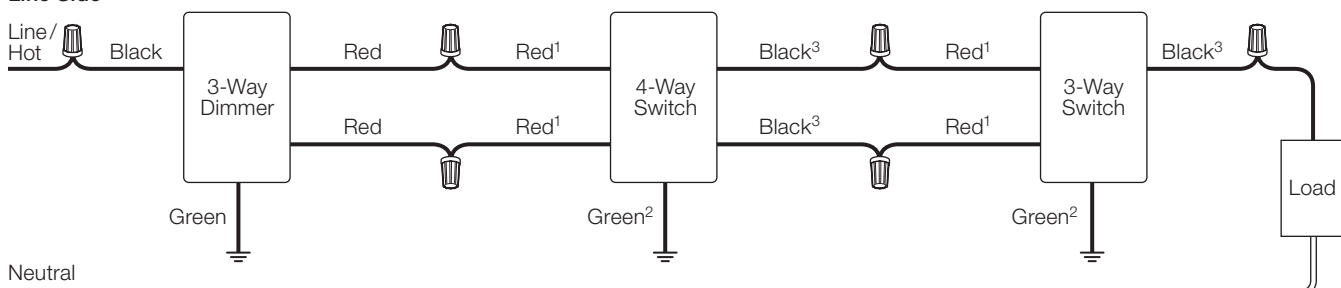

Load Side

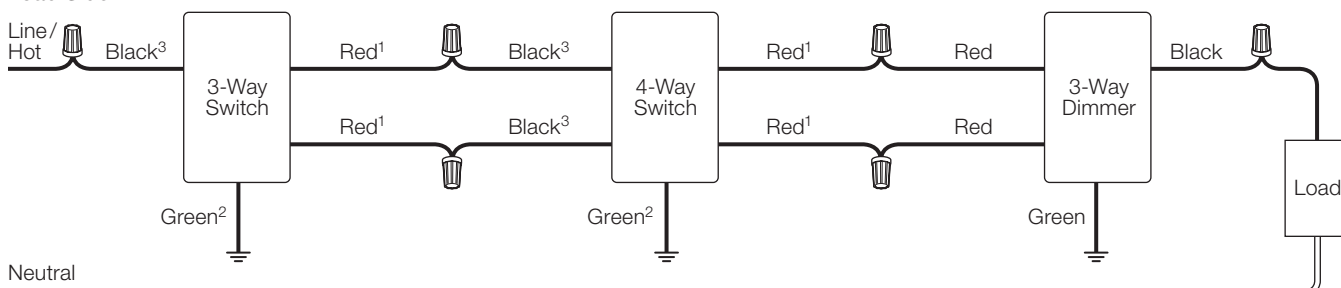

Models:

- NT-603P-XX
- NTLV-603P-XX
- NT-3PS-XX
- NT-1003P-XX
- NTLV-1003P-XX
- NT-4PS-XX
- NT-1503P-XX
- NTLV-1503P-XX

Job Name:	Model Numbers:
Job Number:	

Wiring Diagrams: NTF- Controls

Single-Pole Control

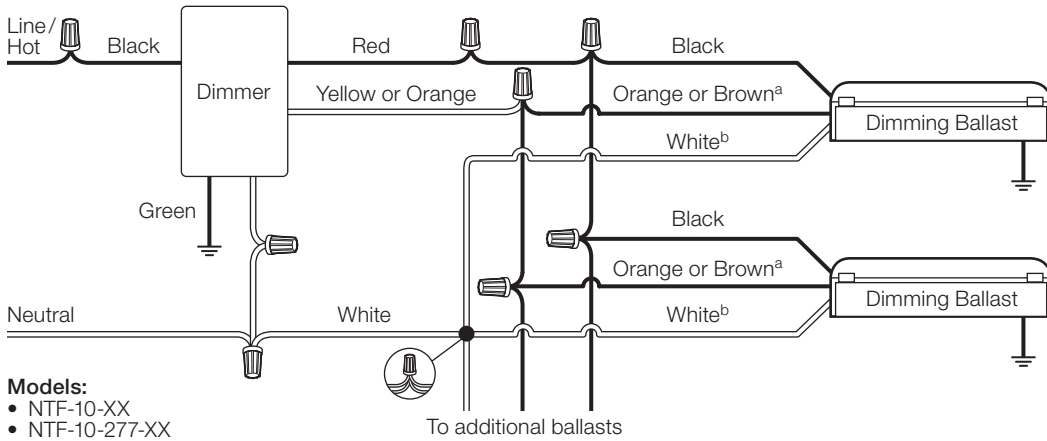

- Models:**
- NTF-10-XX
 - NTF-10-277-XX

Key

- Ground
- Wire connector
- Typical 4-wire connection

^a Yellow/Blue or Yellow/Green wire when used with magnetic dimming ballasts

^b Must use lamp disconnect sockets with magnetic dimming ballasts

¹ Wire or brass/gold screw terminal*

² Wire or green screw terminal*

³ Wire or copper/black screw terminal*

* Dimmers have wires; switches have screw terminals

3-Way Control

Single-Pole

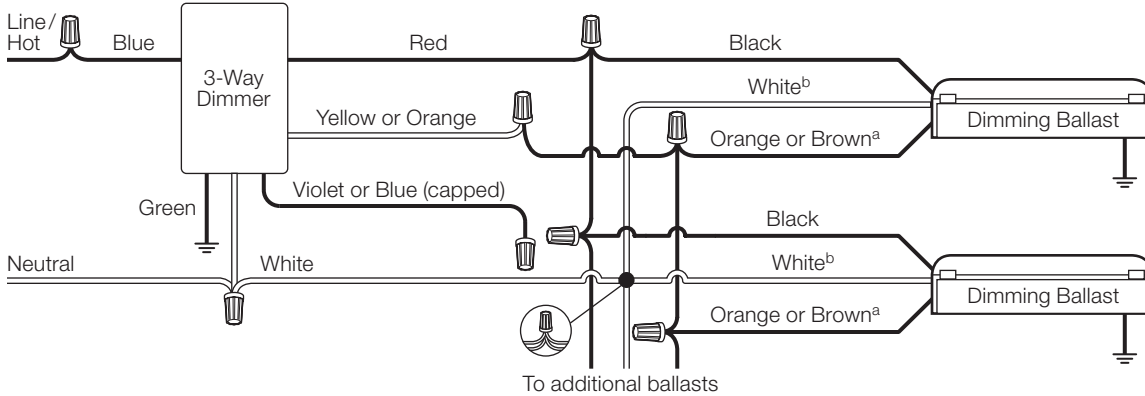

Load Side

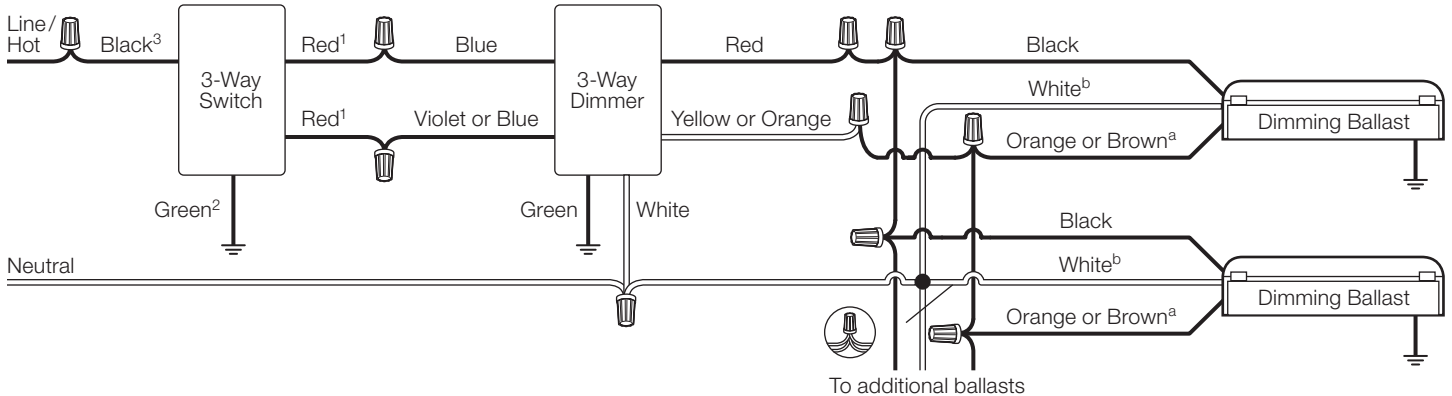

- Models:**
- NTF-103P-XX
 - NTF-103P-277-XX

Job Name:	Model Numbers:
Job Number:	

Wiring Diagrams: NTFTU- Controls

Single-Pole Control

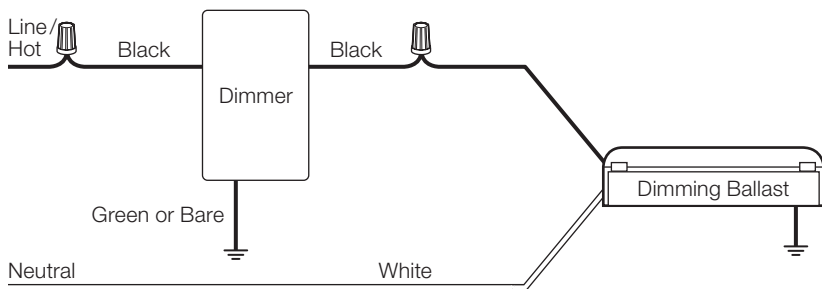

Model:
• NTFTU-5A-XX

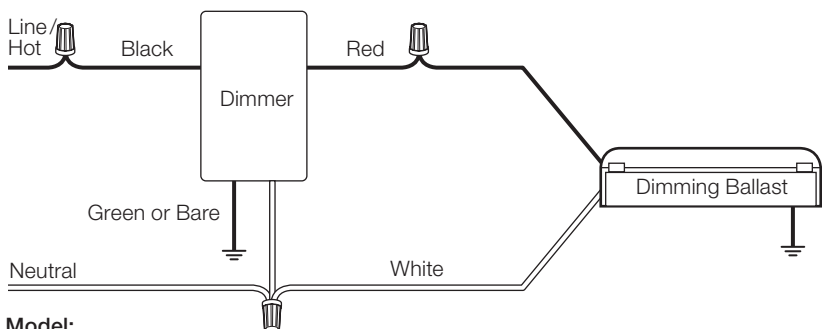

Model:
• NTFTU-5A-277-XX

Key

- Ground
- Wire connector
- ¹ Wire or brass/gold screw terminal*
- ² Wire or green screw terminal*
- ³ Wire or copper/black screw terminal*
- * Dimmers have wires; switches have screw terminals

3-Way Control

Single-Pole

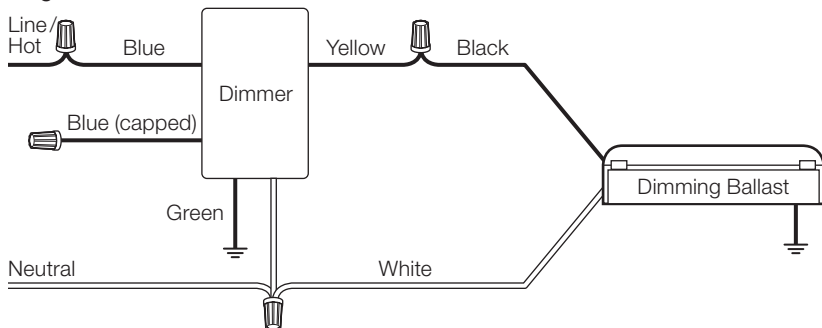

Load Side

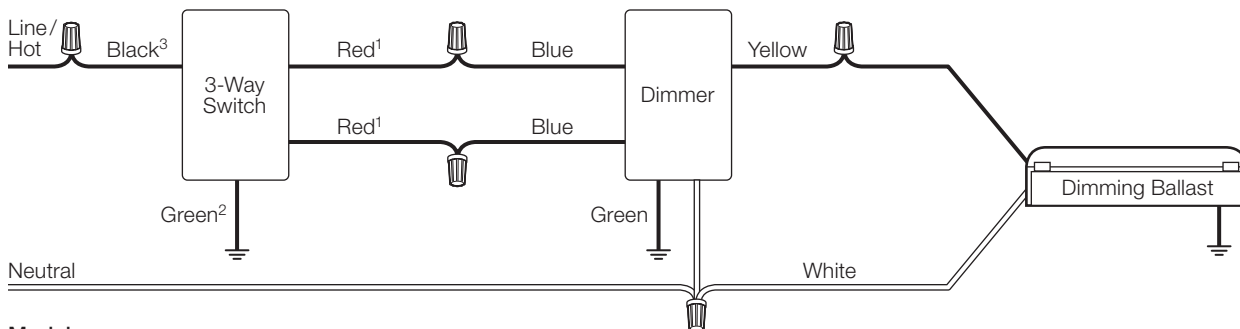

Model:
• NTFTU-103P-277-XX-CPW0196

Job Name:	Model Numbers:
Job Number:	

Wiring Diagrams: NTSTV- Controls

- The total 0–10 V_{DC} control signal wiring for this control should not exceed 500 ft (152.4 m).
- Do not use wire smaller than 20 AWG (0.75 mm²).
- For Class 1 installations, 0–10 V_{DC} wires must be run in conduit or approved cable per NEC® or local jurisdiction.
- For Class 2 installations, conduit is typically not required (local code may apply).
- For application with excessive electrical noise, 0–10 V_{DC} wires should be run in separate conduit from the mains.

Class 1 Installation

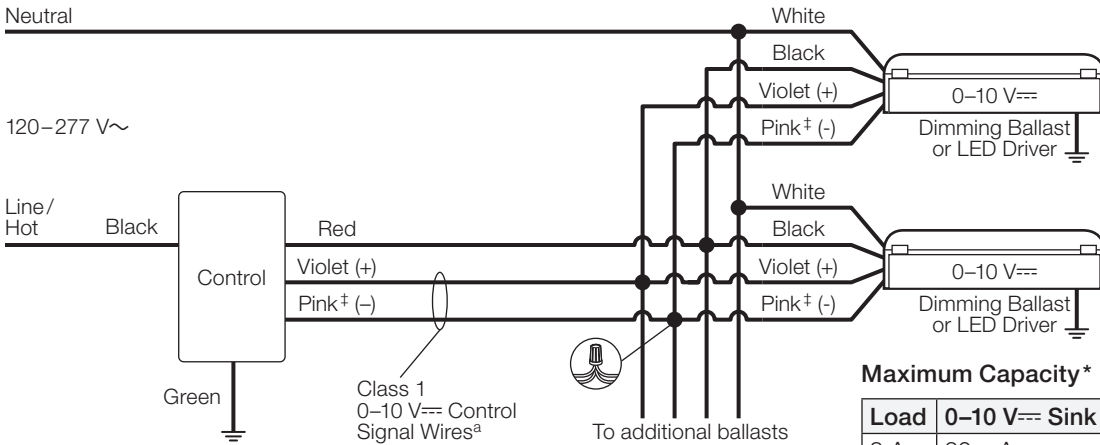

Model:
• NTSTV-DV-XX

Maximum Capacity*

Load	0–10 V _{DC} Sink
8 A	30 mA

* Whichever comes first.

Key

- Ground
- Wire connector
- Wire connector
- Typical 4-wire connection

^a Do NOT connect to line voltage

^b 18 AWG (1.0 mm²) red wires are interchangeable. Connect to either line or load side

^c Green wire may be capped for Class 2 installations ONLY

Class 2 Installation

ON/OFF control using Power Pack (PP-DV or PP-347H)

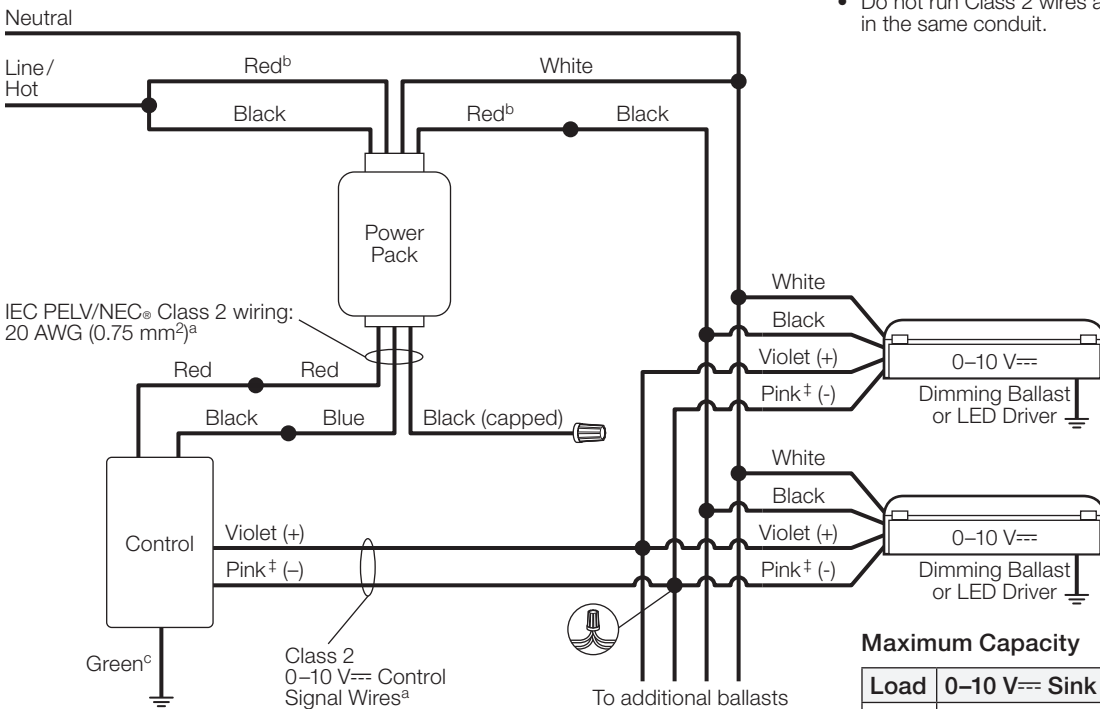

Model:
• NTSTV-DV-XX

Maximum Capacity

Load	0–10 V _{DC} Sink
**	30 mA

** See PP- and UPP-Series Power Packs spec submittal, Lutron P/N 369544

[†] This wire/terminal may be gray on older products or in retrofit applications.

Job Name:	Model Numbers:
Job Number:	

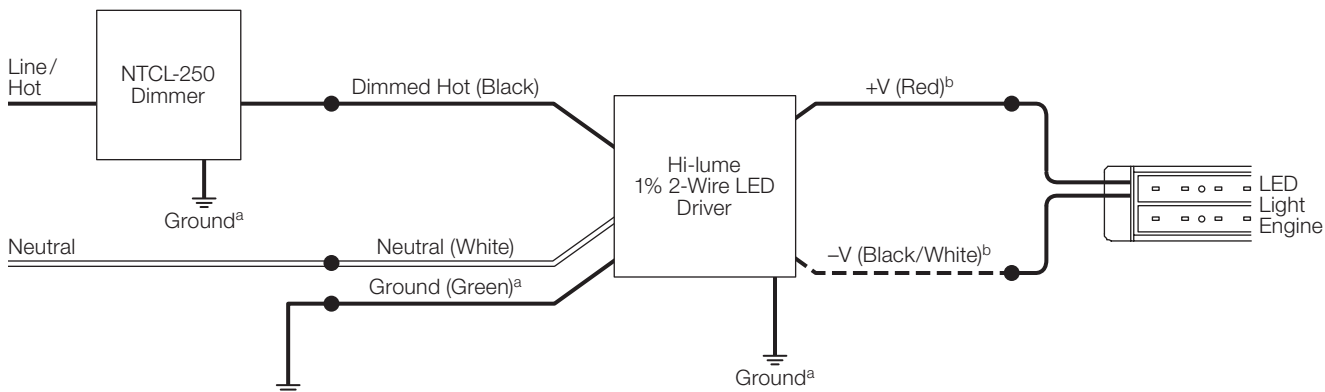

Wiring Diagrams: NTCL- Controls

Hi-lume 1% 2-Wire LTE LED Driver Installation



Model:
• NTCL-250-XX

Key

-  Ground
-  Wire connector

^a Enclosure and junction box must be grounded in accordance with local and national electrical codes. Ground provided by grounding of junction box or by using the green ground wire connection

^b For maximum driver-to-LED light engine wire length, see **Hi-lume 1% 2-Wire LED Driver (P/N 369543)**

The Lutron logo, Lutron, C•L, Hi-lume, Nova T☆, and Tu-Wire are trademarks or registered trademarks of Lutron Electronics Co., Inc. in the US and/or other countries. All other product names, logos, and brands are property of their respective owners.

LUTRON SPECIFICATION SUBMITTAL		Page
Job Name:	Model Numbers:	
Job Number:		