

## Maestro RF 0–10 V Sensor Dimmer/RF Sensor Switch

Lutron Maestro RF 0–10 V Sensor Dimmers/RF Sensor Switches are lighting controls with passive infrared sensors that automatically control the lights in an area. These sensors detect heat from occupants moving within an area to determine when the space is occupied.

Features Lutron Clear Connect RF technology, which enables wireless communication with Radio Powr Savr sensors and Pico remote controls for light control and general switched loads.

These products are also compatible with the Vive hub which enables a simple setup process using a standard web browser on any Wi-Fi enabled phone, tablet or computer. It also enables control and monitoring of all Vive devices. The Vive hub can be added at any time, however system reprogramming will be required. For a complete list of features supported with the Vive hub, see specification submittal 369902 at [www.lutron.com](http://www.lutron.com)

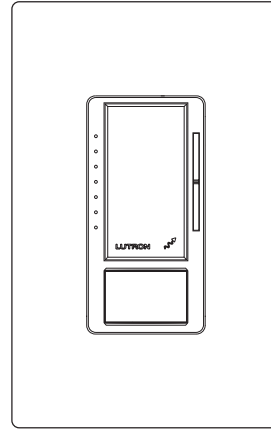

Dimmer

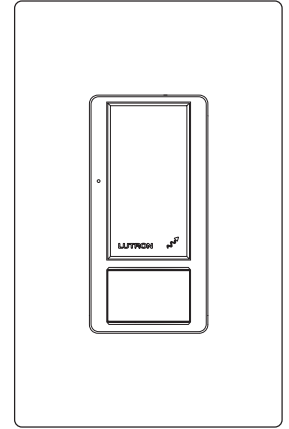

Switch

### Features

- Controls 0–10 V<sub>AC</sub> electronic fluorescent ballasts or LED driver load types<sup>1</sup>
- Passive infrared motion detection with exclusive Lutron XCT Technology for fine motion detection
- 180° sensor field-of-view
- Up to 30 ft × 30 ft (9 m × 9 m) [900 ft<sup>2</sup> (81 m<sup>2</sup>)] major motion coverage and 20 ft × 20 ft (6 m × 6 m) [400 ft<sup>2</sup> (36 m<sup>2</sup>)] minor motion coverage
- Occupancy version can be set to auto-on/auto-off or manual-on/auto-off
- Adjustable timeout (1, 5, 15, or 30 minutes)
- Adjustable settings for auto-on light level (occupancy level): Fully adjustable from 1%–100%
- Adjustable settings for auto-off light level (vacancy level): Fully adjustable from 0%–100%
- Adjustable sensitivity level: High, Med, Low, Min
- Off warning fades lights to off over a period of 10 seconds<sup>1</sup>
- Adaptive switching algorithm for extended relay life
- Smart ambient light detection (ALD)
- Works with up to 10 Pico remote controls, 1 Radio Powr Savr daylight sensor, and 10 Radio Powr Savr PIR sensors
- High-end trim and low-end trim to adjust maximum and minimum light levels
- Uses Lutron’s “Off While Occupied” feature<sup>2</sup>

**Note:** This product requires a neutral wire connection to function.

<sup>1</sup> Only available with the sensor dimmer. Not available with the sensor switch.  
<sup>2</sup> For more information visit: [www.lutron.com/TechnicalDocumentLibrary/048687.pdf](http://www.lutron.com/TechnicalDocumentLibrary/048687.pdf)

<b>Job Name:</b>	<b>Model Numbers:</b>
<b>Job Number:</b>	

## Models Available

Model Number	Description	Sensor Operation	Load Types
MRF2S-8SD010-XX <sup>1</sup>	Occupancy/vacancy single-pole/multi-location sensor dimmer	Auto-On/Auto-Off or Manual-On/Auto-Off	For use with permanently installed electronic fluorescent ballast or LED driver lighting loads
MRF2S-8SS-XX <sup>1</sup>	Occupancy/vacancy single-pole/multi-location sensor switch	Auto-On/Auto-Off or Manual-On/Auto-Off	For use with all lighting loads and fan loads up to 4.4 A
MRF2S-8SDV010-XX <sup>1</sup>	Vacancy single-pole/multi-location sensor dimmer	Manual-On/Auto-Off	For use with permanently installed electronic fluorescent ballast or LED driver lighting loads
MRF2S-8SSV-XX <sup>1</sup>	Vacancy single-pole/multi-location sensor switch	Manual-On/Auto-Off	For use with all lighting loads and fan loads up to 4.4 A

<sup>1</sup> XX in model number represents color/finish code. See **Colors and Finishes** on page 10.

### Notes:

- Neutral is required for product to function. If a neutral wire is not present, consult a licensed electrician.
- When power is applied, the sensor dimmer/switch can be manually turned on or off after the first 10 seconds and will automatically control the load after 2 minutes.
- The sensor dimmer works with all ballasts and drivers that provide a current source compliant to IEC 60929 Annex E.2.
- The 0–10 V $\overline{=}$  control wires are not to exceed 250 ft (76.2 m) in length, and must have a size of no less than 20 AWG (0.75 mm<sup>2</sup>).
- The 0–10 V $\overline{=}$  wires may be installed as Class 1 or Class 2 per NEC® or local jurisdiction.
- Do not install dimmers/switches to control receptacles or motor-operated appliances.

Job Name:	Model Numbers:
Job Number:	

## Specifications

### Regulatory Approvals

- UL® Listed to U.S. and Canadian safety requirements
- Complies with Title 20 and Title 24 Section 110.9<sup>2</sup>
- NOM Certification

### Power

- Operating voltage: 120/277 V~ 50/60 Hz, 8 A (USA and Mexico), 120 V~ 50/60 Hz, 8 A (Canada) of 0–10 V== electronic fluorescent ballasts or LED drivers for sensor dimmer, and all lighting loads for sensor switch
- Operating voltage for fan: 120 V~ 50/60 Hz, up to 4.4 A (1/6 HP)<sup>1</sup>

### Loads

- **Sensor Dimmer**
  - Works with all ballasts and drivers that provide a current source compliant to IEC 60929 Annex E.2, and whose inrush current does not exceed NEMA 410 standards for electronic fluorescent ballast and LED driver loads of 8 A steady state current
  - Supports Electronic Off functionality for voltages less than 0.5 V
  - 50 mA max sink current
  - Controls up to 25 ballasts or drivers (IEC 60929 Annex E.2 requires the ballast/driver to limit the current to 2.0 mA maximum)
  - No minimum load
- **Sensor Switch**
  - Works with all lighting loads and fan loads up to 4.4 A
  - Can control light and fan loads simultaneously<sup>1</sup>

### Environment

- Ambient operating temperature: 32 °F to 104 °F (0 °C to 40 °C), 0%–90% humidity, non-condensing; indoor use only

### Warranty

- 5 Year Limited Warranty
- For additional Warranty information, please visit:  
[www.lutron.com/TechnicalDocumentLibrary/Sensor\\_Warranty.pdf](http://www.lutron.com/TechnicalDocumentLibrary/Sensor_Warranty.pdf)

## Key Design Features

### Dimmer

- On a single-tap, lights fade On to previous level or fade Off
- On a double-tap, lights go to full On
- Light levels can be fine-tuned by pressing and holding the dimming rocker until the desired light level is reached
- High-end trim (adjust maximum light level that can be achieved for energy savings or personal preference)
- Low-end trim (adjust minimum light level that can be dimmed down to prevent flickering lights or personal preference)

### System Communications and Capacity

- Maestro Wireless controls communicate with the Pico remote controls and Radio Powr Savr sensors through radio frequency (RF).
- Receives wireless inputs from up to 10 Pico remote controls, 10 Radio Powr Savr occupancy/vacancy sensors, and 1 Radio Powr Savr daylight sensor.
- Maestro Wireless controls must be located within 60 ft (18 m) line-of-sight or 30 ft (9 m) through walls of Radio Powr Savr sensors and Pico remote controls. The 60 ft (18 m) range is not reduced by a ceiling tile obstruction.

### Additional Information on Sensors

- For more information, please see [www.lutron.com/occvacsensors](http://www.lutron.com/occvacsensors)
- Lutron Customer Assistance: 1.844.LUTRON1

<sup>1</sup> When controlling light and fan loads simultaneously with a single switch, the maximum load capacity per switch is 4.4 A at 120 V~. Only the sensor switch can be used to control fan loads.

<sup>2</sup> This only applies to the Vacancy versions of these devices.

<b>Job Name:</b>	<b>Model Numbers:</b>
<b>Job Number:</b>	

## Custom Settings (default settings shown in **bold**)

**Note:** This is how to program these settings in Stand-Alone applications (when not part of the Vive system). For a complete list and description of available settings for Stand-Alone applications, refer to Application Note #687 (048687) at [www.lutron.com](http://www.lutron.com). For set-up, programming, and troubleshooting with a Vive system, please refer to the installation instructions included with the Vive hub or at [www.lutron.com/vive](http://www.lutron.com/vive)

### Timeout

- 30 min
- **15 min**
- 5 min
- 1 min

### Mode: Sensor Modes<sup>1</sup>

Lights automatically turn off in all sensor modes

- **Occ: Occupancy mode (Auto-On / Auto-Off)**
- Lrn: Occupancy with learning ALD mode<sup>2</sup>
- Fixd: Occupancy with fixed ALD mode<sup>2</sup>
- Vac: Vacancy mode (Manual-On / Auto-Off)

### PIR: Passive Infrared Sensitivity

- **High**
- Med
- Low
- Min

### Fixed ALD Light Level<sup>2,3</sup>

- High
- Med
- **Low<sup>4</sup>**
- Min

## Walk-Thru Mode (MRF2S-8SD010 and MRF2S-8SS only)<sup>2</sup>

- **Disabled**
- Enabled

### Occupancy Level<sup>5,6</sup>

A programmable setting that determines the light level the sensor dimmer will turn on to once occupancy has been detected

### Vacancy Level<sup>5,6</sup>

The level to which the sensor dimmer dims or turns off when motion has not been detected for the timeout period

### Electronic Off<sup>2,6,7</sup>

- Enabled
- **Disabled**

### Low-End Trim<sup>6,8</sup>

- Fully adjustable from 1% to 45%

### High-End Trim<sup>6,8</sup>

- Fully adjustable from 55% to 100%

<sup>1</sup> Sensor Mode is locked as "Vacancy" in vacancy only models (MRF2S-8SDV010 and MRF2S-8SSV), in standalone applications. This restriction is removed in the Vive system.

<sup>2</sup> Setting not available once device is configured in the Vive system.

<sup>3</sup> ALD is when the sensor determines how much ambient light is enough, based on a fixed level you select. If there is enough light, it will NOT turn the lights On.

<sup>4</sup> Low is the default setting for any sensor that is set by the user to "Occupancy with fixed ALD mode".

<sup>5</sup> Fully adjustable from 1% to 100% within the adjustable range of low-end and high-end trim.

<sup>6</sup> Only available with the sensor dimmer. Not available with sensor switch.

<sup>7</sup> If enabled, the driver remains powered, but the lights turn off. This requires that the driver support this method of control. If disabled, the driver had power removed every time the lights are turned off. All drivers support this method of control.

<sup>8</sup> Setting is fully variable within each range.



Job Name:	Model Numbers:
Job Number:	

### Placement and Operation

- The ability of the sensor dimmer/switch to detect motion requires line-of-sight of room occupants and must have an unobstructed view.
- Hot objects and moving air currents can affect the performance of the sensor dimmer/switch. For best performance, the sensor dimmer/switch should be mounted at least 4 ft (1.2 m) away from HVAC vents and light bulbs.
- The performance of the sensor dimmer/switch depends on a temperature differential between the ambient room temperature and that of room occupants. Warmer rooms may reduce the ability of the sensor dimmer/switch to detect occupants.

### NEMA WD7 Test Grid Coverage

(High Sensitivity Setting)

-  Major motion coverage: 900 ft<sup>2</sup> (81 m<sup>2</sup>)
-  Minor motion coverage: 400 ft<sup>2</sup> (36 m<sup>2</sup>)

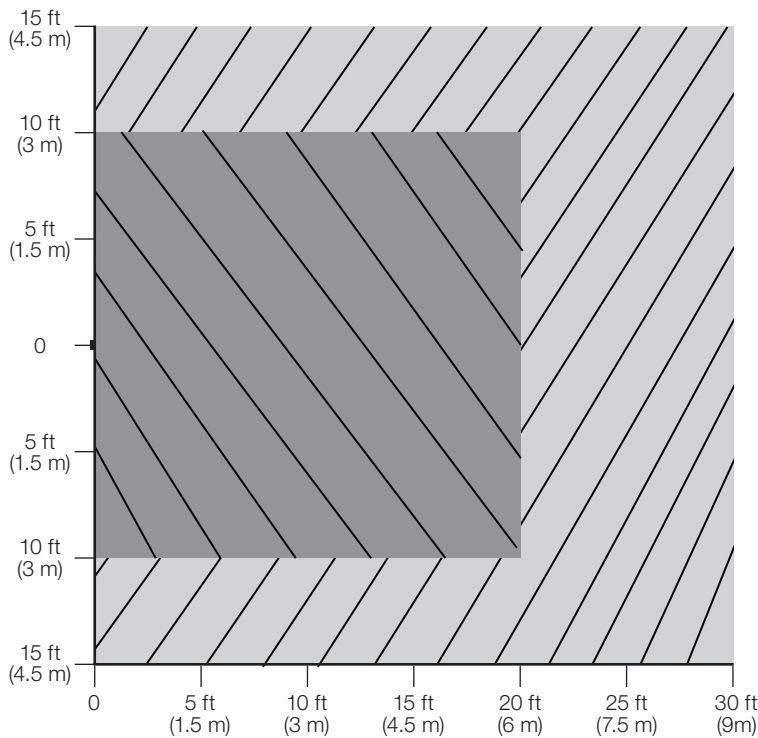

### Horizontal Beam Diagram

(For Reference Only)

-  Beam 1
-  Beam 2

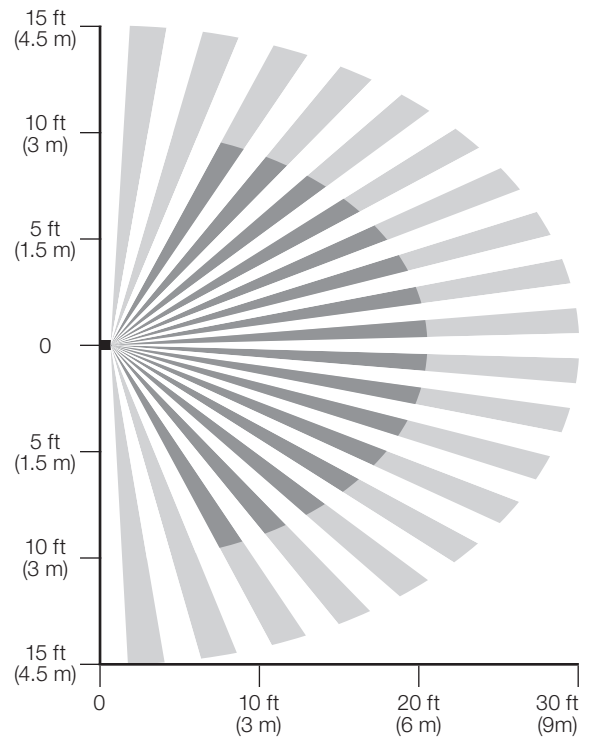

### Vertical Beam Diagram

(For Reference Only)

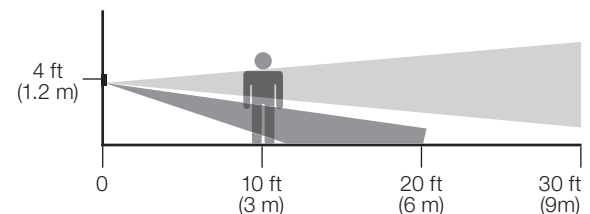

Job Name:	Model Numbers:
Job Number:	

## Dimensions

Measurements shown as: in (mm)

### Dimmer

Front View

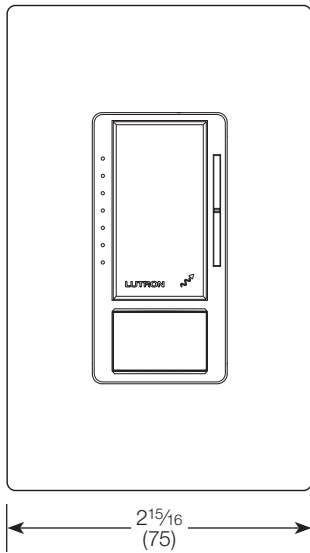

Side View

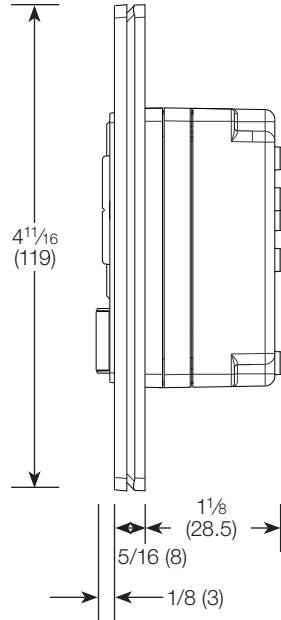

## Operation

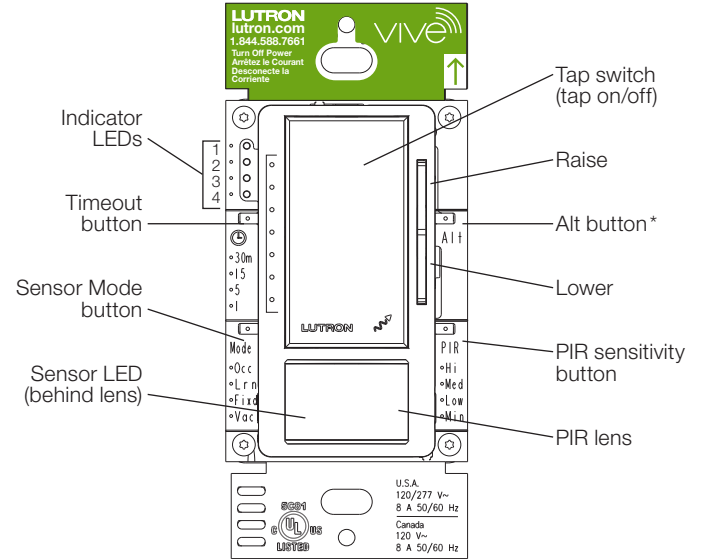

### Switch

Front View

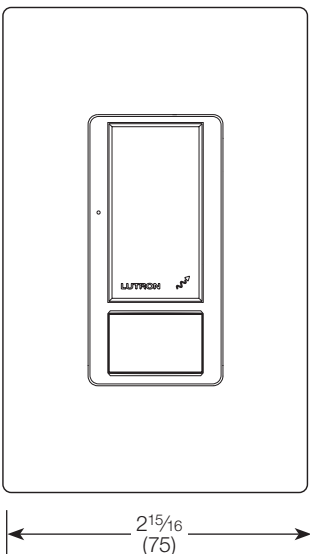

Side View

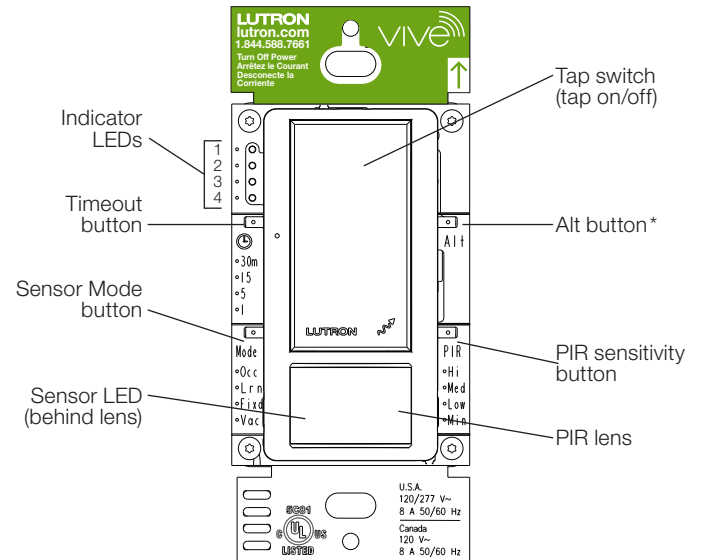
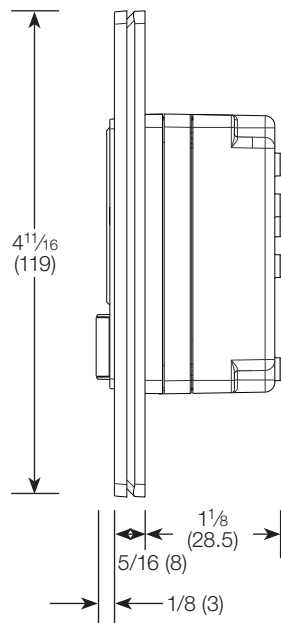

\* Alt button is always used in conjunction with another button.

Job Name:	Model Numbers:
Job Number:	

### Mounting\*

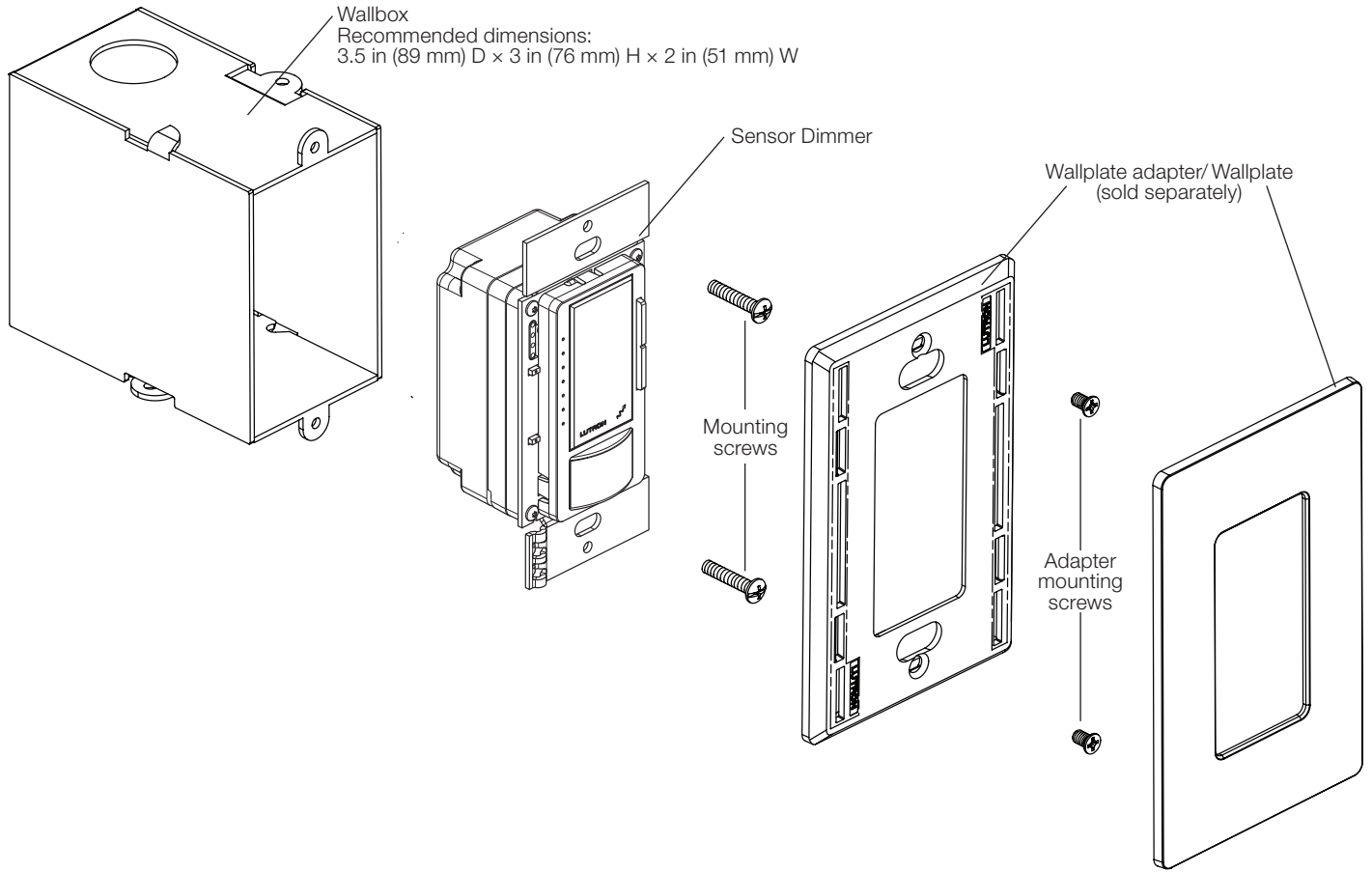

\* Mounting is the same for the dimmer and the switch.

Job Name:	Model Numbers:
Job Number:	

# Wiring Connections

In order to function all wires must be connected. Before installing wallplate, program all desired settings.

## Dimmer

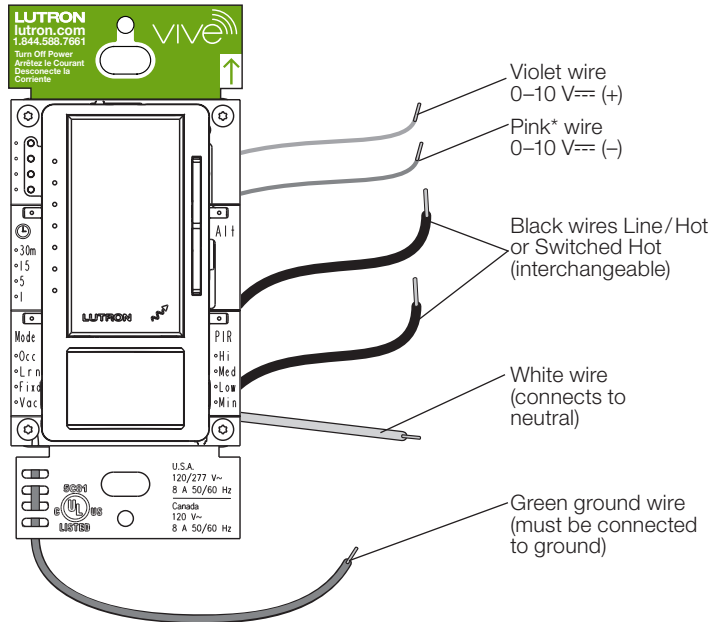

## Switch

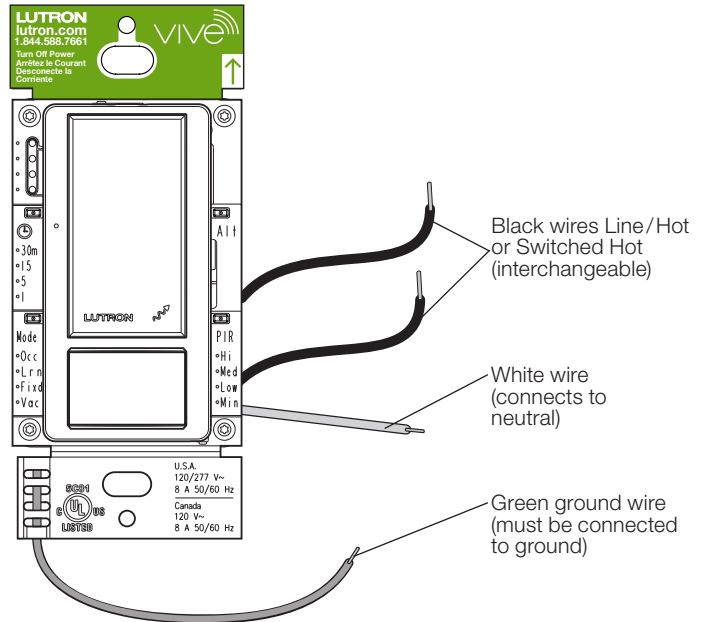

\* This wire/terminal may be gray on older products or in retrofit applications.

Job Name:	Model Numbers:
Job Number:	



### Wiring: Single-Pole Dimmer Installation

Neutral Connection Required

Up to 25 drivers total and up to 50 mA maximum

Up to 25 drivers total and up to 8 A maximum

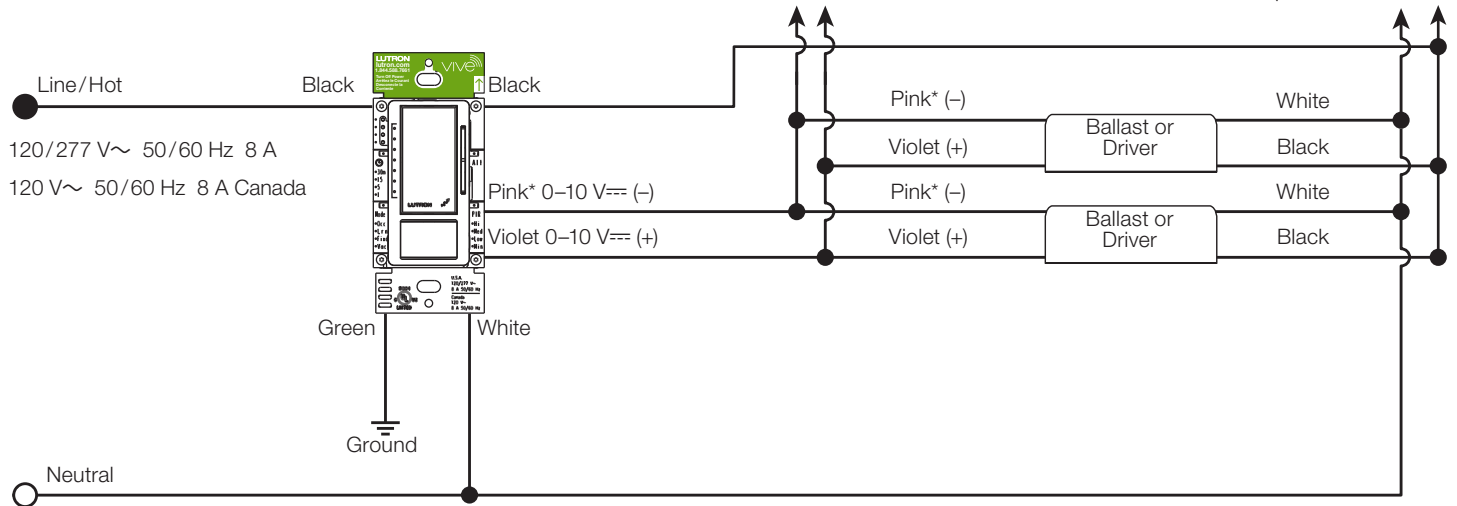

\* This wire/terminal may be gray on older products or in retrofit applications.

### Wiring: Single-Pole Switch Installation

Neutral Connection Required

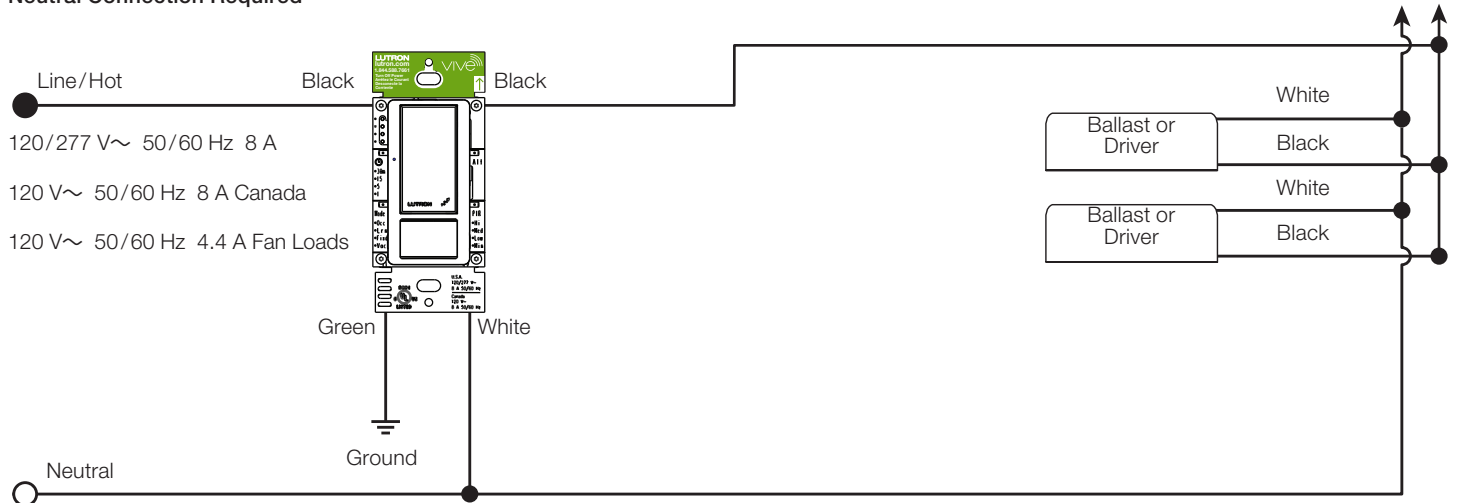

### Wiring: 3-Way and Multi-Location Installation

For instructions on how to install these devices in a multi-location retrofit or new application such as a 3-way installation, please refer to the app note located at [www.lutron.com/TechnicalDocumentLibrary/048687.pdf](http://www.lutron.com/TechnicalDocumentLibrary/048687.pdf)

Job Name:	Model Numbers:
Job Number:	

## Colors and Finishes

### Gloss Finishes

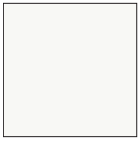

White  
WH



Ivory  
IV

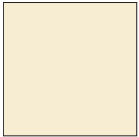

Almond  
AL



Light Almond  
LA

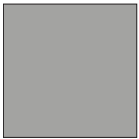

Gray  
GR



Brown  
BR



Black  
BL

- Due to printing limitations, colors and finishes shown cannot be guaranteed to perfectly match actual product colors.
- Color chip keychains are available for more precise color matching:
  - Gloss Finishes: DG-CK-1

 Lutron, Lutron, Maestro, Clear Connect, Vive, Pico, Radio Powr Savr, XCT, and C•L are trademarks or registered trademarks of Lutron Electronics Co., Inc. in the US and/or other countries. All other product names, logos, and brands are property of their respective owners.

<p><b>Job Name:</b></p> <p><b>Job Number:</b></p>	<p><b>Model Numbers:</b></p>
--	------------------------------