

Hi-lume 1% EcoSystem/3-Wire L3D Driver Overview

Hi-lume 1% EcoSystem/3-Wire Driver is a high-performance LED driver that provides smooth, continuous 1% dimming for virtually any LED fixture, whether it requires constant-current or constant-voltage. It is the most versatile LED driver offered today due to its compatibility with a wide variety of LED arrays, multiple form factors, and numerous control options.

Features

- Continuous, flicker-free dimming from 100% to 1%.
- Compatible with Energi Savr Node unit with EcoSystem, GRAFIK Eye QS control unit, PowPak dimming module with EcoSystem, and Quantum systems, allowing for integration into a planned or existing EcoSystem lighting control solution. Please see **Compatible Controls** chart or contact Lutron for details regarding compatible controls.
- Standard 3-wire, line-voltage phase-control technology for consistent dimming performance and compatibility with all Lutron 3-wire fluorescent controls.
- QwikFig compatible. For more information please refer to Lutron P/N 367-2533 (K and M case only).
- Line voltage miswire protection on EcoSystem control inputs.
- 100% performance tested at factory.
- A rated lifetime of 50,000 hours @:
 - $t_c = 149^\circ\text{F}$ (65°C) for 40 W drivers
 - $t_c = 158^\circ\text{F}$ (70°C) for 50 W drivers
- UL recognized and listed options for United States and Canada.
- NOM certified option for Mexico.
- Type TL Rated.
- FCC Part 15 Class A
- Pulse Width Modulation (PWM) or Constant-Current Reduction (CCR) dimming methods available. See Application Note #360 for details.
- RoHS Compliant.
- For more information please go to: www.lutron.com/hilume1led

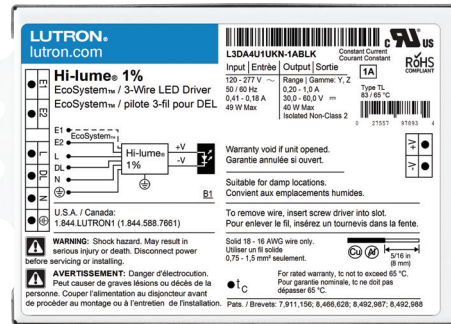

Case type K

3.00 in (76 mm) W x 1.00 in (25 mm) H x 4.90 in (124 mm) L



Case type M

1.18 in (30 mm) W x 1.00 in (25 mm) H x 14.25 in (362 mm) L

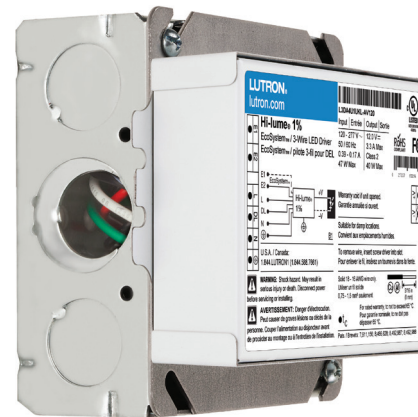

Case type KL

K-case mounted on a 4.00 in (102 mm) W x 1.50 in (38 mm) H x 4.00 in (102 mm) L junction box to provide wiring compartment

The Hi-lume 1% EcoSystem/3-Wire family of drivers includes models which operate at a maximum power of 40 W or less as well as models which can operate up to 50 W.

- 40 W or less models – output ranges A-M and X-Z
 - 50 W models – output ranges N and W (K-case only)
- For a description of the output ranges please see following pages.

Job Name:

Model Numbers:

Job Number:

Specifications

Regulatory Approvals

- Meets ANSI C62.41 category A surge protection standards up to and including 4 kV.
- FCC Part 15 Class A
- CAN ICES-005(A)
- Manufacturing facilities employ ESD reduction practices that comply with the requirements of ANSI/ESD S20.20.
- Lutron Quality Systems registered to ISO 9001.2008.
- UL 8750 recognized.
- UL recognized models are also UL classified to 1598C for field replacement capability
- UL 8750 listed form factor available.
- Class 2 output available.
- Type TL Rated.
- L3DA4U1UKL-AV120 and L3DA4U1UKL-CV240 models are NOM certified and available for Mexico.

UL 8750 Listed Option

- cULus for United States and Canada available for certain operating regions.
- Pre-wired and installation ready.
- See **KL Enclosure** page for more specific details regarding UL listed option.
- UL 8750 Listed construction.
- Integral junction box to save time.
- For maximum driver-to-LED light engine wire length, see **Driver Leads** section near the end of this document.

Environmental

- Sound Rating: Inaudible in 27 dB ambient.
- Relative Humidity: Maximum 90% non-condensing.
- Minimum operating ambient temperature $t_a = 32\text{ }^\circ\text{F}$ ($0\text{ }^\circ\text{C}$).

Performance

- Dimming Range: 100% to 1%.
- Operating Voltage: 120 V \sim /277 V \sim at 50/60 Hz.
- Lifetime: 50,000 hours @:
 - $t_c = 149\text{ }^\circ\text{F}$ ($65\text{ }^\circ\text{C}$)¹ for 40 W drivers.
 - $t_c = 158\text{ }^\circ\text{F}$ ($70\text{ }^\circ\text{C}$)¹ for 50 W drivers.
 - For rated warranty, t_c not to exceed 149 °F (65 °C) for 40 W drivers and 158 °F (70 °C) for 50 W drivers (maximum rated temperatures).¹
- Patented thermal foldback protection.
- LEDs turn on to any dimmed level without going to full brightness.
- Non-volatile memory restores all driver settings after power failure.
- Power Factor: >0.90 for loads greater than 25 W
- Standby Power Consumption: <1.0 W
- Total Harmonic Distortion (THD): <20% for loads greater than 25 W.
- Inrush Current: <2 A.
- Inrush Current Limiting Circuitry: eliminates circuit breaker tripping, switch arcing and relay failure.
- Open circuit protected.
- Short circuit protected.
- Turn-on time: ≤ 1.5 seconds.²
- PWM Dimming Frequency: 550 Hz.

Driver Wiring and Mounting

- Driver is grounded by a mounting screw to the grounded fixture (or by terminal connection on the K-case).
- Terminal blocks on the driver accept one solid wire per terminal from 18 AWG to 16 AWG (0.75 mm^2 to 1.5 mm^2).
- Fixture must be grounded in accordance with local and national electrical codes.
- For maximum driver to LED light engine wire lengths see **Driver Leads** section at end of document.

¹ Installer is responsible for ensuring that the driver case temperature does not exceed the maximum rated temperature.

² Models available with turn-on time ≤ 1 second.

Job Name: Job Number:	Model Numbers:
--	-----------------------

How to Build a Model Number: Hi-lume 1% EcoSystem/3-Wire

L3DA U1U -

Maximum Power:
 4 = 40 W maximum
 5 = 50 W maximum (K-case only)

Example: L3DA4U1UKS-HC070
 For further assistance selecting your model number, contact our LED Center of Excellence at 1.877.346.5338 or LEDs@lutron.com

Current Level (for Constant-Current):
 020 = 0.20 A; 021 = 0.21 A . . . 070 = 0.70 A . . . 210 = 2.10 A

Voltage Level (for Constant-Voltage):
 100 = 10.0 V; 105 = 10.5 V . . . 600 = 60.0 V

Case Size:
 K = Compact
 M = Stick

Case Style:
 S = Studded (K case only)
 N = Non-Studded
 L = UL Listed (K case only)

Driver Output:
 C = Constant-current driver with pulse width modulation (PWM) dimming
 A = Constant-current driver with constant-current reduction (CCR) dimming
 V = Constant-voltage driver with pulse width modulation (PWM) dimming

LED Load Output Range (see the following pages for more detail):

<p>40 W Drivers</p> <p><u>Class 2 Constant-Voltage</u> A = 10.0 V–12.0 V* B = 12.5 V–20.0 V** C = 20.5 V–24.0 V** D = 24.5 V–38.0 V**</p> <p><u>Isolated Non-Class 2 Constant-Voltage</u> X = 38.5 V–60.0 V**</p>	<p><u>Class 2 Constant-Current</u> E = 0.20 A–0.50 A 30 V–54 V F = 0.51 A–1.00 A 30 V–54 V** G = 0.20 A–0.70 A 8 V–20 V H = 0.20 A–0.70 A 15 V–38 V I = 0.71 A–1.05 A 8 V–20 V J = 0.71 A–1.05 A 15 V–38 V K = 1.06 A–1.50 A 8 V–20 V L = 1.06 A–1.50 A 15 V–38 V** M = 1.51 A–2.10 A 8 V–19.9 V**</p> <p><u>Isolated Non-Class 2 Constant-Current</u> Y = 0.20 A–0.50 A 30 V–60 V Z = 0.51 A–1.00 A 30 V–60 V**</p>	<p>50 W Drivers</p> <p><u>Class 2 Constant-Current</u> N = 0.71 A–1.05 A 35 V–54 V**</p> <p><u>Isolated Non-Class 2 Constant-Current</u> W = 0.71 A–1.05 A 35 V–60 V**</p>
---	---	---

* 3.33 A maximum.
 ** Output parameter is power-limited for these output ranges. Consult detailed specifications on the following pages for each range.

How to Build a Bulk Model Number (For use with Lutron QwikFig technology): Hi-lume 1% EcoSystem/3-Wire

40 W Drivers

L3DA4U1U - BLK

Case Size:

K = Compact
M = Stick

Case Style:¹

S = Studded
(K-case only)
N = Non-Studded
(All M-case models)

Bulk Models:

Coverage based on “LED Load Output Range” from standard non-configurable models shown in the **How to Build a Model Number** section.

Example Standard model number: L3DA4U1UKS-HC070 has LED load output range = H

K-case and M-case

1A = Covers “LED Load Output Range” Y and Z
2A = Covers “LED Load Output Range” M
3A = Covers “LED Load Output Range” E and F (CCR dimming only)

K-case only

2G = Covers “LED Load Output Range” G
2H = Covers “LED Load Output Range” H
2R= Covers “LED Load Output Range” I and K
2S= Covers “LED Load Output Range” J and L

M-case only

2B = Covers “LED Load Output Range” H, J, and L
2C = Covers “LED Load Output Range” G, I, and K

50 W Drivers

L3DA5U1UK - BLK

Case Style:

S = Studded
N = Non-Studded

1B = Covers “LED Load Output Range” W
3B = Covers “LED Load Output Range” N (CCR dimming only)

Note: Only the model numbers falling into the structure listed above can be configured with QwikFig. Standard model numbers configured at Lutron will not be capable of being reconfigured at another facility.

¹ QwikFig bulk drivers are only available as UL recognized.

Job Name:	Model Numbers:
Job Number:	

“A” Output Range, Voltage Driver Models

Driver Type	Output Dimming Method	Output Voltage	Output Current	Output Power	Standards Recognition	KL Case Option	Standards Recognition for KL Case
Constant-Voltage Driver (Class 2)	Pulse Width Modulation (PWM)	10.0–12.0 V PWM	0.42–3.3 A	5–40 W		Yes	

Voltage Driver Operation Range:

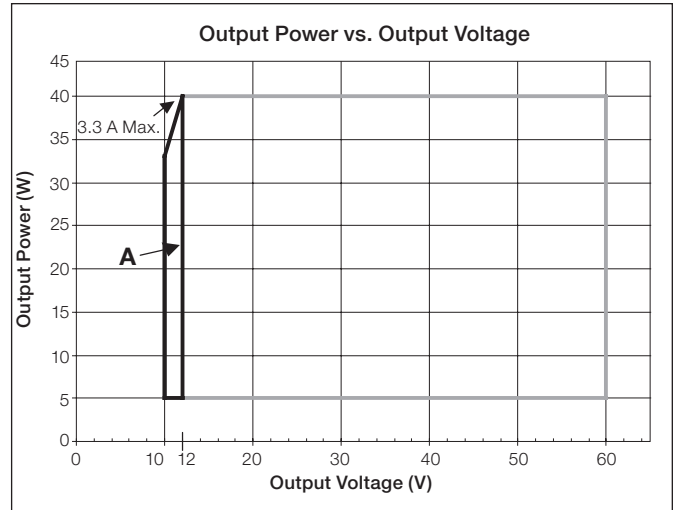
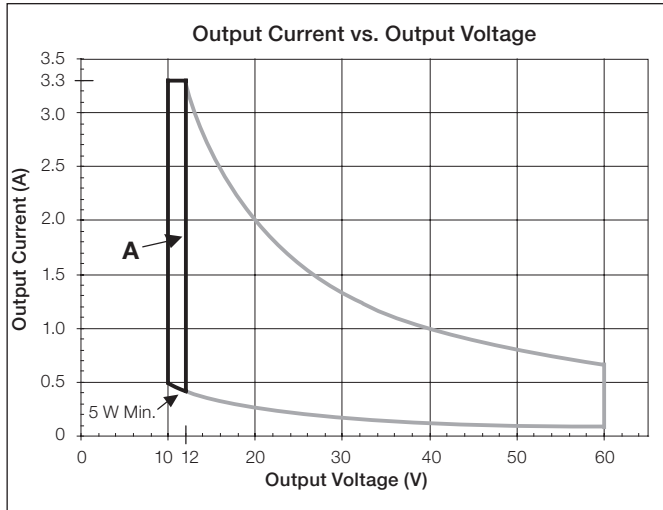

Typical Performance Specifications:

Parameter	120 V~	240 V~	277 V~	Test Conditions
Input Current	390 mA	210 mA	170 mA	t _a = 25 °C, 12.0 V 40 W load, Maximum Light Output, K-case
Power Factor	0.99	0.97	0.95	
THD	14%	17%	16%	
Driver Efficiency	81%	83%	83%	

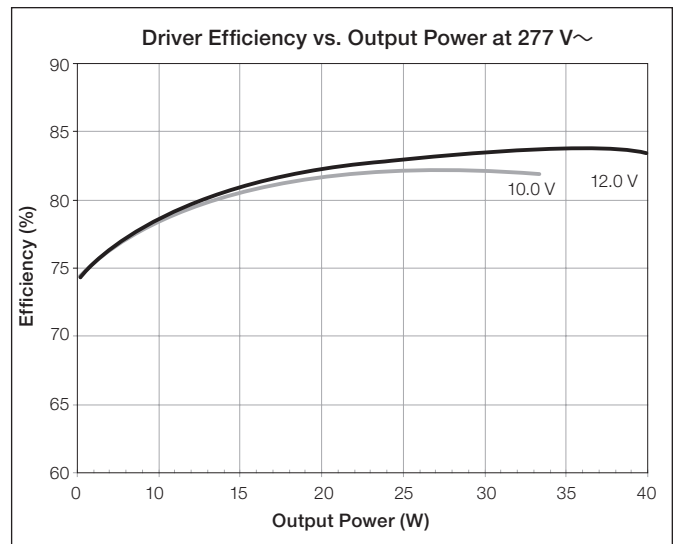
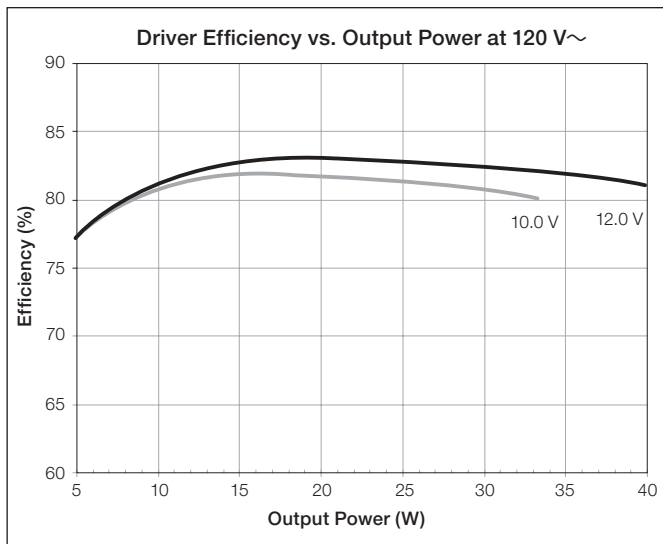

Job Name:	Model Numbers:
Job Number:	

“B” Output Range, Voltage Driver Models

Driver Type	Output Dimming Method	Output Voltage	Output Current	Output Power	Standards Recognition	KL Case Option	Standards Recognition for KL Case
Constant-Voltage Driver (Class 2)	Pulse Width Modulation (PWM)	12.5–20.0 V PWM	0.25–3.2 A	5–40 W		Yes	

Voltage Driver Operation Range:

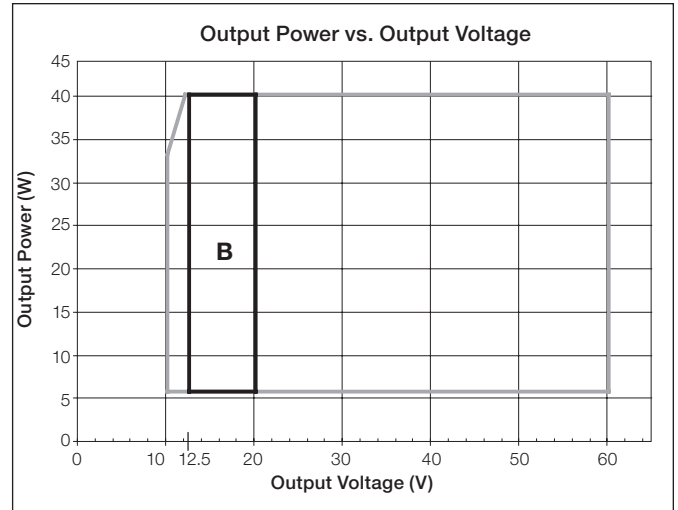
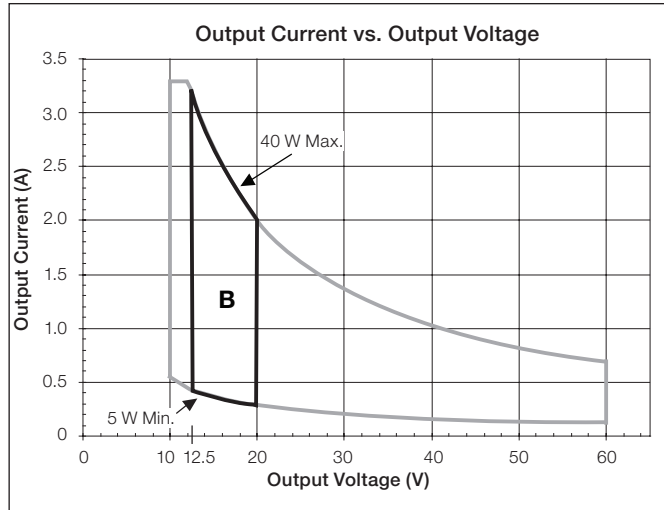

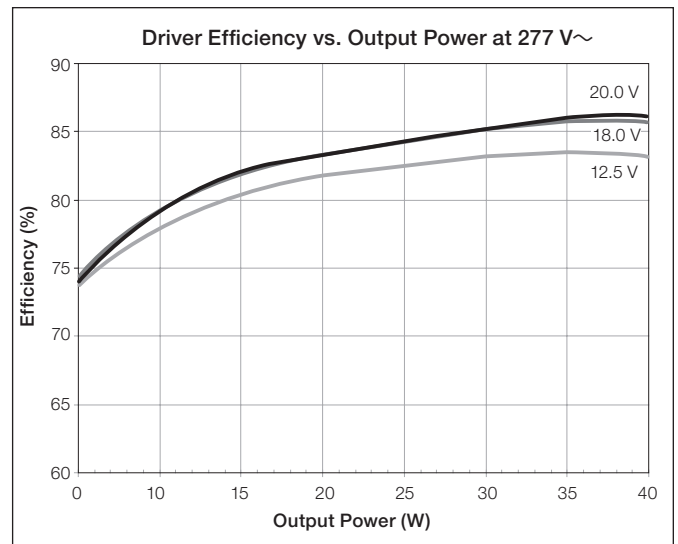
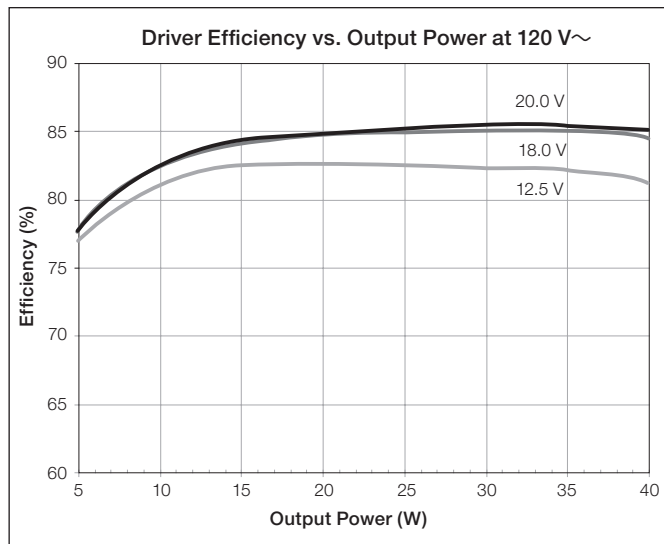

Typical Performance Specifications:

Parameter	120 V~	240 V~	277 V~	Test Conditions
Input Current	390 mA	200 mA	170 mA	t _a = 25 °C, 20.0 V 40 W load, Maximum Light Output, K-case
Power Factor	0.99	0.98	0.97	
THD	10%	8%	9%	
Driver Efficiency	85%	86%	87%	



Job Name:	Model Numbers:
Job Number:	

“C” Output Range, Voltage Driver Models

Driver Type	Output Dimming Method	Output Voltage	Output Current	Output Power	Standards Recognition	KL Case Option	Standards Recognition for KL Case
Constant-Voltage Driver (Class 2)	Pulse Width Modulation (PWM)	20.5–24.0 V PWM	0.21–1.95 A	5–40 W		Yes	

Voltage Driver Operation Range:

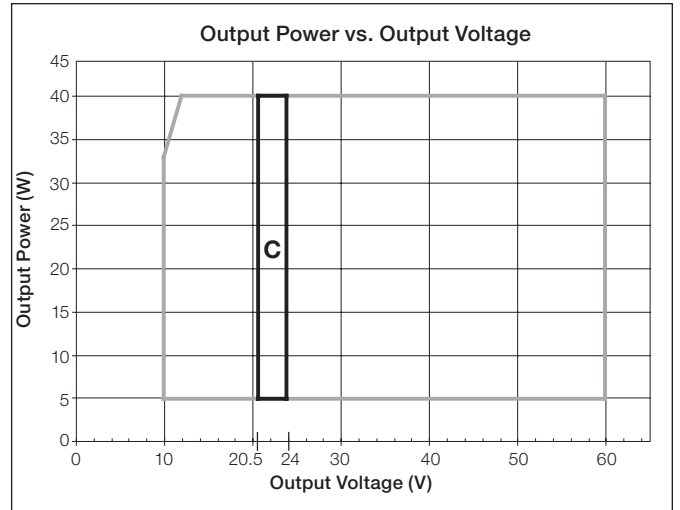
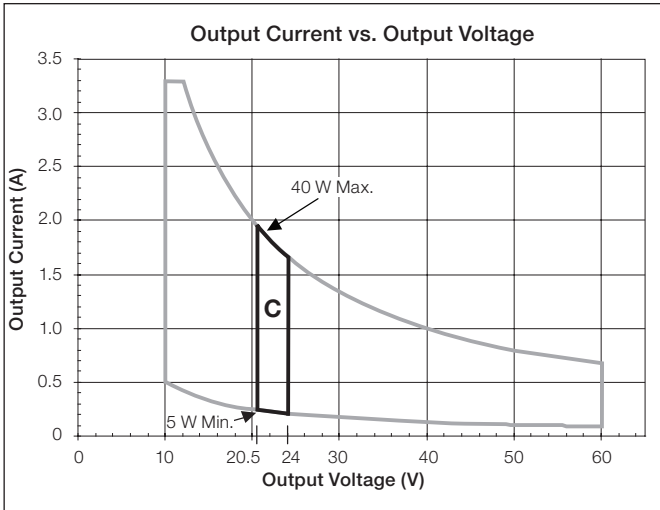

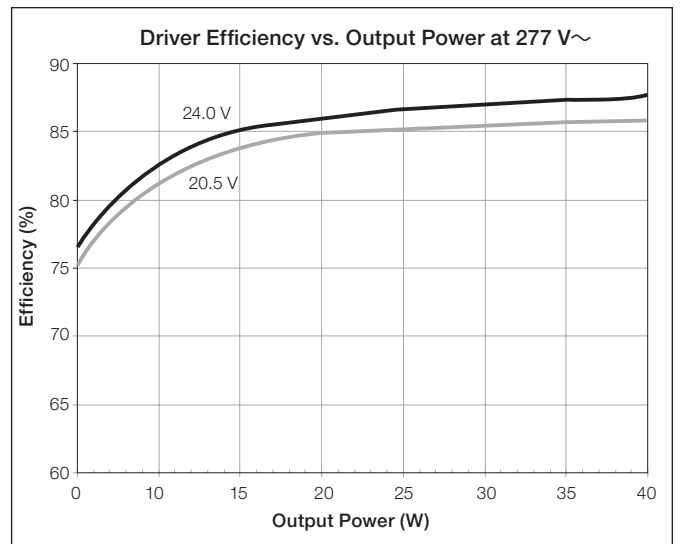
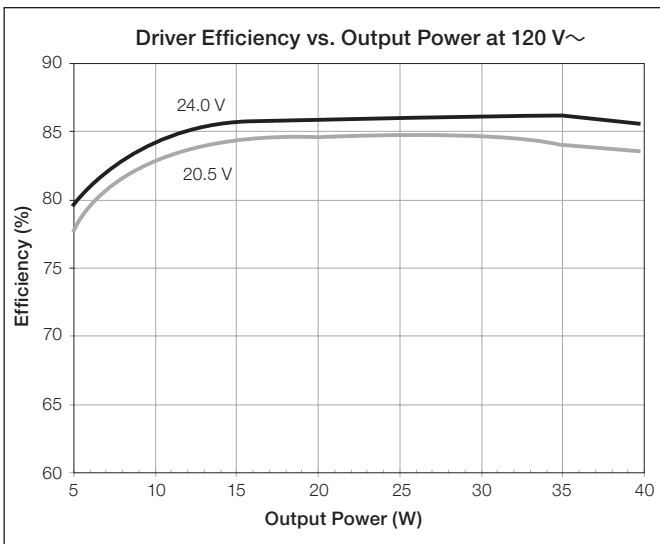

Typical Performance Specifications:

Parameter	120 V~	240 V~	277 V~	Test Conditions
Input Current	370 mA	190 mA	170 mA	t _a = 25 °C, 24.0 V 40 W load, Maximum Light Output, K-case
Power Factor	0.99	0.97	0.96	
THD	10%	10%	12%	
Driver Efficiency	86%	87%	88%	



Job Name:	Model Numbers:
Job Number:	

“D” Output Range, Voltage Driver Models

Driver Type	Output Dimming Method	Output Voltage	Output Current	Output Power	Standards Recognition	KL Case Option	Standards Recognition for KL Case
Constant-Voltage Driver (Class 2)	Pulse Width Modulation (PWM)	24.5–38.0 V PWM	0.13–1.63 A	5–40 W		Yes	

Voltage Driver Operation Range:

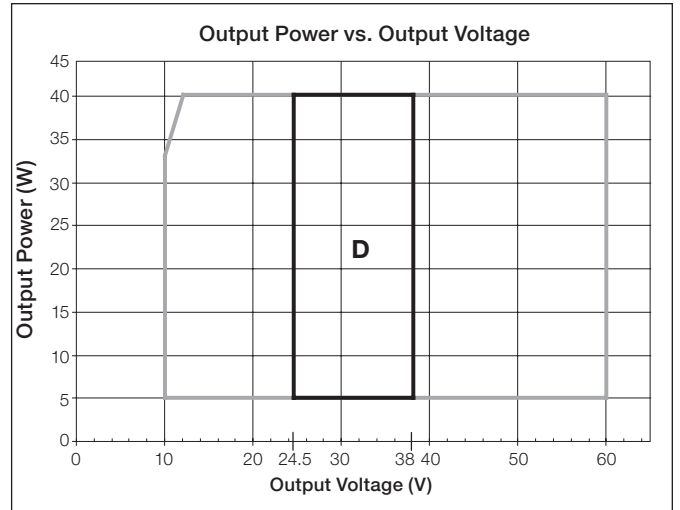
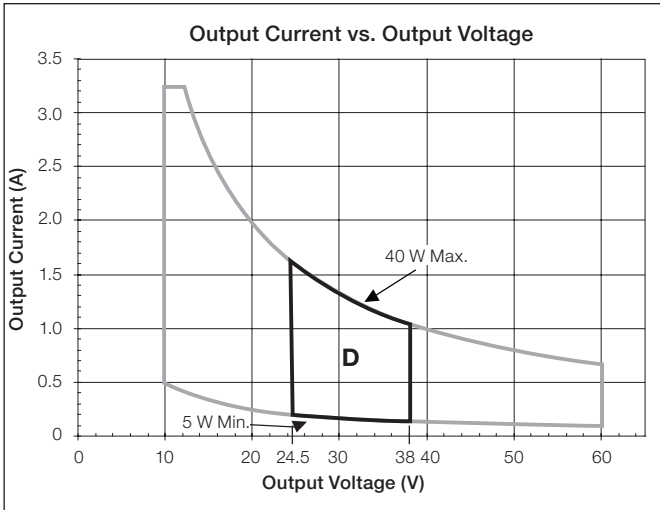

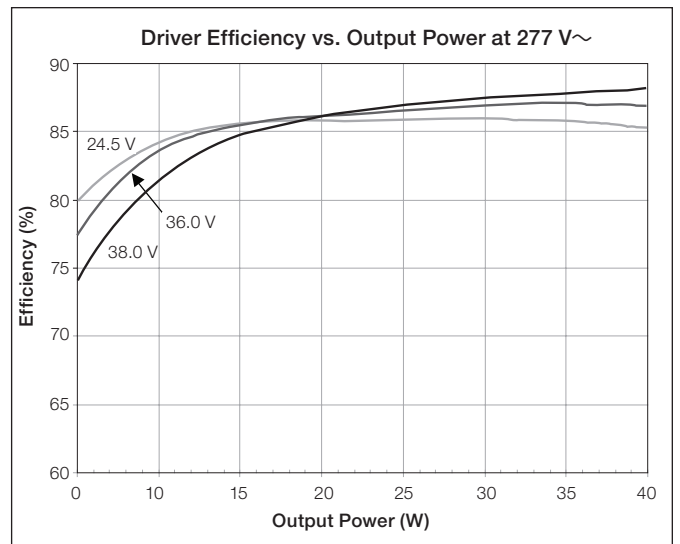
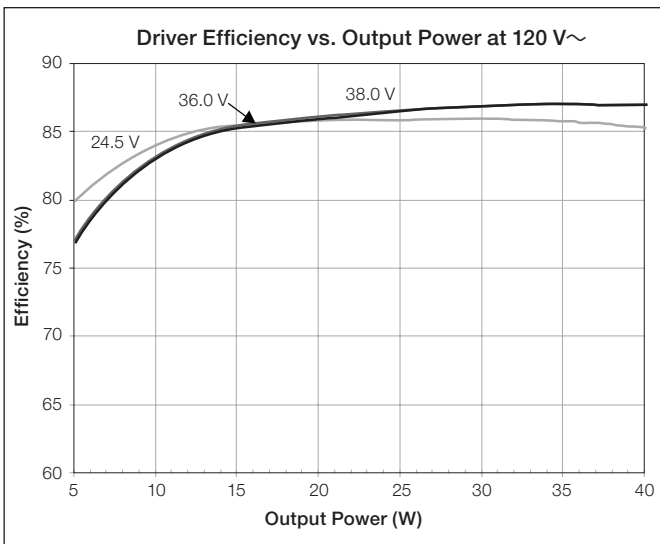

Typical Performance Specifications:

Parameter	120 V~	240 V~	277 V~	Test Conditions
Input Current	370 mA	190 mA	170 mA	t _a = 25 °C, 38.0 V 40 W load, Maximum Light Output, K-case
Power Factor	0.99	0.98	0.98	
THD	6%	9%	11%	
Driver Efficiency	87%	88%	88%	



Job Name:	Model Numbers:
Job Number:	

“E” Output Range, Current Driver Models

Driver Type	Output Dimming Method	Output Voltage	Output Current	Output Power	Standards Recognition	KL Case Option	Standards Recognition for KL Case
Constant-Current Driver (Class 2)	Constant-Current Reduction (CCR)	30–54 V $\overline{=}$	0.20–0.50 A	6–27 W	 Type TL 83 °/66 °C - K-case Type TL 90 °/72 °C - M-case	Yes	

When using QwikFig technology, these models can be built from the following bulk units:

K-case - L3DA4U1UKx-3ABLK*; M-case - L3DA4U1UMN-3ABLK

* x = studded (S) or non-studded (N)

Current Driver Operation Range:

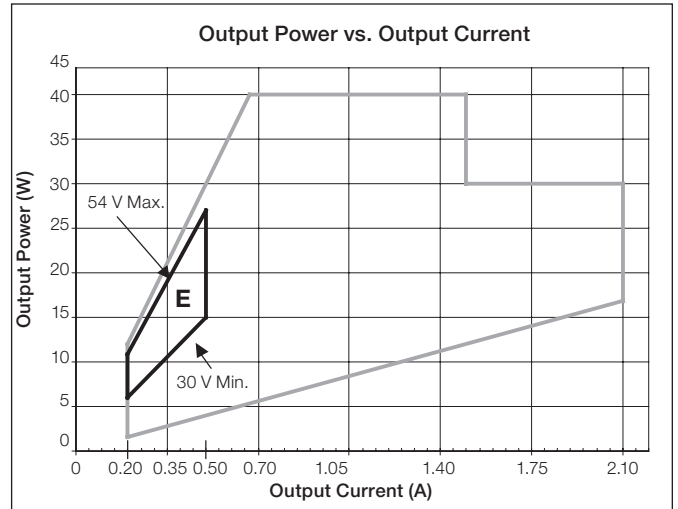
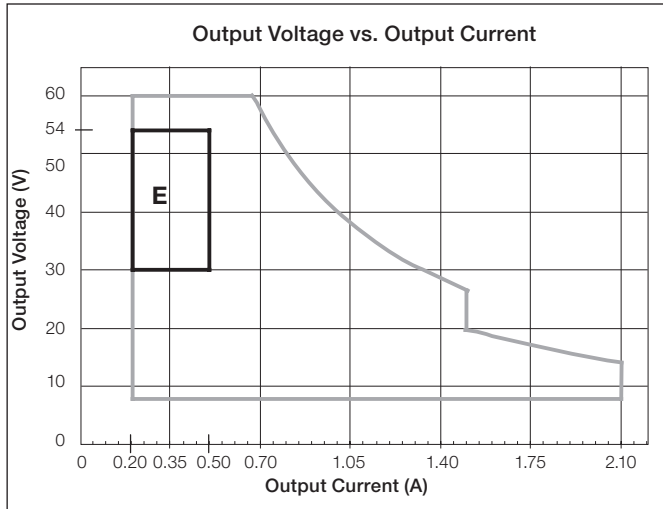

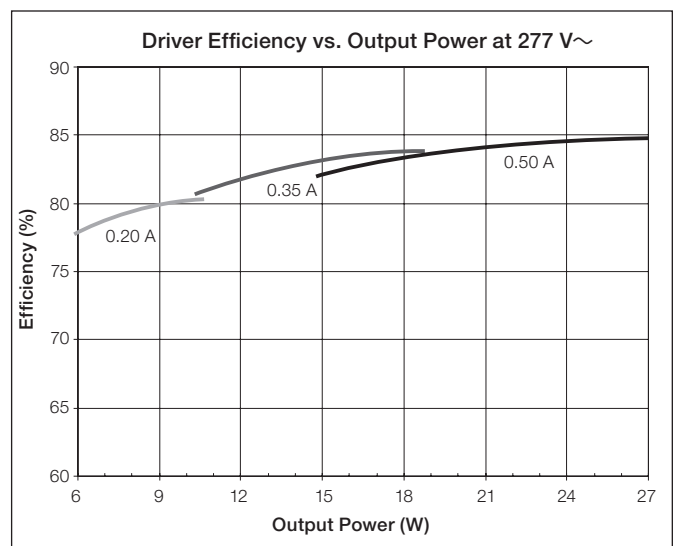
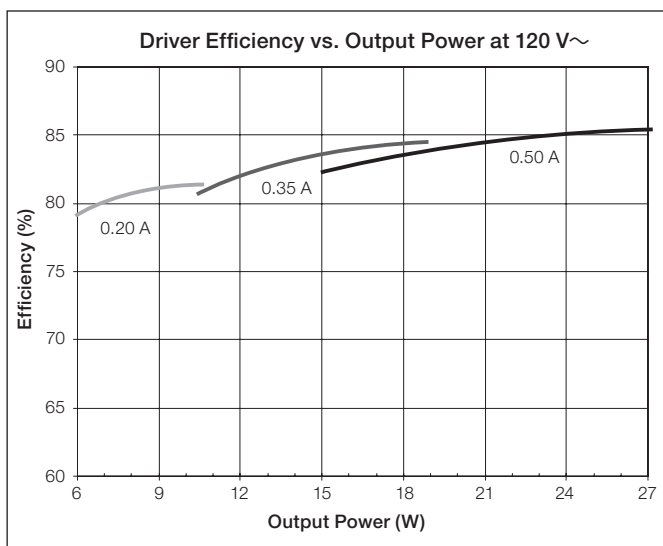

Typical Performance Specifications:

Parameter	120 V \sim	240 V \sim	277 V \sim	Test Conditions
Input Current	260 mA	140 mA	110 mA	$t_a = 25\text{ }^\circ\text{C}$, 0.50 A 27 W load, Maximum Light Output, K-case
Power Factor	0.99	0.98	0.96	
THD	10%	10%	12%	
Driver Efficiency	85%	85%	85%	



Job Name:	Model Numbers:
Job Number:	

“F” Output Range, Current Driver Models

Driver Type	Output Dimming Method	Output Voltage	Output Current	Output Power	Standards Recognition	KL Case Option	Standards Recognition for KL Case
Constant-Current Driver (Class 2)	Constant-Current Reduction (CCR)	30–54 V ^{===*}	0.51–1.00 A	15–40 W	 Type TL 83 °/66 °C - K-case Type TL 90 °/72 °C - M-case	Yes	

When using QwikFig technology, these models can be built from the following bulk units:

K-case - L3DA4U1UKx-3ABLK^{**}; M-case - L3DA4U1UMN-3ABLK

* Output parameter is power-limited for this output range. Consult detailed specifications on this page for the minimum and maximum voltage for each operating current.

** x = studded (S) or non-studded (N)

Current Driver Operation Range:

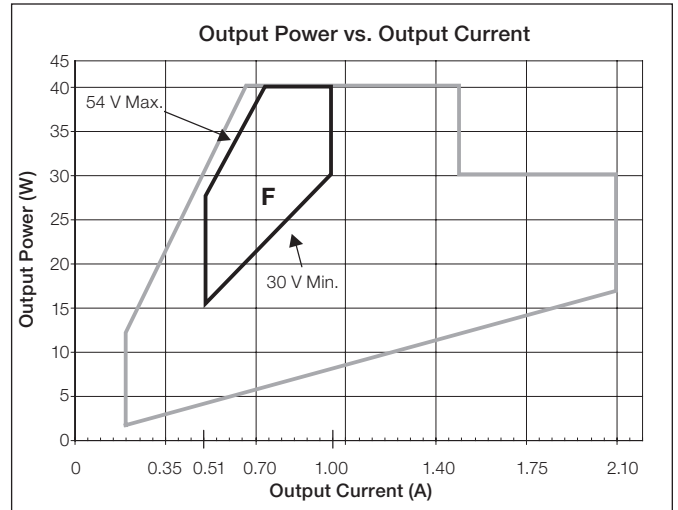
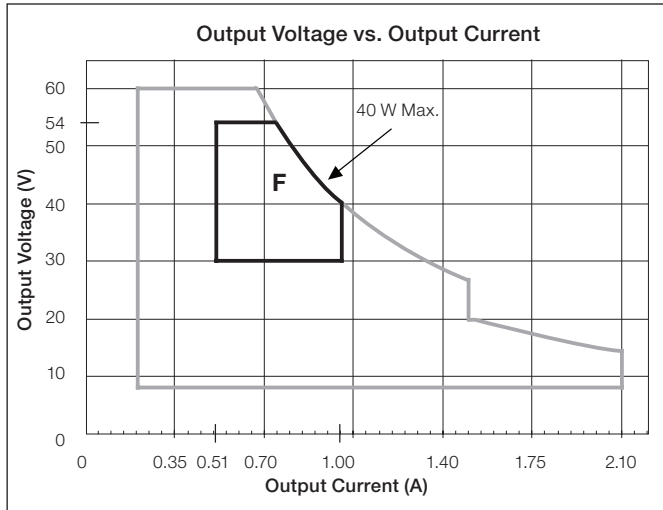

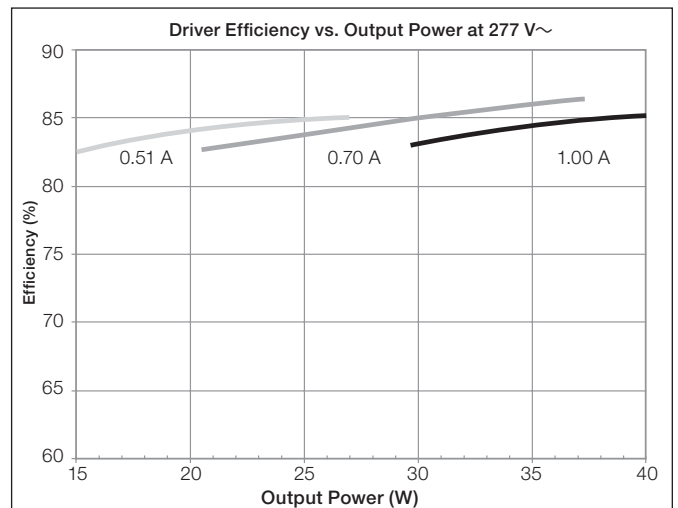
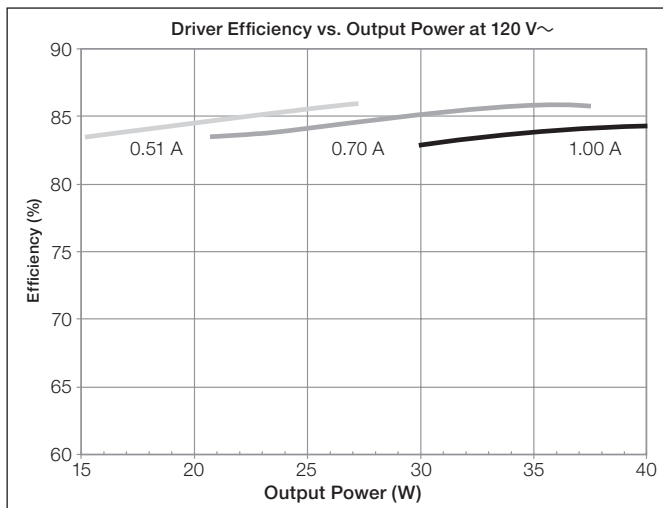

Typical Performance Specifications:

Parameter	120 V [~]	240 V [~]	277 V [~]	Test Conditions
Input Current	380 mA	200 mA	160 mA	t _a = 25 °C, 1.00 A 40 W load, Maximum Light Output, K-case
Power Factor	0.99	0.99	0.98	
THD	8%	9%	11%	
Driver Efficiency	84%	86%	86%	



Job Name:	Model Numbers:
Job Number:	

“G” Output Range, Current Driver Models

Driver Type	Output Dimming Method	Output Voltage	Output Current	Output Power	Standards Recognition	KL Case Option	Standards Recognition for KL Case
Constant-Current Driver (Class 2)	Pulse Width Modulation (PWM)	8–20 V PWM	0.20–0.70 A	2–14 W	 Type TL 87 °/55 °C - K-case Type TL 89 °/68 °C - M-case	Yes	
	Constant-Current Reduction (CCR)	8–20 V=					

When using QwikFig technology, these models can be built from the following bulk units:

K-case - L3DA4U1UKx-2GBLK*; M-case - L3DA4U1UMN-2CBLK

* x = studded (S) or non-studded (N)

Current Driver Operation Range:

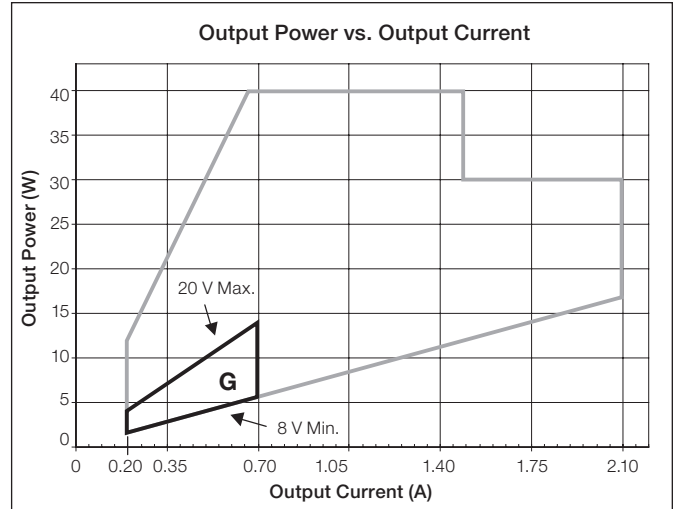
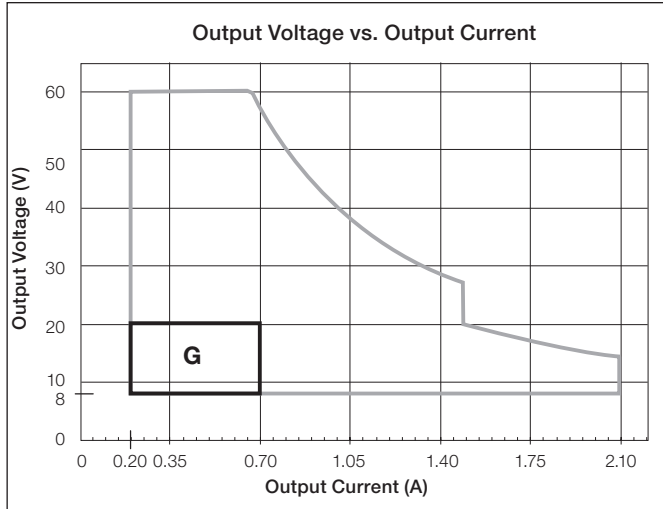

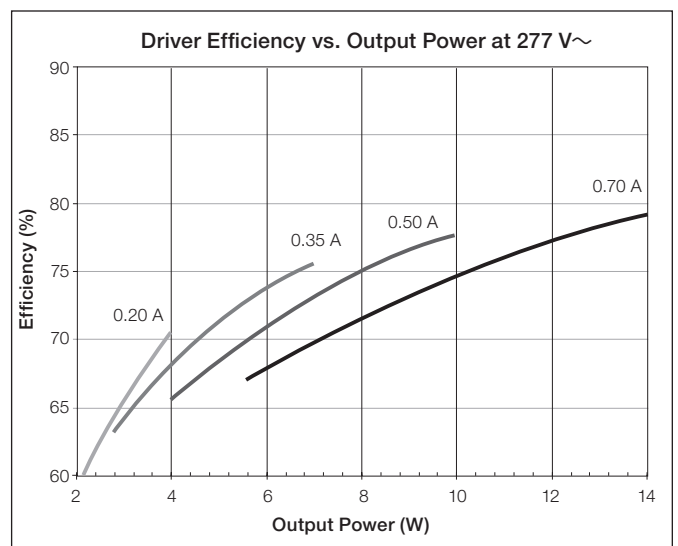
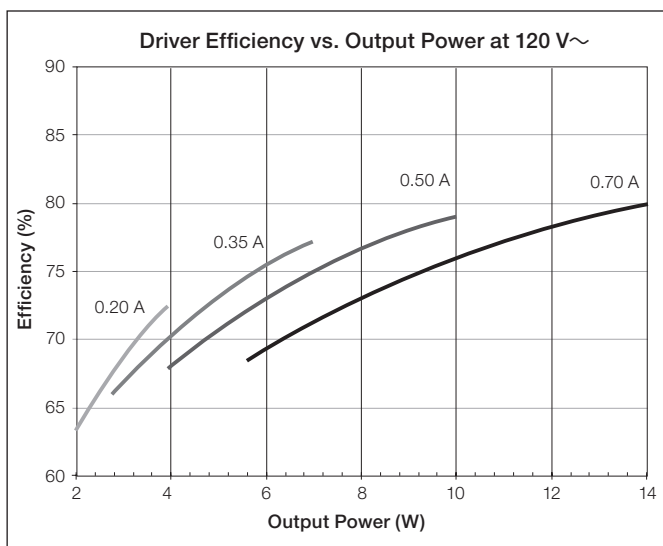

Typical Performance Specifications:

Parameter	120 V~	240 V~	277 V~	Test Conditions
Input Current	140 mA	90 mA	70 mA	t _a = 25 °C, 0.70 A 14 W load, Maximum Light Output, K-case
Power Factor	0.99	0.89	0.85	
THD	11%	16%	20%	
Driver Efficiency	80%	80%	79%	



Job Name:	Model Numbers:
Job Number:	

“H” Output Range, Current Driver Models

Driver Type	Output Dimming Method	Output Voltage	Output Current	Output Power	Standards Recognition	KL Case Option	Standards Recognition for KL Case
Constant-Current Driver (Class 2)	Pulse Width Modulation (PWM)	15–38 V PWM	0.20–0.70 A	3–26.6 W	 Type TL 89 °/61 °C - K-case Type TL 89 °/74 °C - M-case	Yes	
	Constant-Current Reduction (CCR)	15–38 V=					

When using QwikFig technology, these models can be built from the following bulk units:

K-case - L3DA4U1UKx-2HBLK*; M-case - L3DA4U1UMN-2BBLK

* x = studded (S) or non-studded (N)

Current Driver Operation Range:

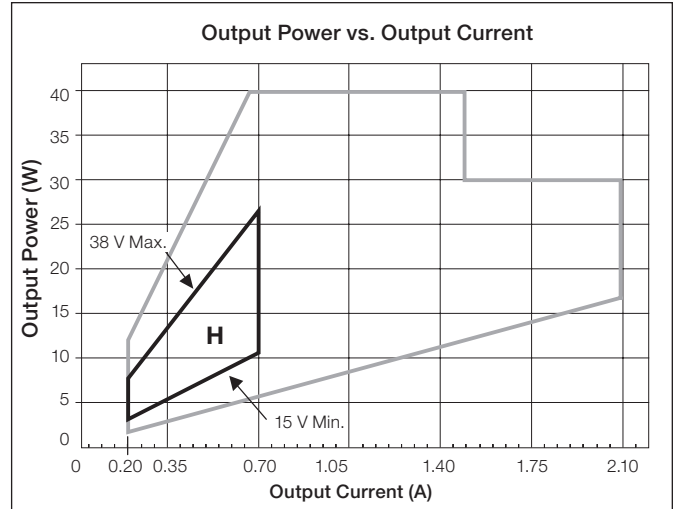
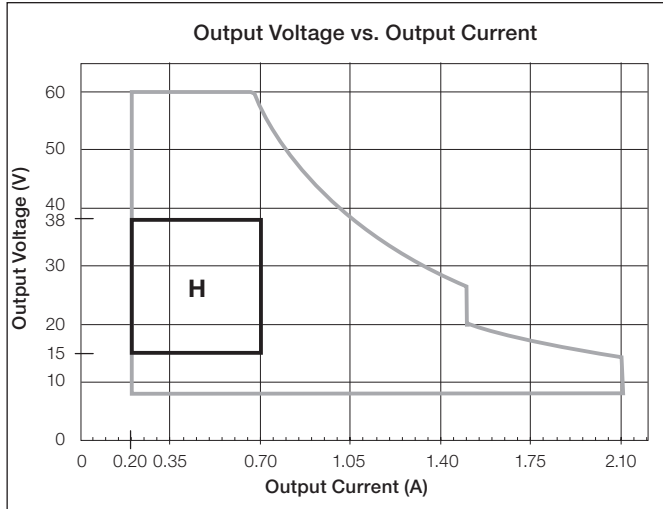

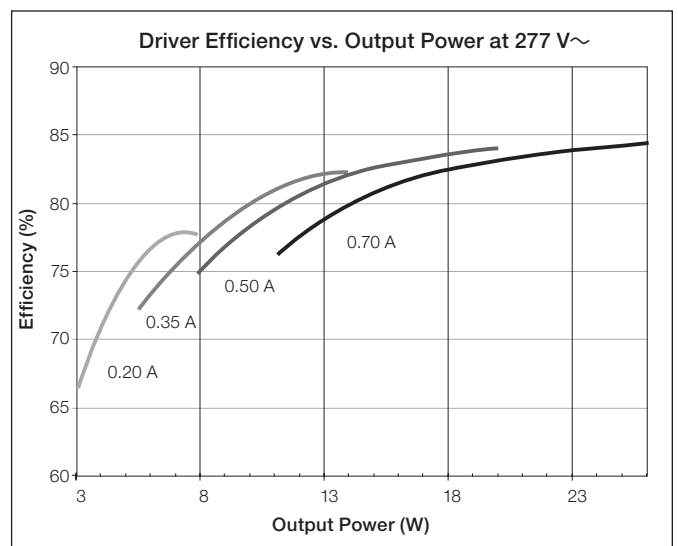
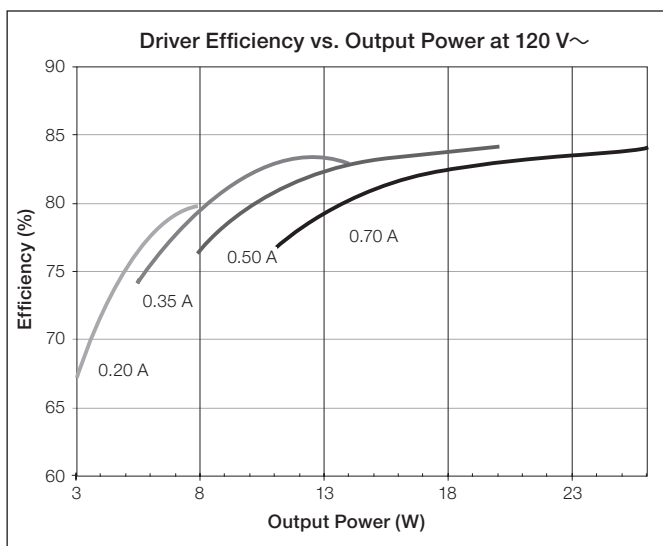

Typical Performance Specifications:

Parameter	120 V~	240 V~	277 V~	Test Conditions
Input Current	270 mA	140 mA	120 mA	t _a = 25 °C, 0.70 A 26 W load, Maximum Light Output, K-case
Power Factor	0.99	0.96	0.94	
THD	7%	10%	12%	
Driver Efficiency	84%	85%	85%	



Job Name:	Model Numbers:
Job Number:	

“I” Output Range, Current Driver Models

Driver Type	Output Dimming Method	Output Voltage	Output Current	Output Power	Standards Recognition	KL Case Option	Standards Recognition for KL Case
Constant-Current Driver (Class 2)	Pulse Width Modulation (PWM)	8–20 V PWM	0.71–1.05 A	6–21 W	 Type TL 86 °/63 °C - K-case Type TL 89 °/68 °C - M-case	Yes	
	Constant-Current Reduction (CCR)	8–20 V=					

When using QwikFig technology, these models can be built from the following bulk units:

K-case - L3DA4U1UKx-2RBLK*; M-case - L3DA4U1UMN-2CBLK

* x = studded (S) or non-studded (N)

Current Driver Operation Range:

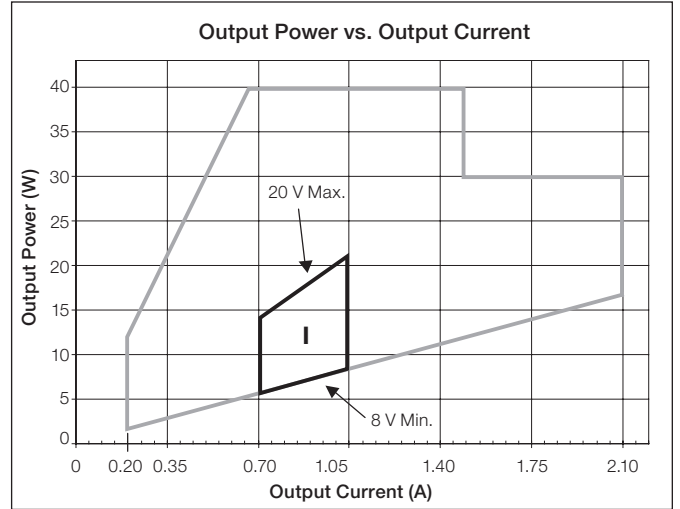
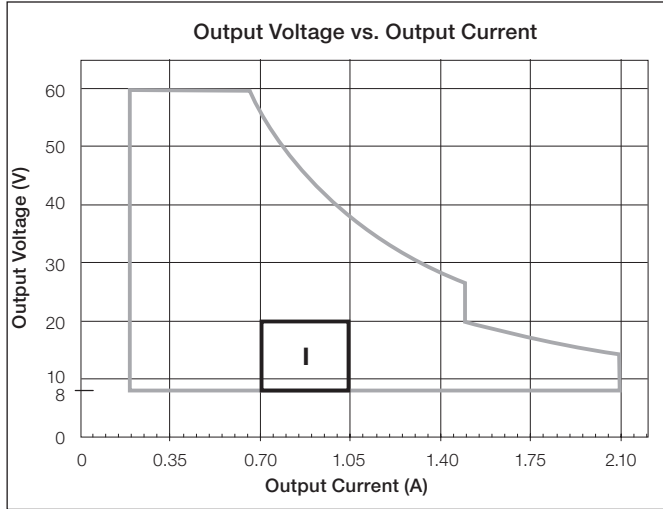

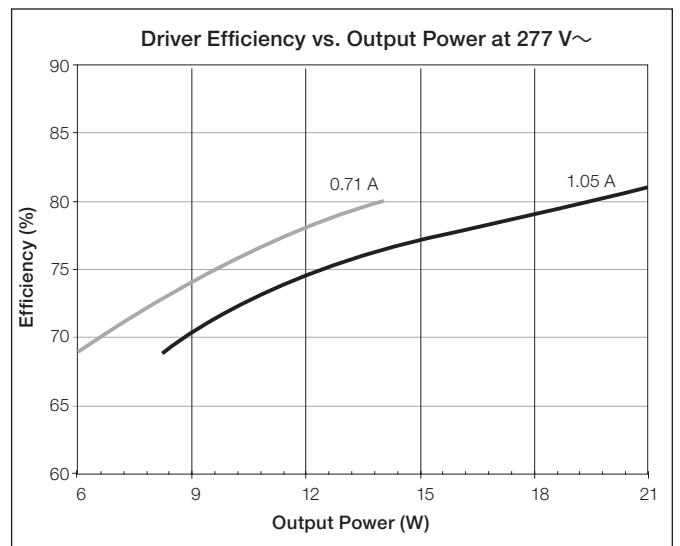
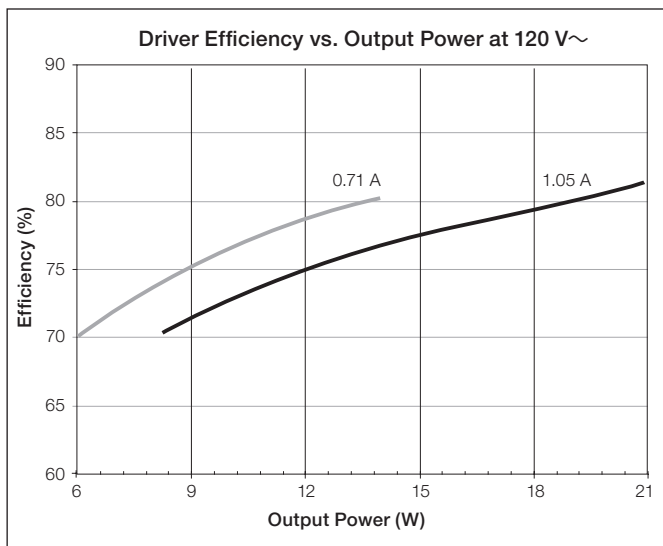

Typical Performance Specifications:

Parameter	120 V~	240 V~	277 V~	Test Conditions
Input Current	210 mA	120 mA	100 mA	t _a = 25 °C, 1.05 A 21 W load, Maximum Light Output, K-case
Power Factor	0.98	0.94	0.92	
THD	15%	13%	14%	
Driver Efficiency	82%	81%	81%	



Job Name:	Model Numbers:
Job Number:	

“J” Output Range, Current Driver Models

Driver Type	Output Dimming Method	Output Voltage	Output Current	Output Power	Standards Recognition	KL Case Option	Standards Recognition for KL Case
Constant-Current Driver (Class 2)	Pulse Width Modulation (PWM)	15–38 V PWM	0.71–1.05 A	11–40 W	 Type TL 86 °/69 °C - K-case Type TL 89 °/74 °C - M-case	Yes	
	Constant-Current Reduction (CCR)	15–38 V---					

When using QwikFig technology, these models can be built from the following bulk units:

K-case - L3DA4U1UKx-2SBLK*; M-case - L3DA4U1UMN-2BBLK

* x = studded (S) or non-studded (N)

Current Driver Operation Range:

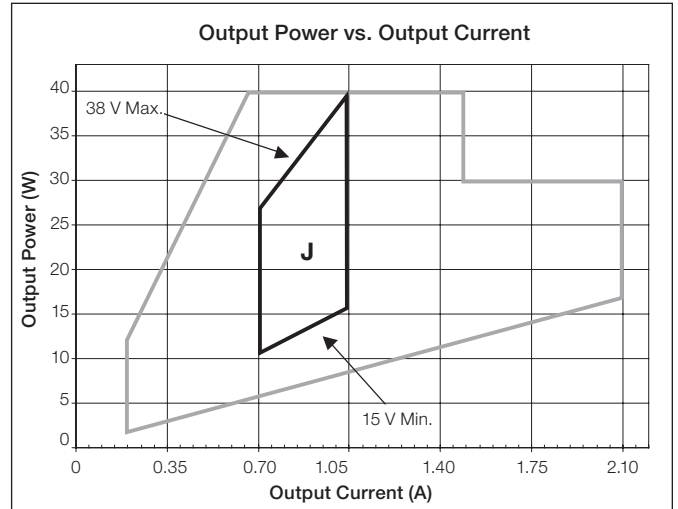
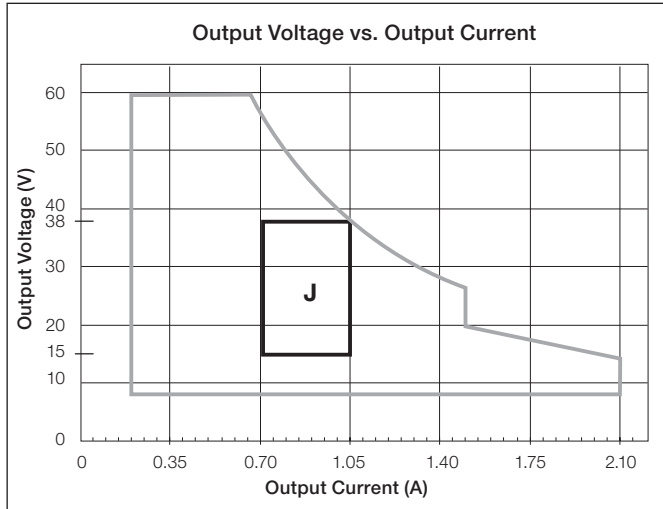

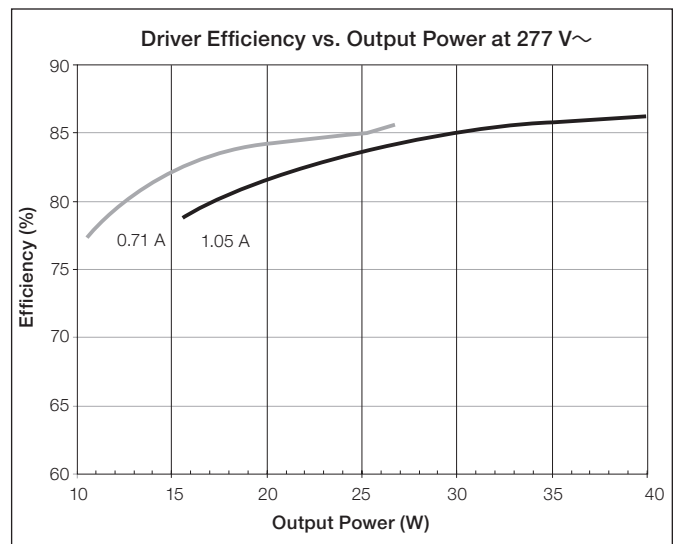
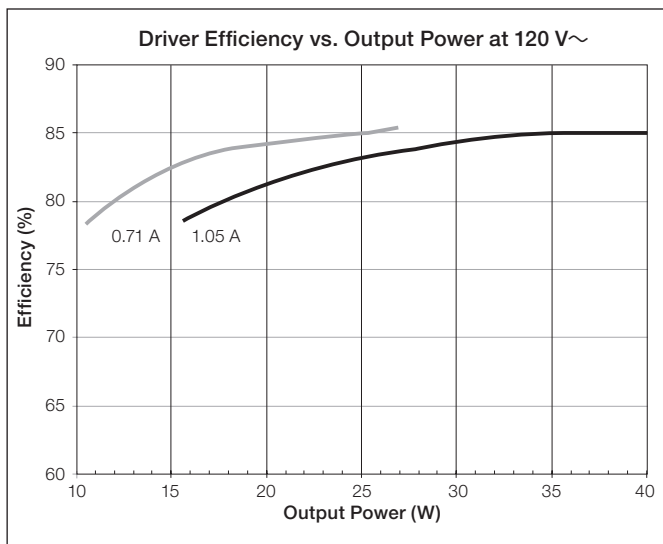

Typical Performance Specifications:

Parameter	120 V~	240 V~	277 V~	Test Conditions
Input Current	390 mA	200 mA	170 mA	t _a = 25 °C, 1.05 A 40 W load, Maximum Light Output, K-case
Power Factor	0.99	0.98	0.97	
THD	6%	9%	10%	
Driver Efficiency	85%	86%	86%	



Job Name:	Model Numbers:
Job Number:	

“K” Output Range, Current Driver Models

Driver Type	Output Dimming Method	Output Voltage	Output Current	Output Power	Standards Recognition	KL Case Option	Standards Recognition for KL Case
Constant-Current Driver (Class 2)	Pulse Width Modulation (PWM)	8–20 V PWM	1.06–1.50 A	9–30 W	 Type TL 86 °/63 °C - K-case Type TL 89 °/68 °C - M-case	Yes	
	Constant-Current Reduction (CCR)	8–20 V=					

When using QwikFig technology, these models can be built from the following bulk units:

K-case - L3DA4U1UKx-2RBLK*; M-case - L3DA4U1UMN-2CBLK

* x = studded (S) or non-studded (N)

Current Driver Operation Range:

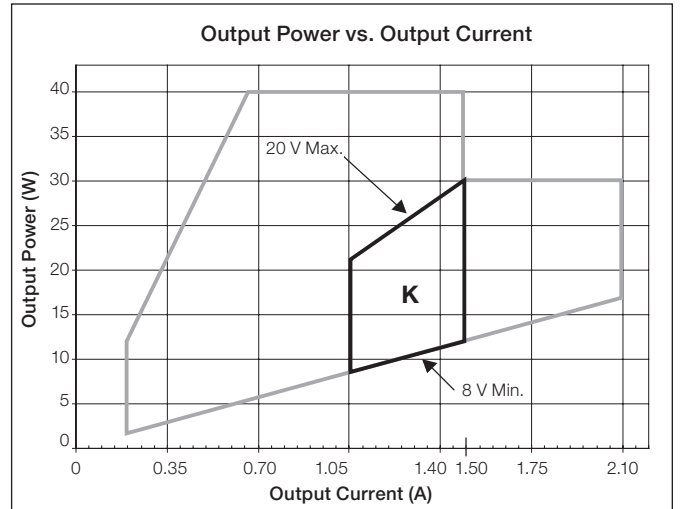
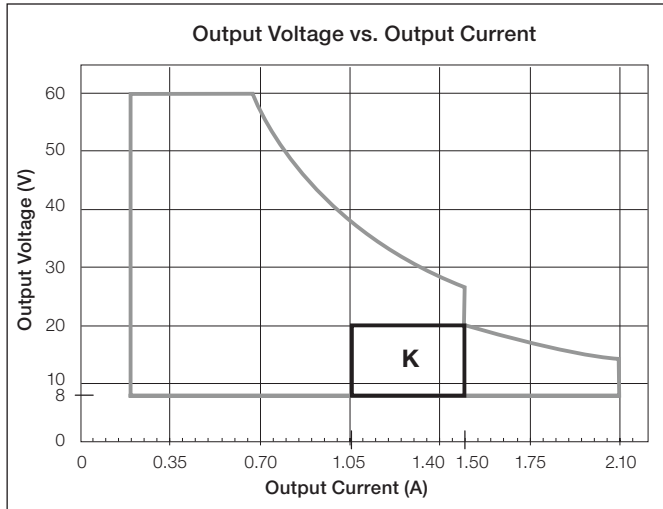

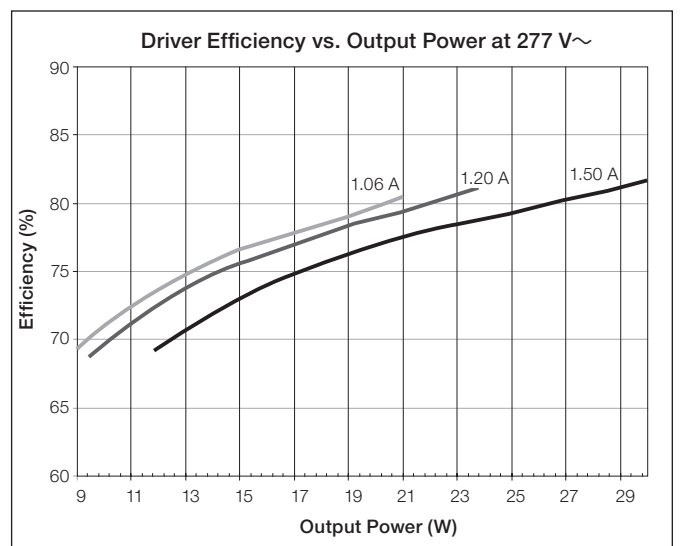
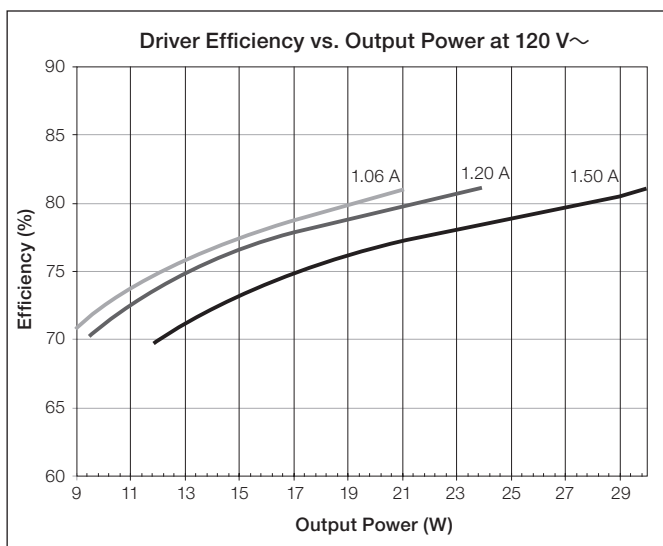

Typical Performance Specifications:

Parameter	120 V~	240 V~	277 V~	Test Conditions
Input Current	310 mA	160 mA	130 mA	t _a = 25 °C, 1.50 A 30 W load, Maximum Light Output, K-case
Power Factor	0.99	0.96	0.94	
THD	15%	17%	15%	
Driver Efficiency	81%	83%	82%	



Job Name:	Model Numbers:
Job Number:	

“L” Output Range, Current Driver Models

Driver Type	Output Dimming Method	Output Voltage	Output Current	Output Power	Standards Recognition	KL Case Option	Standards Recognition for KL Case
Constant-Current Driver (Class 2)	Pulse Width Modulation (PWM)	15–38 V PWM	1.06–1.50 A	16–40 W	 Type TL 86 °/69 °C - K-case Type TL 89 °/74 °C - M-case	Yes	
	Constant-Current Reduction (CCR)	15–38 V---					

When using QwikFig technology, these models can be built from the following bulk units:

K-case - L3DA4U1UKx-2SBLK**; M-case - L3DA4U1UMN-2BBLK

* Output parameter is power-limited for this output range. Consult detailed specifications on this page for the minimum and maximum voltage for each operating current.

** x = studded (S) or non-studded (N)

Current Driver Operation Range:

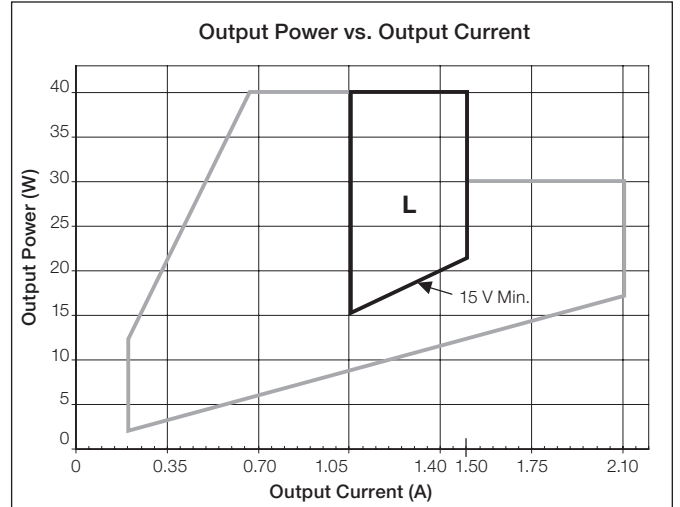
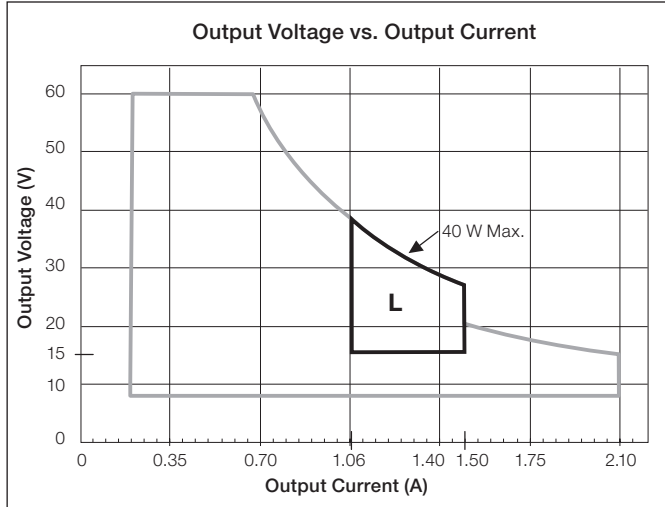

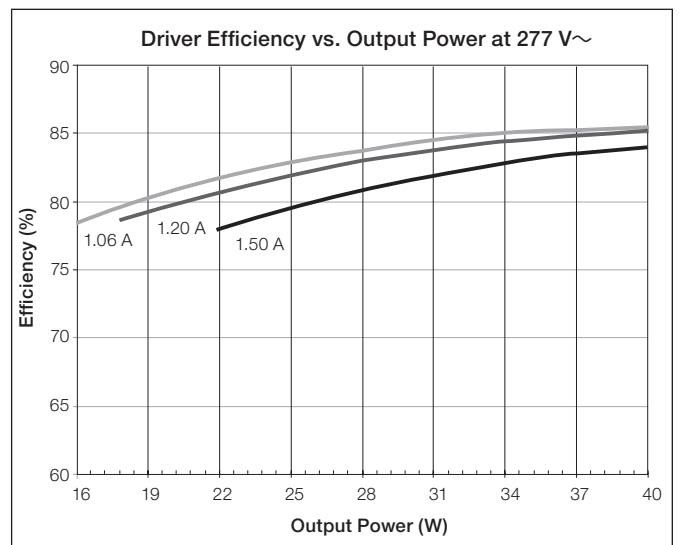
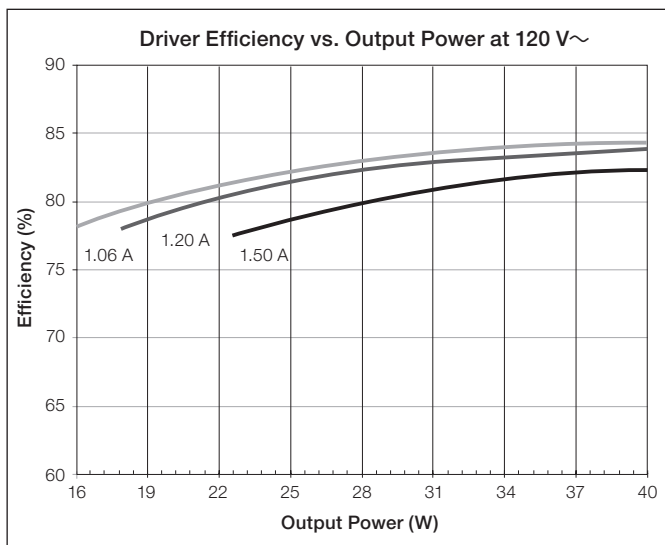

Typical Performance Specifications:

Parameter	120 V~	240 V~	277 V~	Test Conditions
Input Current	390 mA	200 mA	180 mA	t _a = 25 °C, 1.50 A 40 W load, Maximum Light Output, K-case
Power Factor	0.99	0.97	0.96	
THD	9%	13%	12%	
Driver Efficiency	83%	85%	85%	



Job Name:	Model Numbers:
Job Number:	

“M” Output Range, Current Driver Models

Driver Type	Output Dimming Method	Output Voltage	Output Current	Output Power	Standards Recognition	KL Case Option	Standards Recognition for KL Case
Constant-Current Driver (Class 2)	Pulse Width Modulation (PWM)	8–19.9 V PWM	1.51–2.10 A	12–30 W	 Type TL 89 °/67 °C - K-case Type TL 89 °/71 °C - M-case	Yes	
	Constant-Current Reduction (CCR)	8–19.9 V $\overline{=}$ *					

When using QwikFig technology, these models can be built from the following bulk units:

K-case - L3DA4U1UKx-2ABLK**; M-case - L3DA4U1UMN-2ABLK

* Output parameter is power-limited for this output range. Consult detailed specifications on this page for the minimum and maximum voltage for each operating current.

** x = studded (S) or non-studded (N)

Current Driver Operation Range:

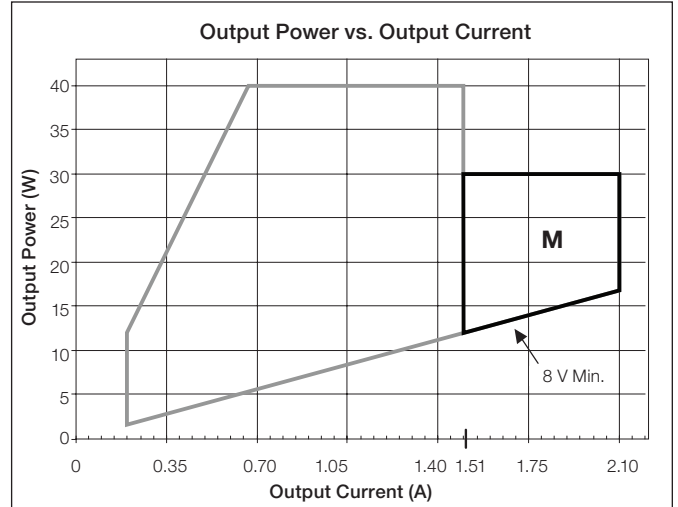
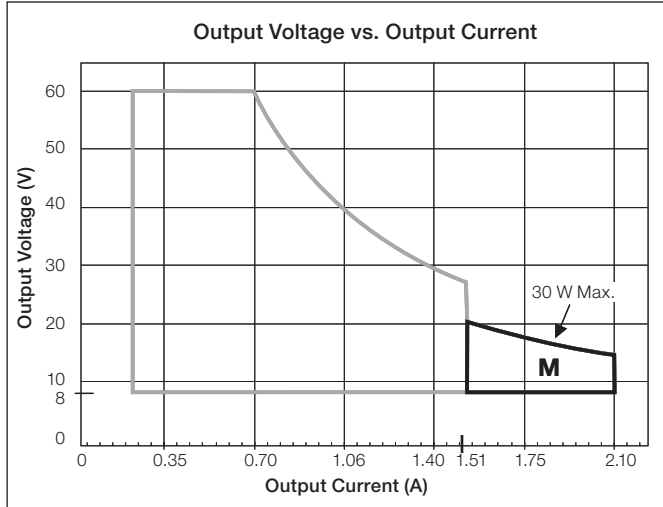

Typical Performance Specifications:

Parameter	120 V \sim	240 V \sim	277 V \sim	Test Conditions
Input Current	310 mA	160 mA	140 mA	$t_a = 25\text{ }^\circ\text{C}$, 2.10 A 30 W load, Maximum Light Output, K-case
Power Factor	0.99	0.97	0.95	
THD	12%	12%	12%	
Driver Efficiency	80%	81%	81%	

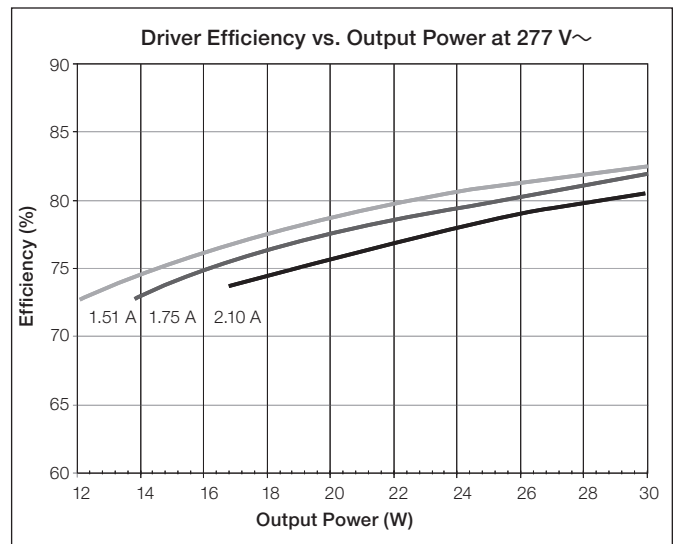
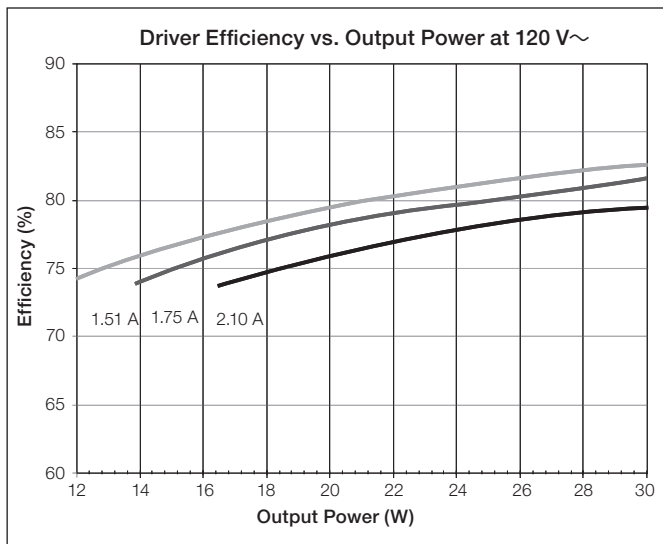

Job Name:	Model Numbers:
Job Number:	

“N” Output Range, Current Driver Models

Driver Type	Output Dimming Method	Output Voltage	Output Current	Output Power	Standards Recognition	KL Case Option
Constant-Current Driver (Class 2)	Constant-Current Reduction (CCR)	35–54 V***	0.71–1.05 A	25–53 W	 Type TL 87 °/71 °C - K-case	No

When using QwikFig technology, these models can be built from the following bulk unit:
K-case - L3DA5U1UKx-3BBLK**

- * Output parameter is power-limited for this output range. Consult detailed specifications on this page for the minimum and maximum voltage for each operating current.
- ** x = studded (S) or non-studded (N)

Current Driver Operation Range:

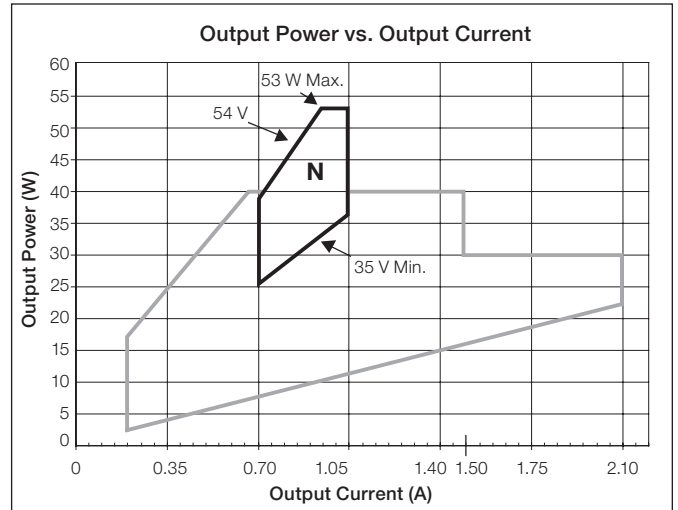
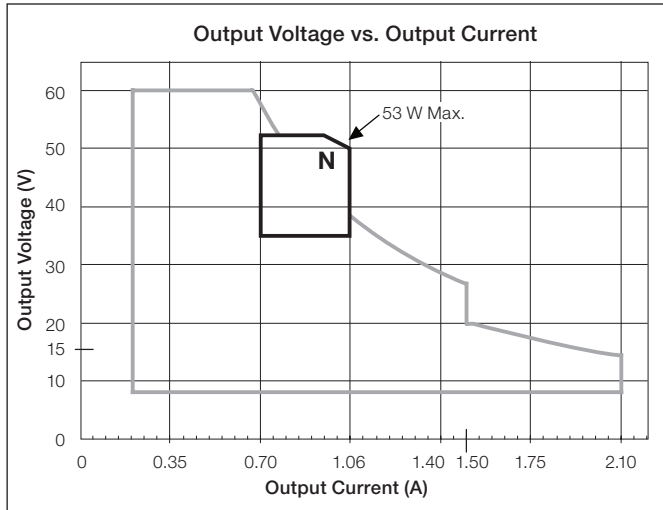

Typical Performance Specifications:

Parameter	120 V~	240 V~	277 V~	Test Conditions
Input Current	510 mA	255 mA	220 mA	t _a = 25 °C, 1.05 A 53 W load, Maximum Light Output, K-case
Power Factor	1.00	0.99	0.99	
THD	12%	10%	10%	
Driver Efficiency	83%	84%	85%	

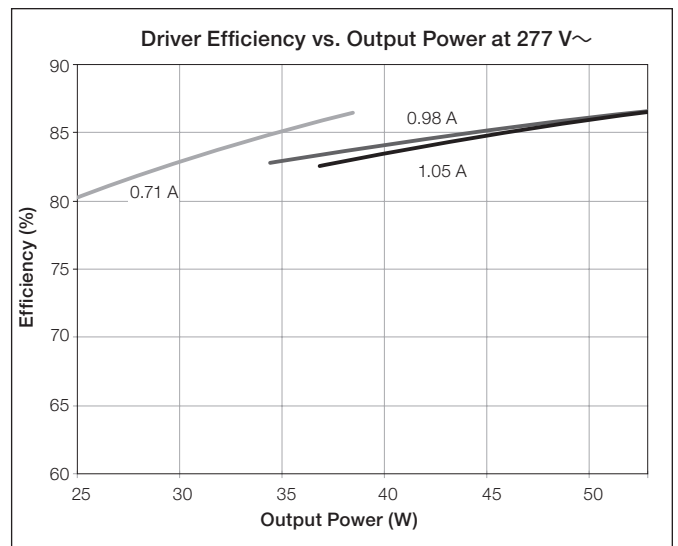
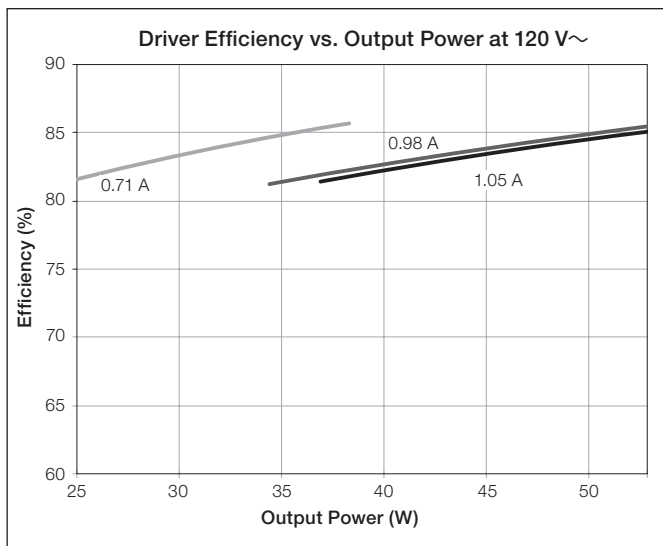

Job Name:	Model Numbers:
Job Number:	

“W” Output Range, Current Driver Models

Driver Type	Output Dimming Method	Output Voltage	Output Current	Output Power	Standards Recognition	KL Case Option
Constant-Current Driver (Isolated, Non-Class 2)	Pulse Width Modulation (PWM)	35–60 V PWM*	0.71–1.05 A	25–53 W	 Type TL 85 °/71 °C - K-case	No
	Constant-Current Reduction (CCR)	35–60 V==*				

When using QwikFig technology, these models can be built from the following bulk unit:

K-case - L3DA5U1UKx-1BBLK**

* Output parameter is power-limited for this output range. Consult detailed specifications on this page for the minimum and maximum voltage for each operating current.

** x = studded (S) or non-studded (N)

Current Driver Operation Range:

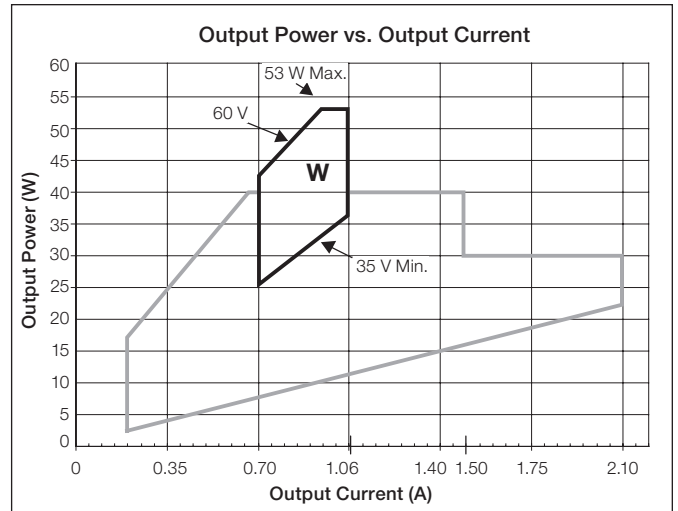
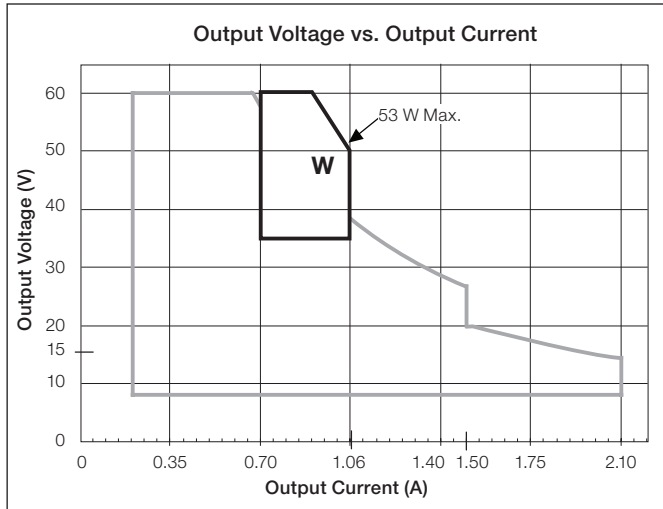

Typical Performance Specifications:

Parameter	120 V~	240 V~	277 V~	Test Conditions
Input Current	510 mA	255 mA	220 mA	t _a = 25 °C, 1.05 A 53 W load, Maximum Light Output, K-case
Power Factor	1.00	0.99	0.99	
THD	12%	10%	10%	
Driver Efficiency	83%	84%	85%	

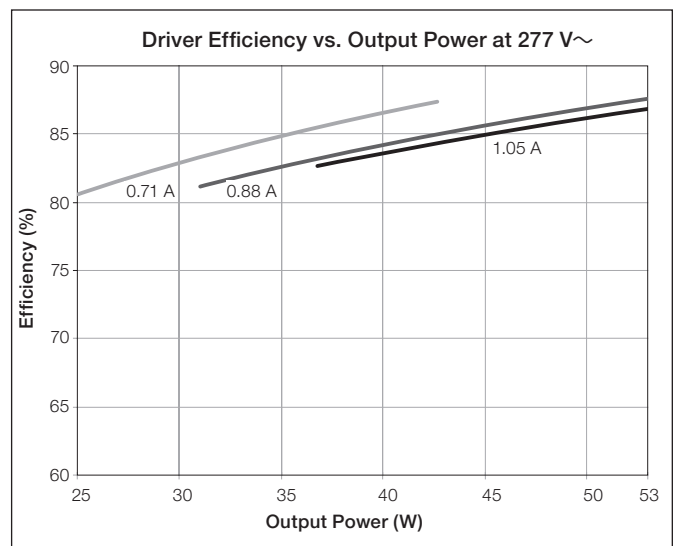
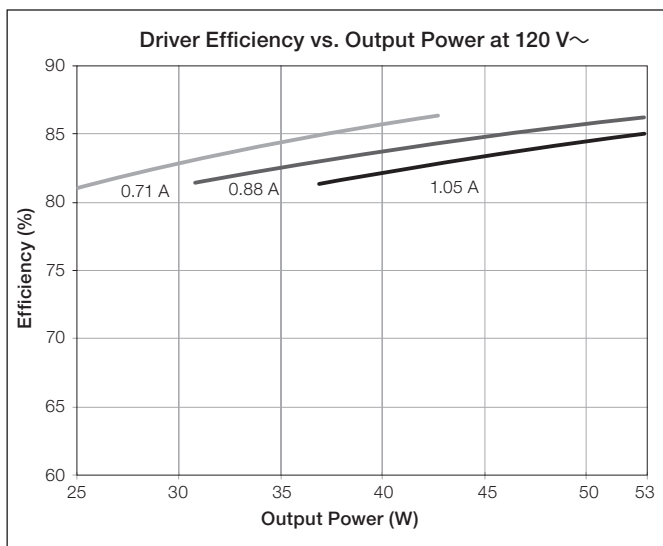

Job Name:	Model Numbers:
Job Number:	

“X” Output Range, Voltage Driver Models

Driver Type	Output Dimming Method	Output Voltage	Output Current	Output Power	Standards Recognition	KL Case Option
Constant-Voltage Driver (Isolated, Non-Class 2)	Pulse Width Modulation (PWM)	38.5 – 60.0 V PWM	0.08–1.04 A	5–40 W		No

Voltage Driver Operation Range:

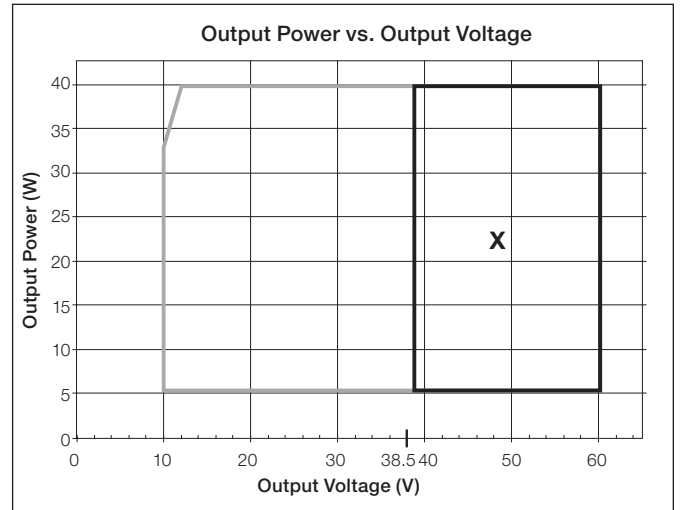
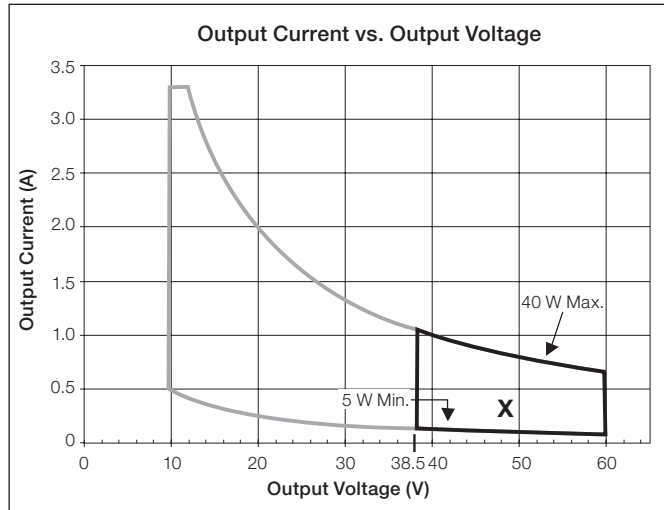

Typical Performance Specifications:

Parameter	120 V~	240 V~	277 V~	Test Conditions
Input Current	380 mA	190 mA	170 mA	t _a = 25 °C, 60.0 V 40 W load, Maximum Light Output, K-case
Power Factor	0.99	0.99	0.98	
THD	7%	6%	8%	
Driver Efficiency	88%	89%	89%	

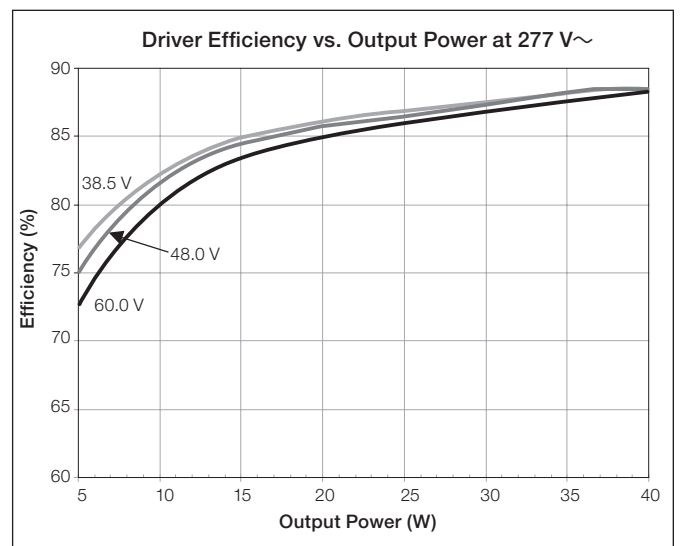
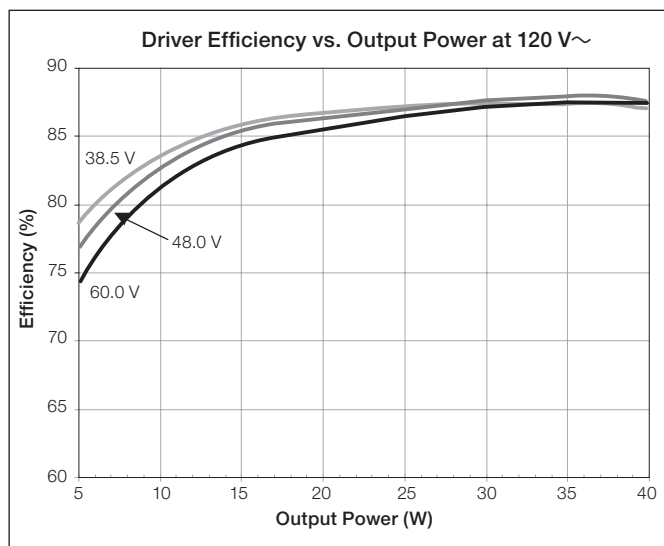

Job Name:	Model Numbers:
Job Number:	

“Y” Output Range, Current Driver Models

Driver Type	Output Dimming Method	Output Voltage	Output Current	Output Power	Standards Recognition	KL Case Option
Constant-Current Driver (Isolated, Non-Class 2)	Pulse Width Modulation (PWM)	30–60 V PWM	0.20–0.50 A	6–30 W	 Type TL 83 °/65 °C - K-case Type TL 89 °/72 °C - M-case	No
	Constant-Current Reduction (CCR)	30–60 V \approx				

When using QwikFig technology, these models can be built from the following bulk units:

K-case - L3DA4U1UKx-1ABLK*; M-case - L3DA4U1UMN-1ABLK

* x = studded (S) or non-studded (N)

Current Driver Operation Range:

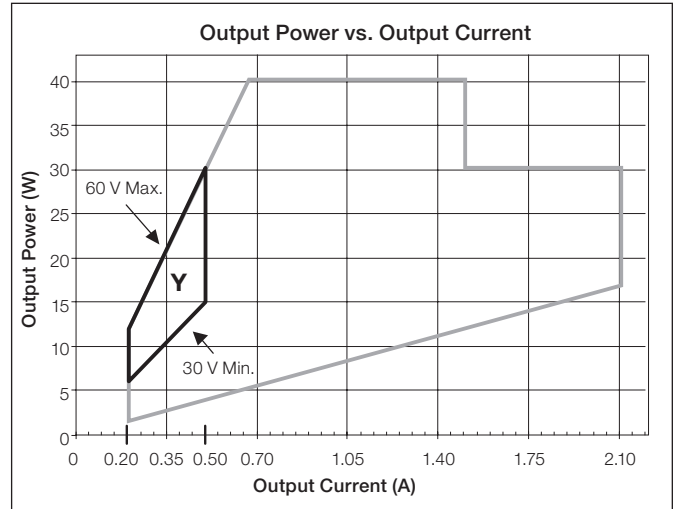
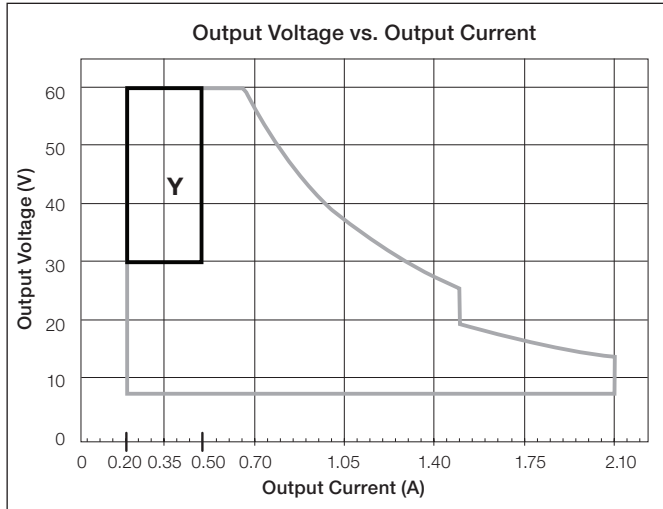

Typical Performance Specifications:

Parameter	120 V \sim	240 V \sim	277 V \sim	Test Conditions
Input Current	280 mA	150 mA	120 mA	t _a = 25 °C, 0.50 A 30 W load, Maximum Light Output, K-case
Power Factor	0.99	0.98	0.97	
THD	8%	9%	9%	
Driver Efficiency	85%	86%	86%	

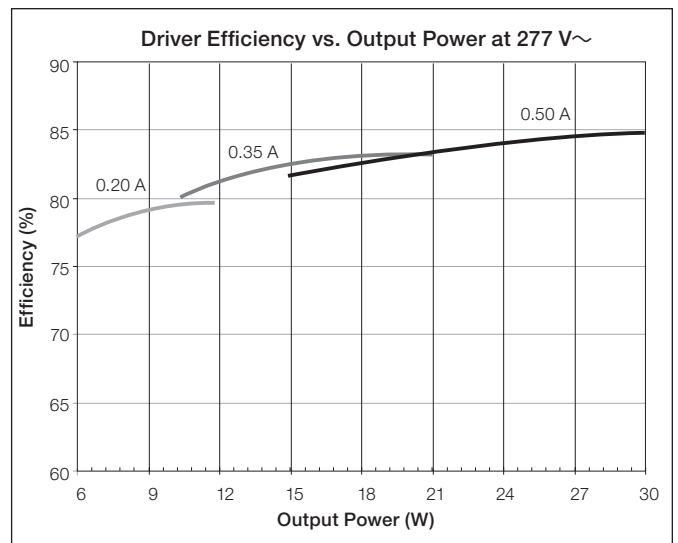
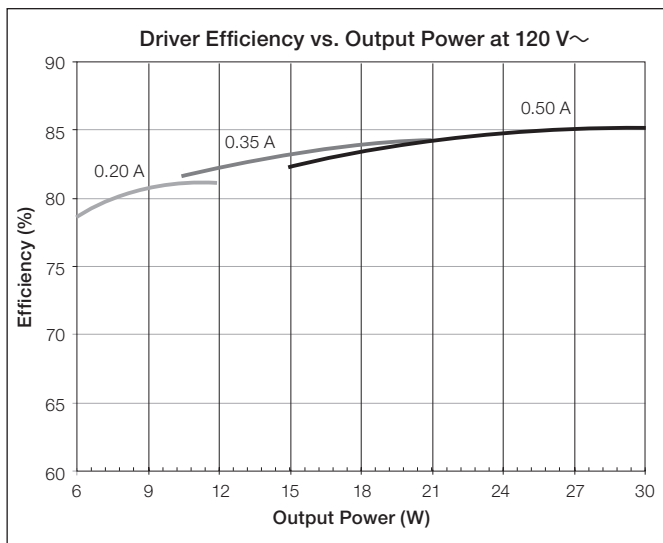

Job Name:	Model Numbers:
Job Number:	

“Z” Output Range, Current Driver Models

369325n 22 10.14.22

Driver Type	Output Dimming Method	Output Voltage	Output Current	Output Power	Standards Recognition	KL Case Option
Constant-Current Driver (Isolated, Non-Class 2)	Pulse Width Modulation (PWM)	30–60 V PWM*	0.51–1.00 A	16–40 W	 Type TL 83 °/65 °C - K-case Type TL 89 °/72 °C - M-case	No
	Constant-Current Reduction (CCR)	30–60 V---*				

When using QwikFig technology, these models can be built from the following bulk units:

K-case - L3DA4U1UKx-1ABLK**^{*}; M-case - L3DA4U1UMN-1ABLK

* Output parameter is power-limited for this output range. Consult detailed specifications on this page for the minimum and maximum voltage for each operating current.

** x = studded (S) or non-studded (N)

Current Driver Operation Range:

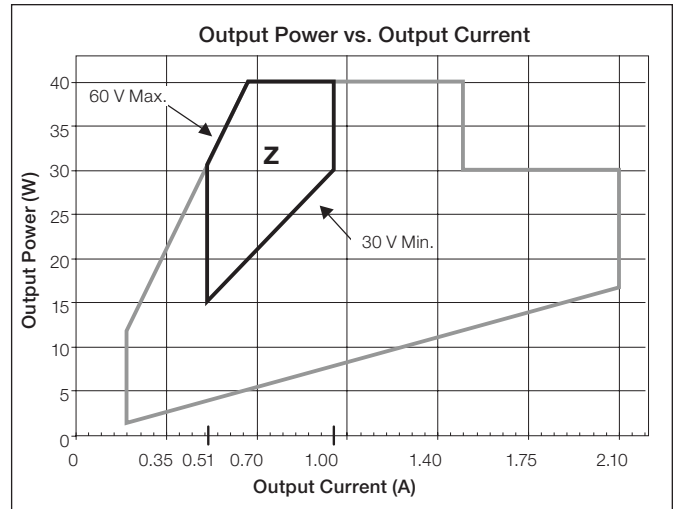
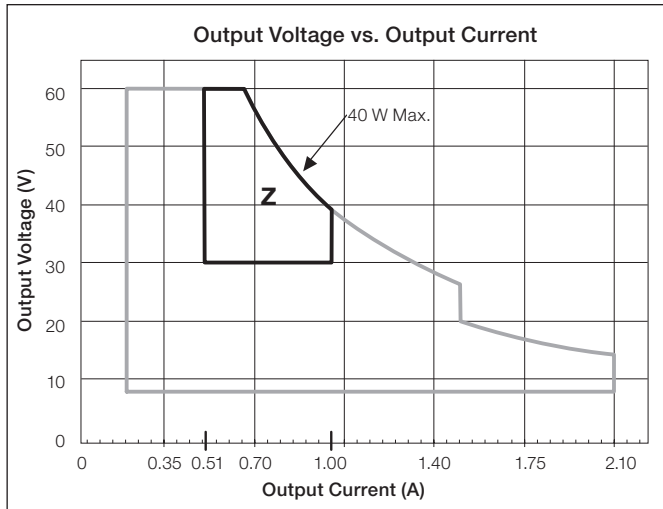

Typical Performance Specifications:

Parameter	120 V~	240 V~	277 V~	Test Conditions
Input Current	380 mA	200 mA	160 mA	t _a = 25 °C, 1.00 A 40 W load, Maximum Light Output, K-case
Power Factor	0.99	0.99	0.98	
THD	10%	8%	8%	
Driver Efficiency	84%	86%	86%	

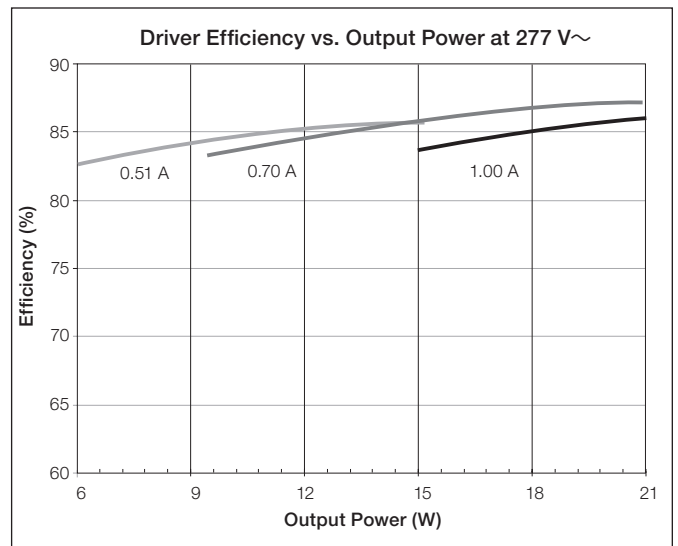
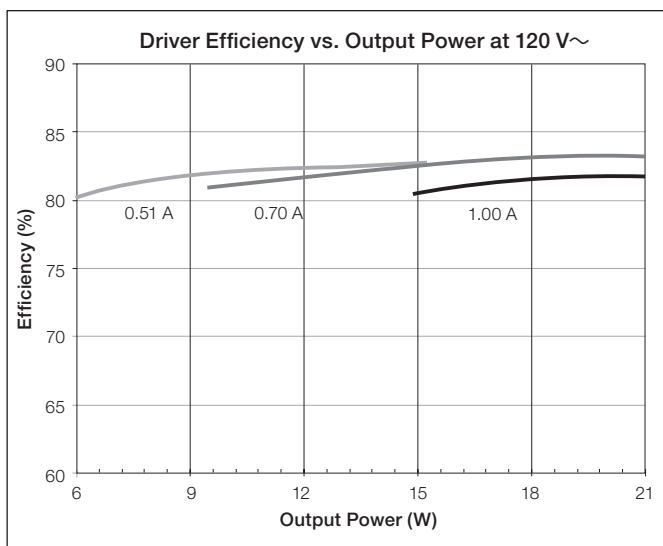

Job Name:	Model Numbers:
Job Number:	

Bulk Model Coverage - K-Case Model Numbers

For use with Lutron QwikFig technology

3ABLK Operation Range:

Bulk Model	Driver Type	Output Dimming Method	Output Voltage	Output Current	Output Power	Standards Recognition
3ABLK	Constant-Current Driver (Class 2)	Constant-Current Reduction (CCR)	30–54 V _{DC}	0.20–1.00 A	6–40 W	 Type TL 83 °/66 °C

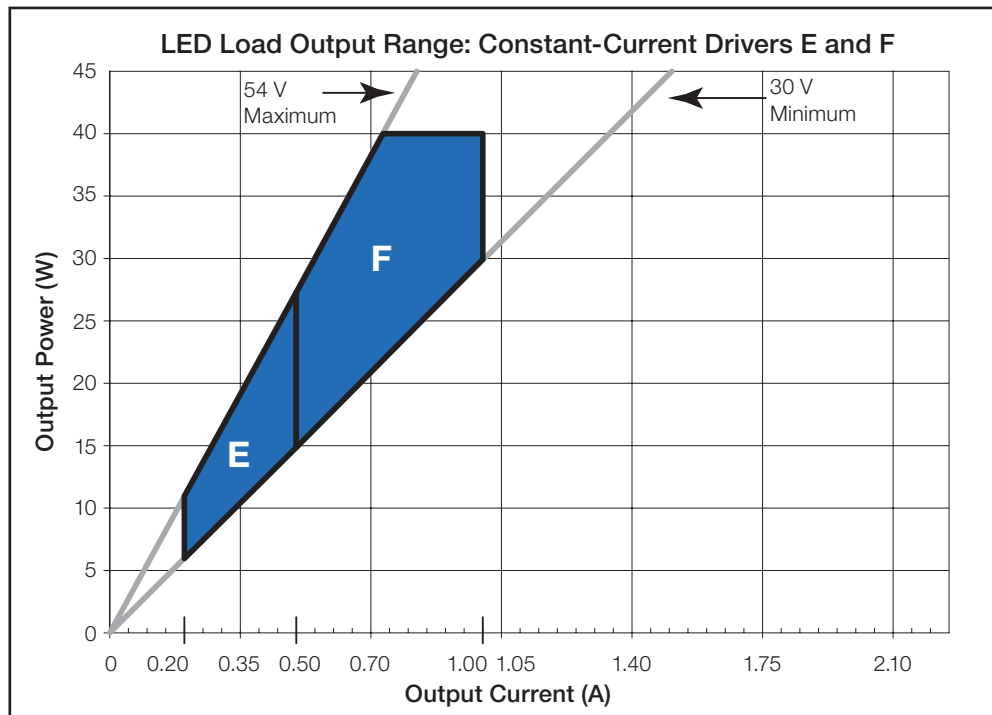



3A = Covers “LED Load Output Range” E and F (CCR dimming only)

Job Name:	Model Numbers:
Job Number:	

Bulk Model Coverage - K-Case Model Numbers (continued)
 For use with Lutron QwikFig technology

2HBLK and 2SBLK Operation Range:

Bulk Model	Driver Type	Output Dimming Method	Output Voltage	Output Current	Output Power	Standards Recognition
2HBLK	Constant-Current Driver (Class 2)	Pulse Width Modulation (PWM)	15–38 V PWM	0.20–0.70 A	3–26.6 W	 Type TL 89 °/61 °C
		Constant-Current Reduction (CCR)	15–38 V==			
2SBLK	Constant-Current Driver (Class 2)	Pulse Width Modulation (PWM)	15–38 V PWM*	0.71–1.50 A	11–40 W	 Type TL 86 °/69 °C
		Constant-Current Reduction (CCR)	15–38 V==*			

* Output parameter is power-limited for this output range. Consult detailed specifications on this page for the minimum and maximum voltage for each operating current.

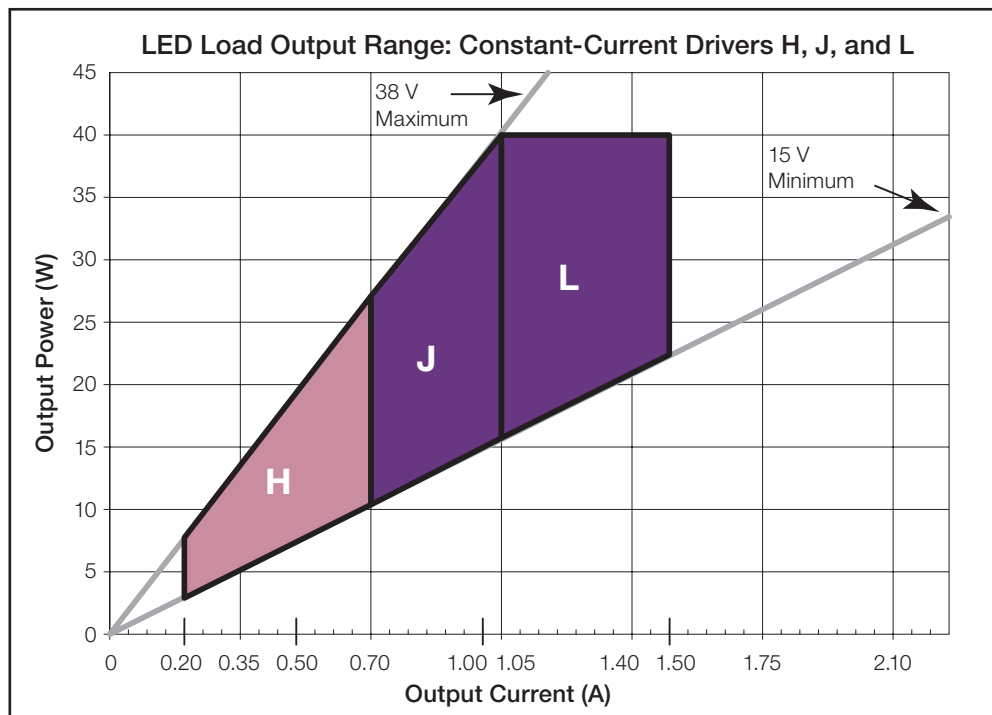



2H = Covers “LED Load Output Range” H
 2S = Covers “LED Load Output Range” J and L

Job Name:	Model Numbers:
Job Number:	

Bulk Model Coverage - K-Case Model Numbers (continued)
 For use with Lutron QwikFig technology

2GBLK, 2RBLK, and 2ABLK Operation Range:

Bulk Model	Driver Type	Output Dimming Method	Output Voltage	Output Current	Output Power	Standards Recognition
2GBLK	Constant-Current Driver (Class 2)	Pulse Width Modulation (PWM)	8–20 V PWM	0.20–0.70 A	2–14 W	 Type TL 87 °/55 °C
		Constant-Current Reduction (CCR)	8–20 V ⁻⁻⁻			
2RBLK	Constant-Current Driver (Class 2)	Pulse Width Modulation (PWM)	8–20 V PWM	0.71–1.50 A	6–30 W	 Type TL 86 °/63 °C
		Constant-Current Reduction (CCR)	8–20 V ⁻⁻⁻			
2ABLK	Constant-Current Driver (Class 2)	Pulse Width Modulation (PWM)	8–19.9 V PWM*	1.51–2.10 A	12–30 W	 Type TL 89 °/67 °C
		Constant-Current Reduction (CCR)	8–19.9 V ⁻⁻⁻ *			

* Output parameter is power-limited for this output range. Consult detailed specifications on this page for the minimum and maximum voltage for each operating current.

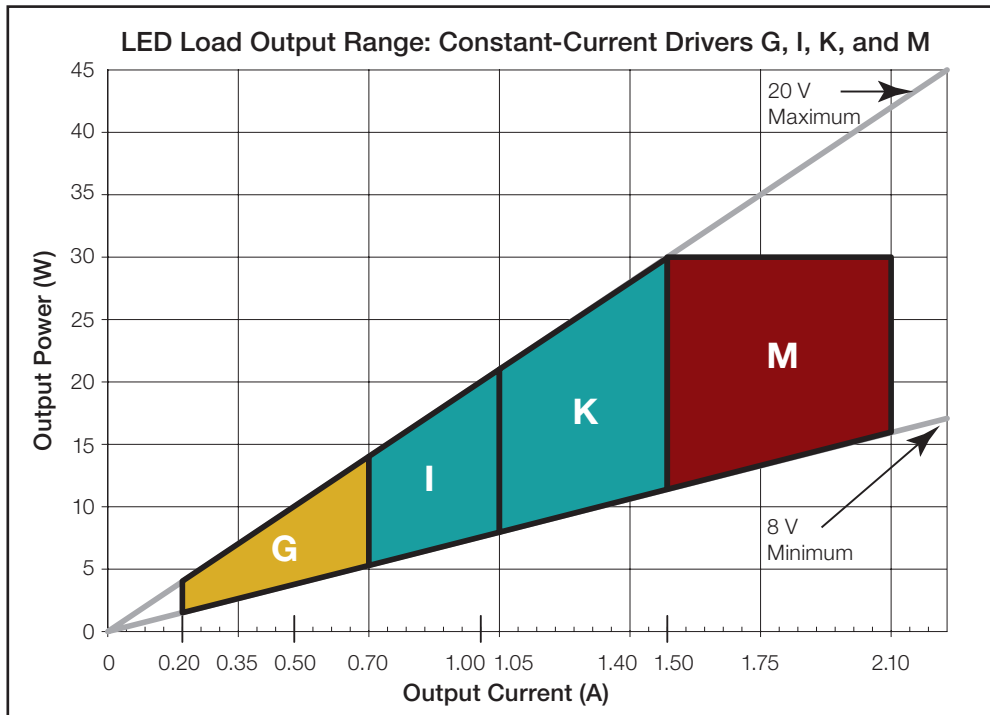

- 2G = Covers “LED Load Output Range” G
- 2R = Covers “LED Load Output Range” I and K
- 2A = Covers “LED Load Output Range” M

Job Name:	Model Numbers:
Job Number:	

Bulk Model Coverage - K-Case Model Numbers (continued)
 For use with Lutron QwikFig technology

1ABLK Operation Range:

Bulk Model	Driver Type	Output Dimming Method	Output Voltage	Output Current	Output Power	Standards Recognition
1ABLK	Constant-Current Driver (Isolated, Non-Class 2)	Pulse Width Modulation (PWM)	30–60 V PWM*	0.20–1.00 A	6–40 W	 Type TL 83 °/65 °C
		Constant-Current Reduction (CCR)	30–60 V==*			

* Output parameter is power-limited for this output range. Consult detailed specifications on this page for the minimum and maximum voltage for each operating current.

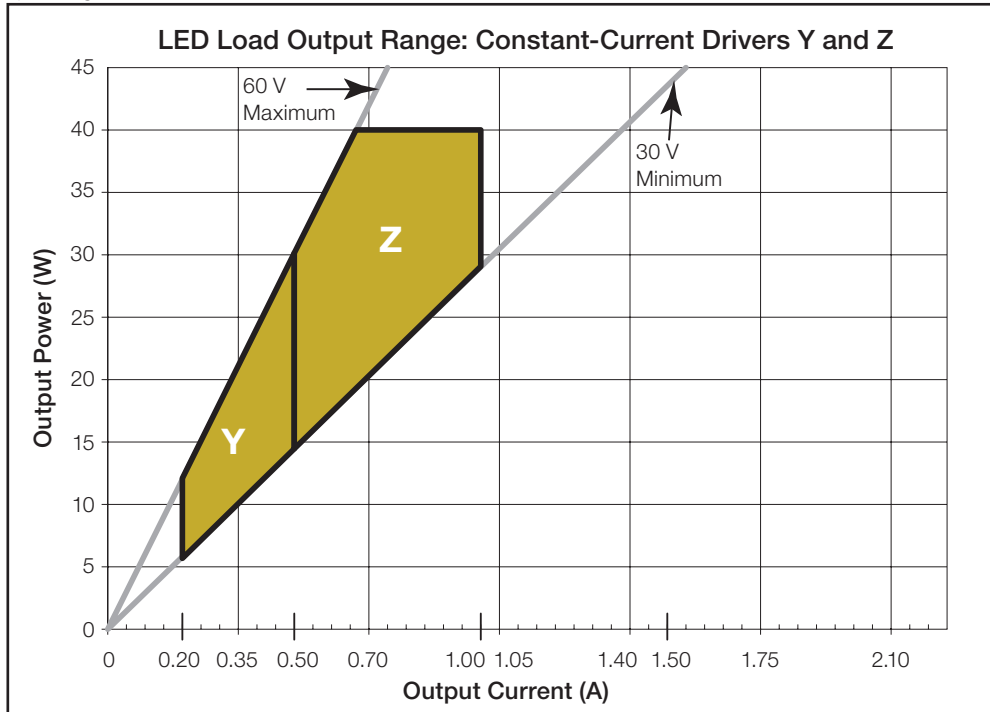

1A = Covers “LED Load Output Range” Y and Z

Job Name:	Model Numbers:
Job Number:	

Bulk Model Coverage - K-Case Model Numbers (continued)
 For use with Lutron QwikFig technology

3BBLK Operation Range:

Bulk Model	Driver Type	Output Dimming Method	Output Voltage	Output Current	Output Power	Standards Recognition
3BBLK	Constant-Current Driver (Class 2)	Constant-Current Reduction (CCR)	35–54 V ^{***}	0.71–1.05 A	25 –53 W	 Type TL 87 °/71 °C

* Output parameter is power-limited for this output range. Consult detailed specifications on this page for the minimum and maximum voltage for each operating current.

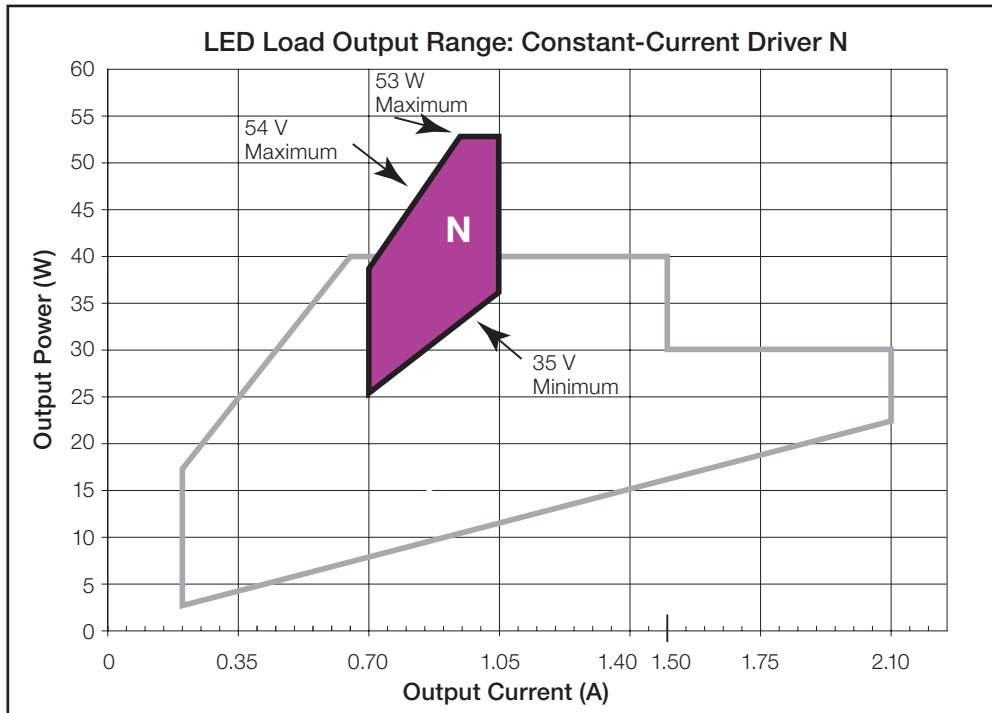

3B = Covers “LED Load Output Range” N

Job Name:	Model Numbers:
Job Number:	

Bulk Model Coverage - K-Case Model Numbers (continued)
 For use with Lutron QwikFig technology

1BBLK Operation Range:

Bulk Model	Driver Type	Output Dimming Method	Output Voltage	Output Current	Output Power	Standards Recognition
1BBLK	Constant-Current Driver (Isolated, Non-Class 2)	Pulse Width Modulation (PWM)	35–60 V PWM*	0.71–1.05 A	25–53 W	 Type TL 85 °/71 °C
		Constant-Current Reduction (CCR)	35–60 V==*			

* Output parameter is power-limited for this output range. Consult detailed specifications on this page for the minimum and maximum voltage for each operating current.

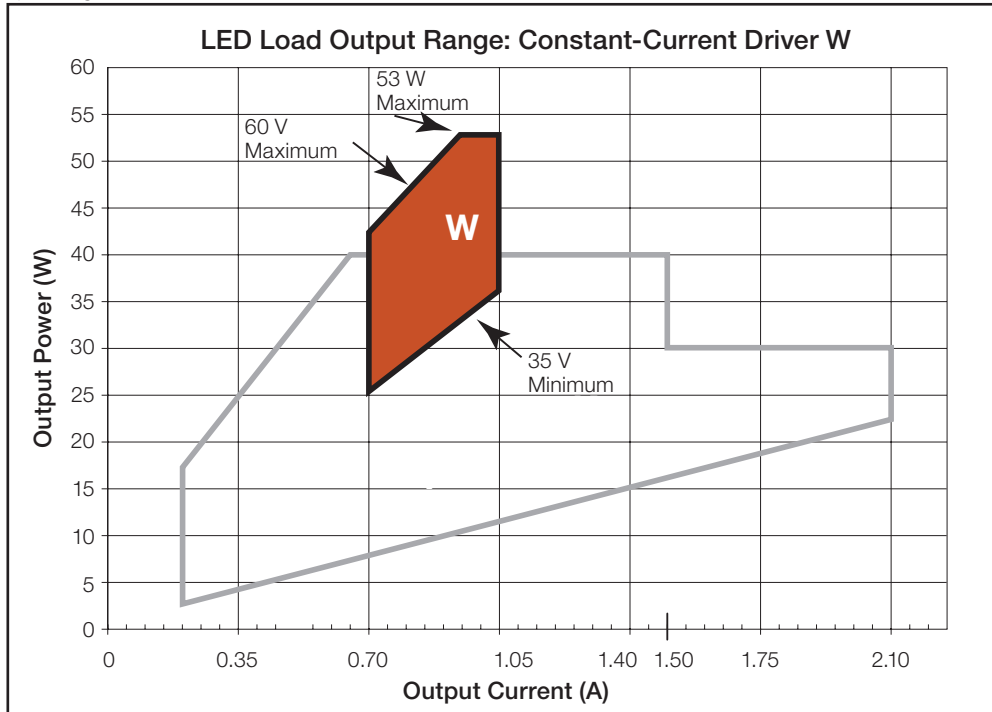

1B = Covers “LED Load Output Range” W

Job Name:	Model Numbers:
Job Number:	

Bulk Model Coverage - M-Case Model Numbers

For use with Lutron QwikFig technology

3ABLK Operation Range:

Bulk Model	Driver Type	Output Dimming Method	Output Voltage	Output Current	Output Power	Standards Recognition
3ABLK	Constant-Current Driver (Class 2)	Constant-Current Reduction (CCR)	30–54 V ^{***}	0.20–1.00 A	6–40 W	 Type TL 90 °/72 °C

* Output parameter is power-limited for this output range. Consult detailed specifications on this page for the minimum and maximum voltage for each operating current.

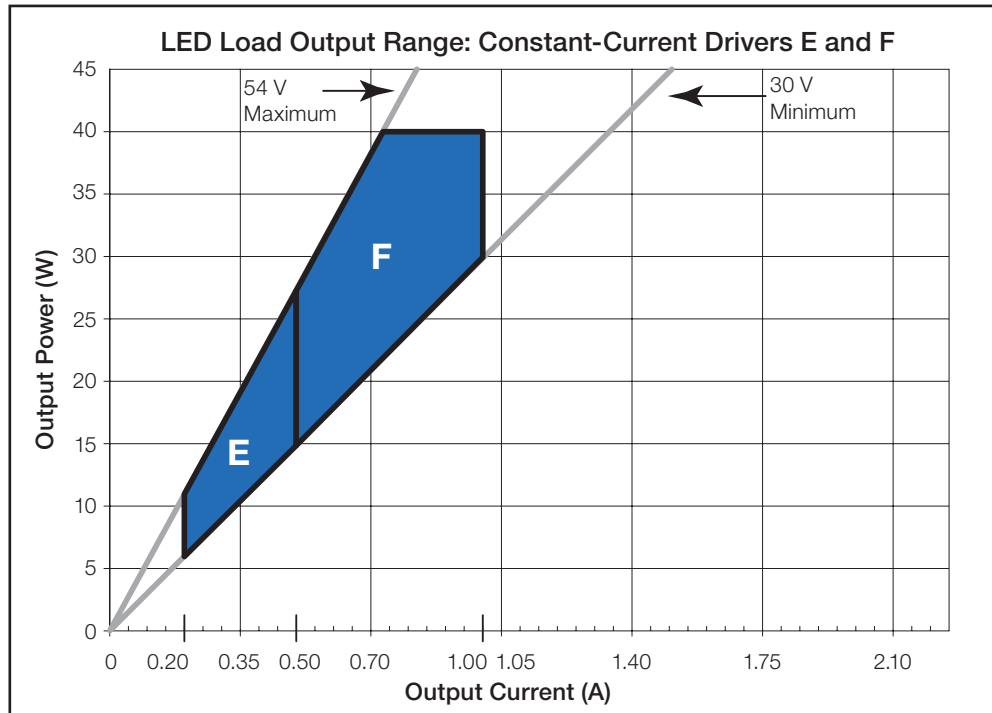

3A = Covers “LED Load Output Range” E and F (CCR dimming only)

Job Name:	Model Numbers:
Job Number:	

Bulk Model Coverage - M-Case Model Numbers (continued)
 For use with Lutron QwikFig technology

2BBLK Operation Range:

Bulk Model	Driver Type	Output Dimming Method	Output Voltage	Output Current	Output Power	Standards Recognition
2BBLK	Constant-Current Driver (Class 2)	Pulse Width Modulation (PWM)	15–38 V PWM*	0.20–1.50 A	3–40 W	 Type TL 89 °/74 °C
		Constant-Current Reduction (CCR)	15–38 V==*			

* Output parameter is power-limited for this output range. Consult detailed specifications on this page for the minimum and maximum voltage for each operating current.

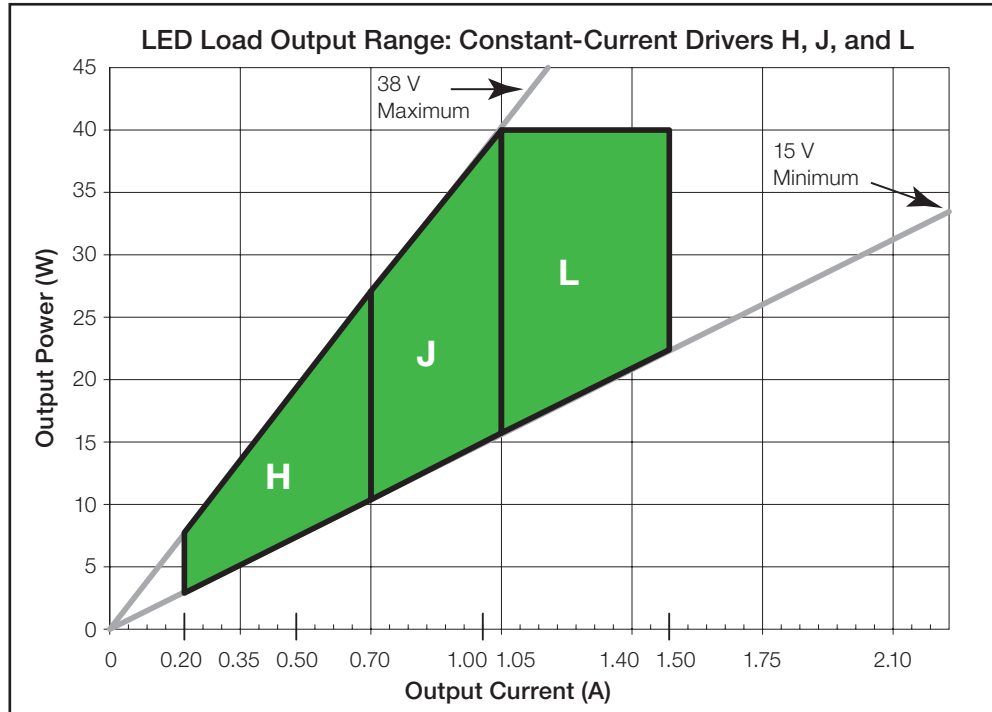



2B = Covers “LED Load Output Range” H, J, and L

Job Name:	Model Numbers:
Job Number:	

Bulk Model Coverage - M-Case Model Numbers (continued)
 For use with Lutron QwikFig technology

2CBLK and 2ABLK Operation Range:

Bulk Model	Driver Type	Output Dimming Method	Output Voltage	Output Current	Output Power	Standards Recognition
2CBLK	Constant-Current Driver (Class 2)	Pulse Width Modulation (PWM)	8–20 V PWM	0.20–1.50 A	2–30 W	 Type TL 89 °/68 °C
		Constant-Current Reduction (CCR)	8–20 V=			
2ABLK	Constant-Current Driver (Class 2)	Pulse Width Modulation (PWM)	8–19.9 V PWM*	1.51–2.10 A	12–30 W	 Type TL 89 °/71 °C
		Constant-Current Reduction (CCR)	8–19.9 V=*			

* Output parameter is power-limited for this output range. Consult detailed specifications on this page for the minimum and maximum voltage for each operating current.

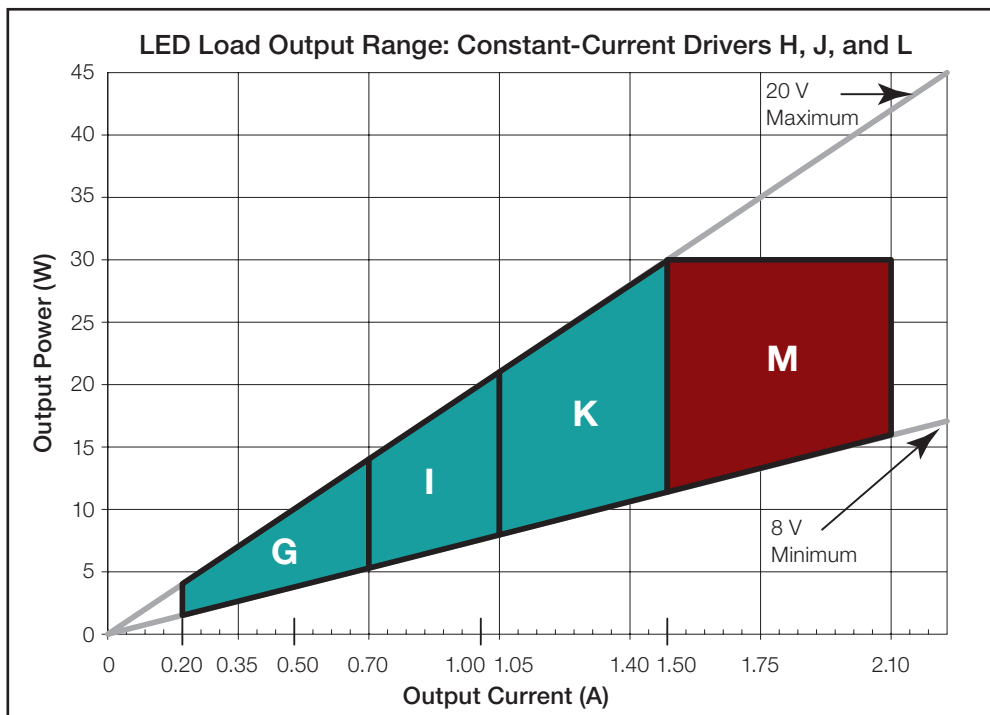

2C = Covers “LED Load Output Range” G, I, and K
 2A = Covers “LED Load Output Range” M

Job Name:	Model Numbers:
Job Number:	

Bulk Model Coverage - M-Case Model Numbers (continued)
 For use with Lutron QwikFig technology

1ABLK Operation Range:

Bulk Model	Driver Type	Output Dimming Method	Output Voltage	Output Current	Output Power	Standards Recognition
1ABLK	Constant-Current Driver (Isolated, Non-Class 2)	Pulse Width Modulation (PWM)	30–60 V PWM*	0.20–1.00 A	6–40 W	 Type TL 89 °/72 °C
		Constant-Current Reduction (CCR)	30–60 V==*			

* Output parameter is power-limited for this output range. Consult detailed specifications on this page for the minimum and maximum voltage for each operating current.

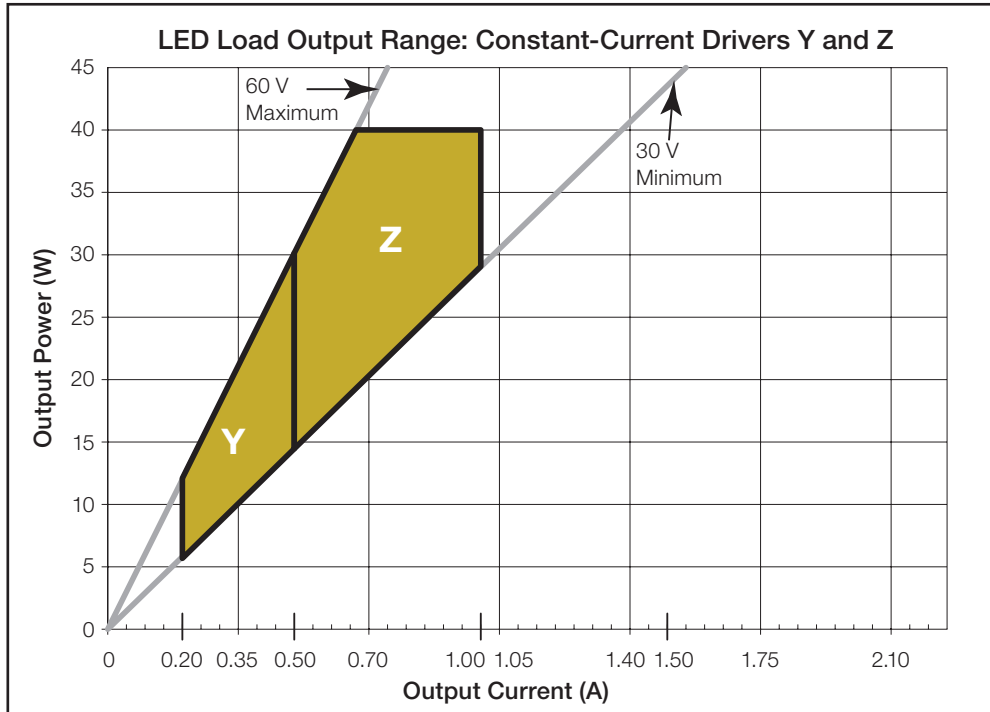

1A = Covers “LED Load Output Range” Y and Z

Job Name:	Model Numbers:
Job Number:	

K-Case: Case Dimensions

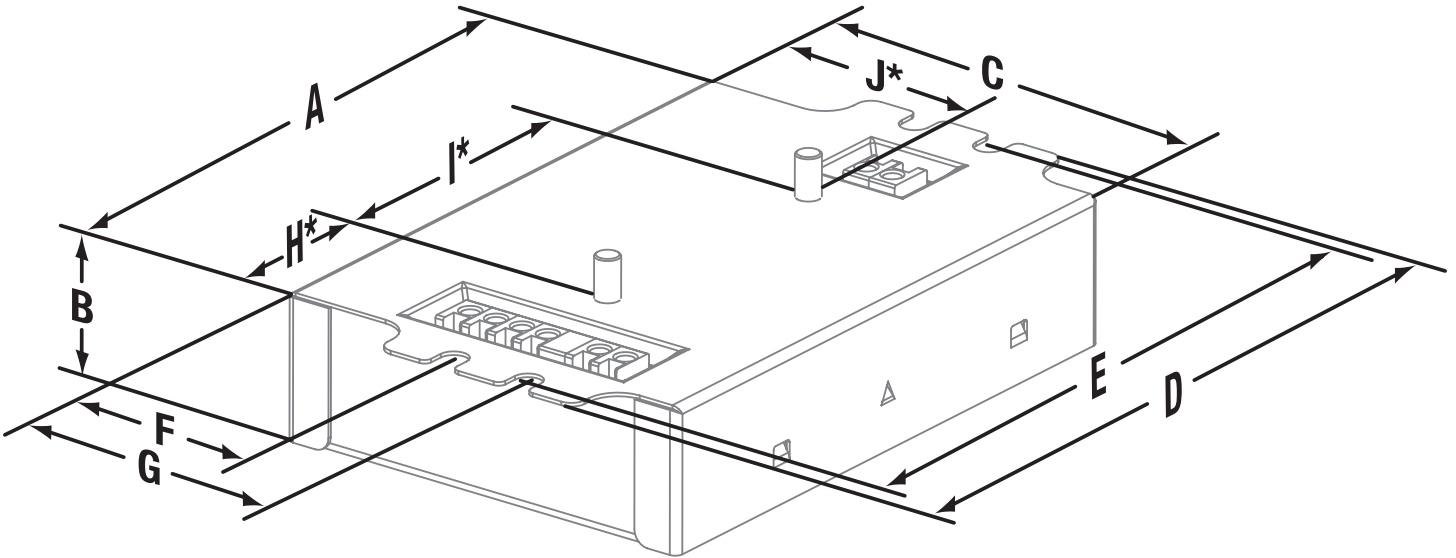

K-Case: Connector Location Dimensions

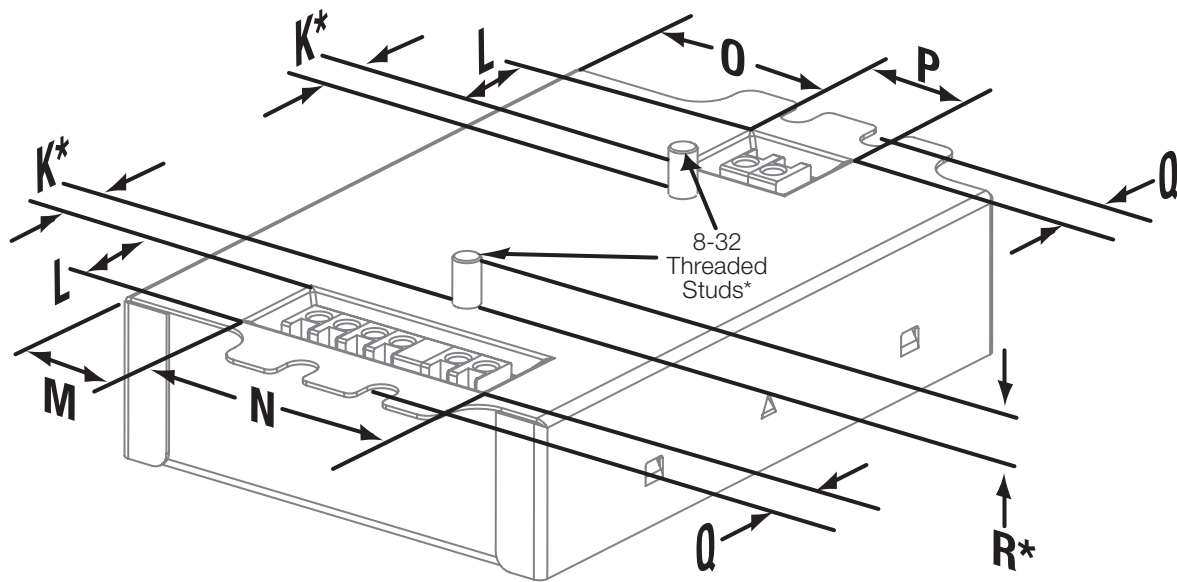

A	4.20 in (107 mm)	F	1.42 in (36 mm)	K*	0.33 in (8.3 mm)	P	0.74 in (19 mm)
B	1.00 in (25 mm)	G	1.99 in (51 mm)	L	0.65 in (16.5 mm)	Q	0.32 in (8 mm)
C	3.00 in (76 mm)	H*	1.11 in (28 mm)	M	0.75 in (19 mm)	R*	0.29 in (7 mm)
D	4.90 in (124 mm)	I*	2.00 in (51 mm)	N	1.73 in (44 mm)		
E	4.60 in (117 mm) (mounting center)	J*	1.60 in (41 mm)	O	1.33 in (34 mm)		

* Applies to studded K-case only.

LUTRON SPECIFICATION SUBMITTAL

Page

Job Name:	Model Numbers:
Job Number:	

K-Case: Side Entry Connector Location Dimensions (Non-Studded)

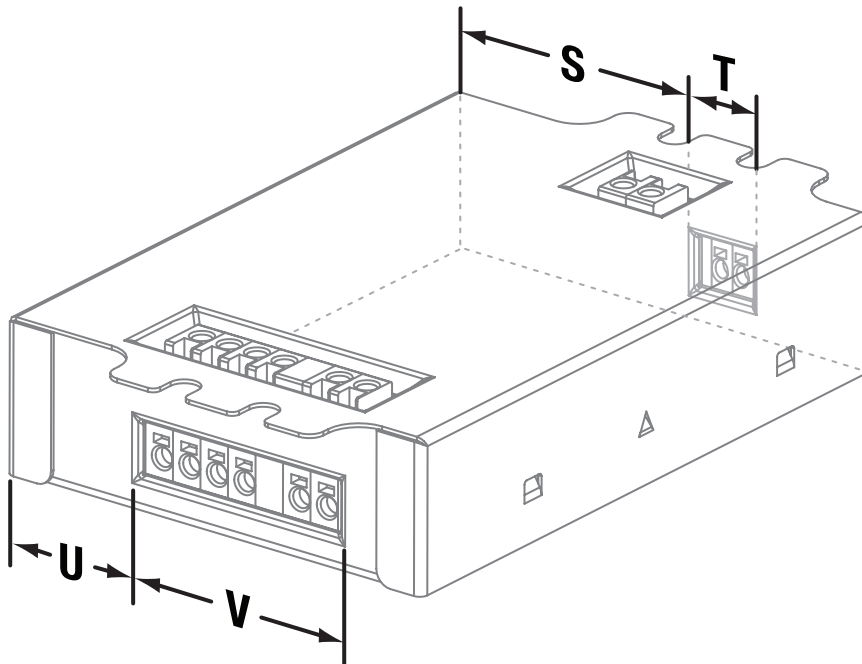

- S 1.38 in (35 mm)
- T 0.64 in (16 mm)
- U 0.88 in (22 mm)
- V 1.53 in (39 mm)

M-Case: Case Dimensions

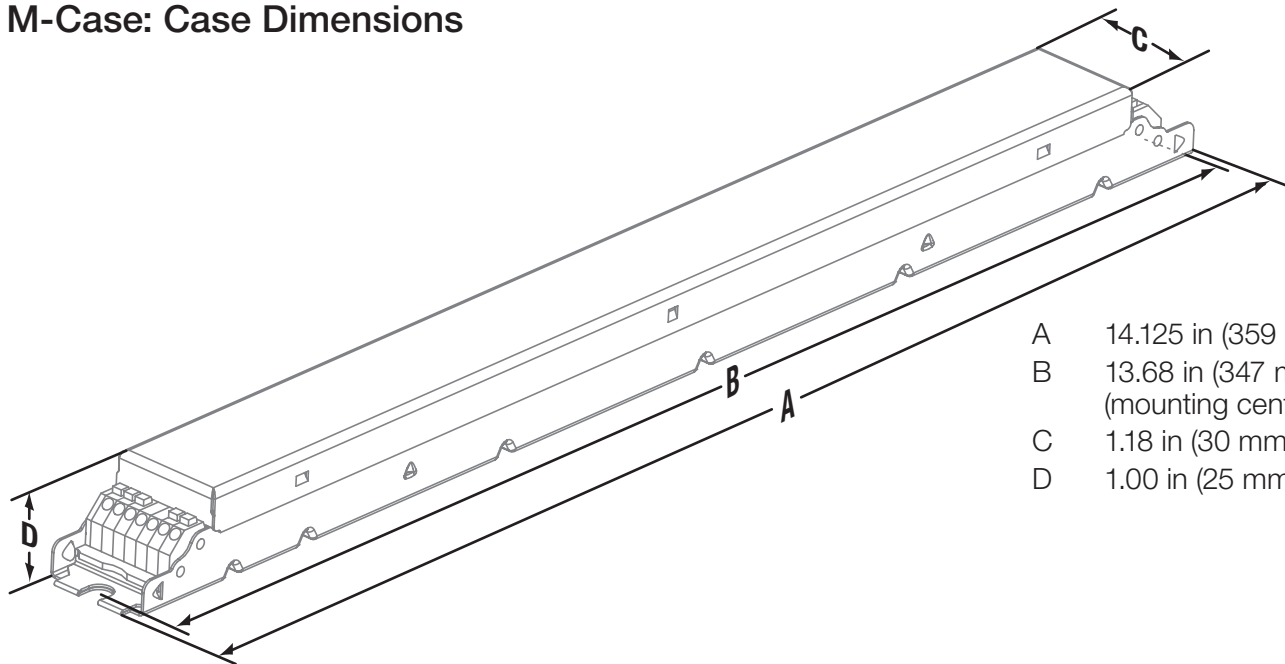

- A 14.125 in (359 mm)
- B 13.68 in (347 mm)
(mounting center)
- C 1.18 in (30 mm)
- D 1.00 in (25 mm)

Job Name:	Model Numbers:
Job Number:	

KL Case: Case Dimensions

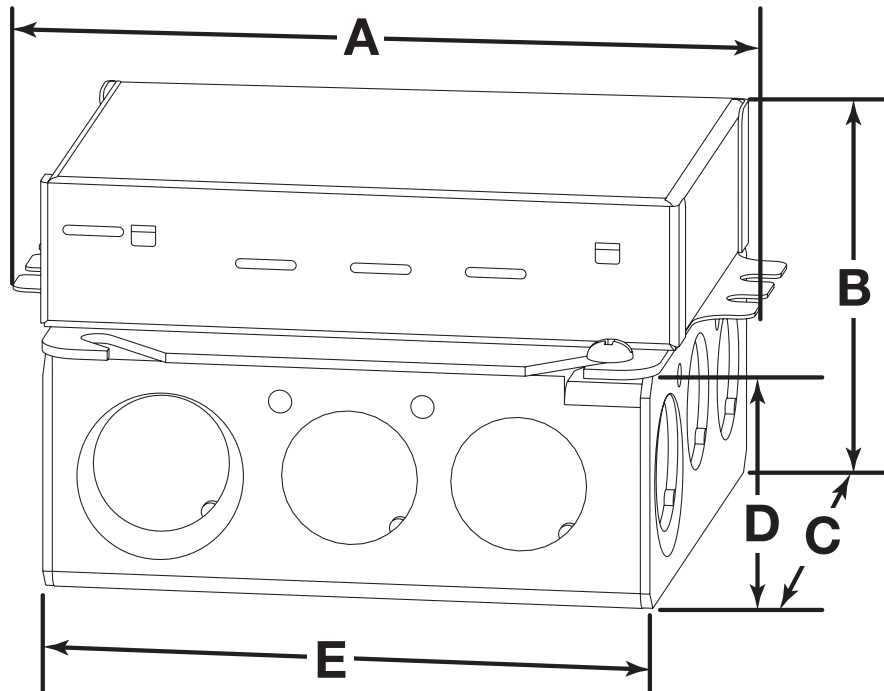

A	4.89 in (124 mm)
B	2.62 in (66 mm)
C	4.00 in (102 mm)
D	1.62 in (41 mm)
E	4.00 in (102 mm)

KL case includes a 4 in (102 mm) square junction box which complies with NEMA OS 1-2008 Figure 112.

Knockouts

- Sides
 - 8 locations: 0.5 in (13 mm)
 - 4 locations: 0.5/0.75 in (13/19 mm)
- Bottom
 - 2 locations: 0.5 in (13 mm)
 - 2 locations: 0.5/0.75 in (13/19 mm)

Driver Wiring and Mounting

- Driver is grounded by the green ground wire connection on the enclosure or by the ground lug terminal in the junction box
- Driver and junction box must be grounded in accordance with local and national electrical codes
- All wire connections must be made in the junction box to maintain UL listing
- 4 in (102 mm) square junction box is 1.5 in (38 mm) deep with 22.0 in³ (360.5 cm³) capacity and complies with NEMA OS 1-2008 Figure 112
- Driver is pre-wired with 6 in (152 mm), 18 AWG (0.75 mm²) solid copper leads in all terminal blocks

Job Name:	Model Numbers:
Job Number:	

Wiring Diagram for 3-Wire Control

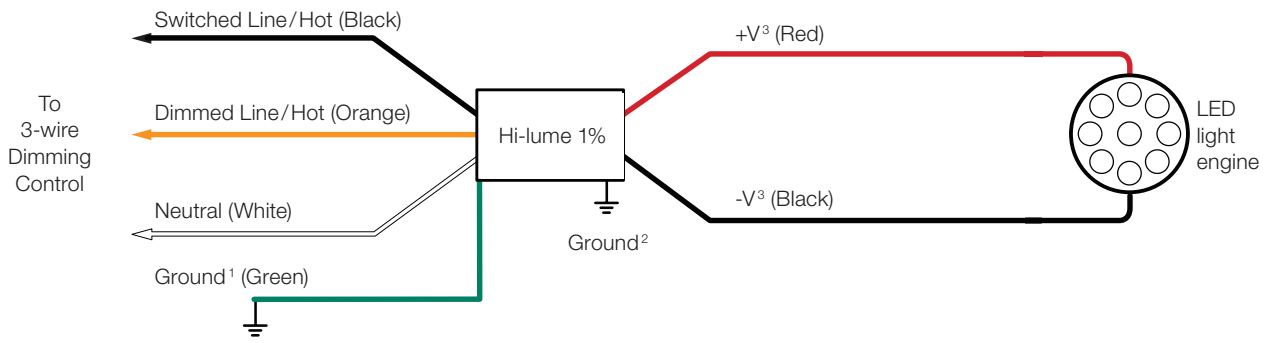

Wiring Diagram for EcoSystem Digital Control

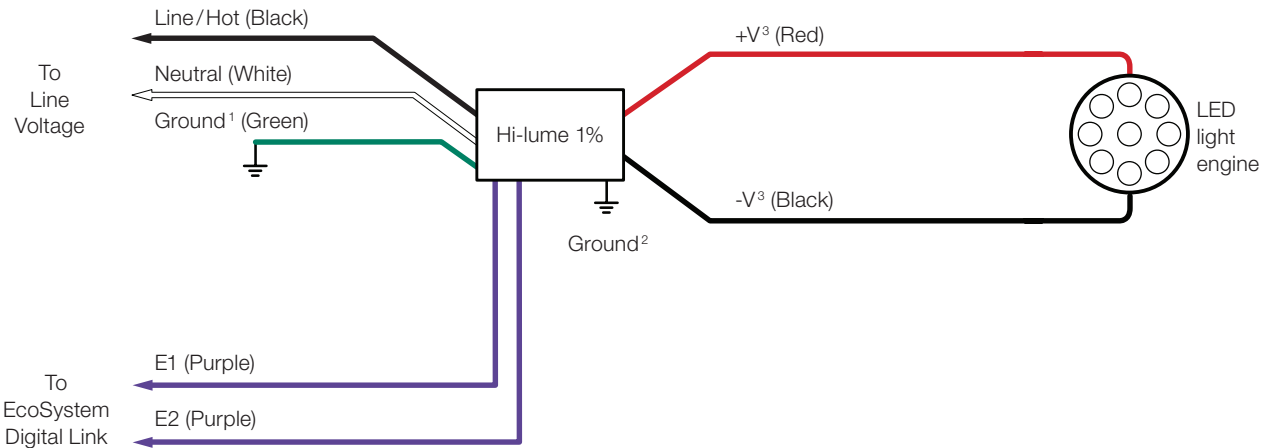

Note: Colors shown correspond to terminal blocks on driver.

- ¹ Ground wire connection available on K-case models only.
- ² Fixture and driver case must be grounded in accordance with local and national electrical codes.
- ³ For maximum driver-to-LED light engine wire length, see charts in **Driver Leads** section at the end of the document.

Job Name:	Model Numbers:
Job Number:	

Compatible Controls

- Guaranteed performance specifications with the controls listed in the chart below.
- For assistance selecting controls, contact our LED Center of Excellence at 1.877.346.5338 or LEDs@lutron.com

Product	Part Number		Drivers per Control				Measured Light Output Range
			40 W Driver		50 W Driver		
	120 V~	277 V~	120 V~	277 V~	120 V~	277 V~	
3-wire Controls: Requires 3rd wire for control signal, see 3-wire diagram on previous page							
Nova T☆	NTF-10-	NTF-10-277-	1-41	1-44	1-31	1-36	100%-1%
	NTF-103P-	NTF-103P-277-	1-20	1-33	1-15	1-27	100%-1%
Nova	NF-10-	NF-10-277-	1-41	1-44	1-31	1-36	100%-1%
	NF-103P-	NF-103P-277-	1-20	1-33	1-15	1-27	100%-1%
Skylark	SF-10P-	SF-12P-277-	1-20	1-33	1-15	1-27	100%-1%
	SF-103P-	SF-12P-277-3	1-20	1-33	1-15	1-27	100%-1%
Diva	DVF-103P-	DVF-103P-277-	1-20	1-33	1-15	1-27	100%-1%
	DVSCF-103P-	DVSCF-103P-277-	1-20	1-33	1-15	1-27	100%-1%
Ariadni	AYF-103P-	AYF-103P-277-	1-20	1-44	1-15	1-27	100%-1%
Maestro	MAF-6AM-	MAF-6AM-277-	1-15	1-20	1-11	1-20	100%-1%
	MSCF-6AM-	MSCF-6AM-277-	1-15	1-20	1-11	1-20	100%-1%
Maestro Wireless	MRF2-F6AN-DV-		1-15	1-33	1-11	1-27	100%-1%
RadioRA 2	RRD-F6AN-DV-		1-15	1-33	1-11	1-27	100%-1%
HomeWorks QS	HQRD-F6AN-DV		1-15	1-33	1-11	1-27	100%-1%
Interfaces ¹	PHPM-3F-120	-	1-41	-	1-31	-	100%-1%
	PHPM-3F-DV		1-41	1-88	1-31	1-72	100%-1%
GP Dimming Panels	Various		1-41	1-88	1-31	1-72	100%-1%
EcoSystem Controls: See EcoSystem Controls wiring diagram on previous page							
PowPak dimming module with EcoSystem	RMJ-ECO32-DV-B		32 per EcoSystem link				100%-1%
	FCJ-ECO, FCJS-ECO		3 per EcoSystem link ²				100%-1%
Energi Savr Node with EcoSystem	QSN-1ECO-S, QSN-2ECO-S		64 per EcoSystem link				100%-1%
GRAFIK Eye QS with EcoSystem	QSGRJ-_E, QSGR-_E	-	64 per EcoSystem link				100%-1%
Quantum	Various		64 per EcoSystem link				100%-1%

¹ For use with 3-wire controls or Commercial Systems, RadioRA 2 Systems or Home Systems applications.

² Up to 3 drivers controlled as a single zone (broadcast EcoSystem).

Job Name:	Model Numbers:
Job Number:	

EcoSystem Wiring Diagrams

EcoSystem Digital Link Overview

- The EcoSystem Digital Link wiring (E1 and E2) connects the digital ballasts and drivers together to form a lighting control system.
- Each EcoSystem Digital Link supports up to 64 digital ballasts, LED drivers or EcoSystem Modules (e.g. C5-BMJ-16A, C5-XPJ-16A), 32 occupancy sensors (64 occupancy sensors with Energi Savr Node with EcoSystem), 16 daylight sensors, and 64 wallstations or IR receivers.*
- Sensors do not directly connect to Hi-lume 1% EcoSystem/3-Wire LED drivers.
- E1 and E2 (EcoSystem digital link wires) are polarity insensitive and can be wired in any topology.
- An Energi Savr Node unit with EcoSystem, GRAFIK Eye QS control unit with EcoSystem, PowPak dimming module with EcoSystem, or Quantum system provides power for the EcoSystem Digital Link and supports system programming.*
- All EcoSystem Digital Link programming is completed by using the Energi Savr app for Apple iPad, iPod Touch or iPhone mobile digital devices, GRAFIK Eye QS with EcoSystem, PowPak dimming module with EcoSystem, or Quantum system.

EcoSystem Digital Link Wiring

- Driver EcoSystem Digital Link terminals only accept one 18 AWG to 16 AWG (0.75 mm² to 1.5 mm²) solid copper wire per terminal.
- Make sure that the supply breaker to the Digital Driver and EcoSystem Digital Link Supply is OFF when wiring.
- Connect the two conductors to the two Digital Driver terminals E1 and E2 as shown.
- Using two different colors for E1 and E2 will reduce confusion when wiring several drivers together.
- The EcoSystem Digital Link may be wired Class 1 or Class 2. Consult applicable electrical codes for proper wiring practices.

* PowPak dimming module with EcoSystem provides power for the EcoSystem Digital Link and can support 32 digital ballasts, LED drivers or EcoSystem Modules, 6 Wireless Occupancy Sensors, 1 Wireless Daylight Sensor, and 9 Pico Wireless Controllers.

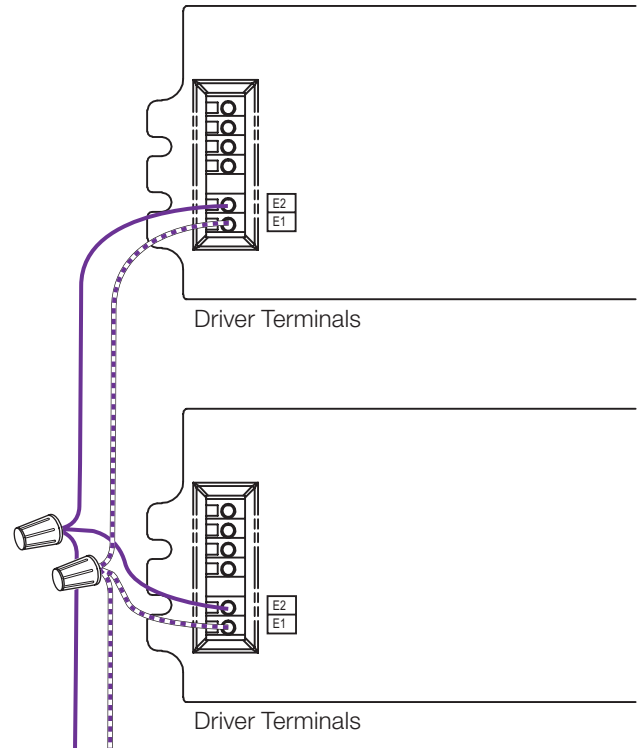

To the EcoSystem Digital Bus and additional drivers and/or ballasts

Notes

- The EcoSystem Digital Link Supply does not have to be located at the end of the Digital Link.
- EcoSystem Digital Link length is limited by the wire gauge used for E1 and E2 as follows:

Wire Gauge	Digital Link Length (max)
12 AWG	2200 ft
14 AWG	1400 ft
16 AWG	900 ft
18 AWG	550 ft

Wire Size	Digital Link Length (max)
4.0 mm ²	828 m
2.5 mm ²	517 m
1.5 mm ²	310 m
1.0 mm ²	207 m
0.75 mm ²	155 m

Job Name:	Model Numbers:
Job Number:	

Electricians and Contractors

Driver Leads

Maximum driver-to-LED light engine wire length for
Constant-Current Drivers:

Wire Gauge*	Maximum Lead Length		
	200 mA to 700 mA	710 mA to 1.50 A	1.51 A to 2.10 A
24 AWG (0.2 mm ²)	8 ft (2.5 m)	4 ft (1.2 m)	2.75 ft (0.8 m)
22 AWG (0.34 mm ²)	13 ft (4 m)	6 ft (1.8 m)	4.5 ft (1.5 m)
20 AWG (0.5 mm ²)	20 ft (6 m)	10 ft (3 m)	7 ft (2 m)
18 AWG (0.75 mm ²)	30 ft (9 m)	15 ft (4.5 m)	10 ft (3 m)
16 AWG (1.5 mm ²)	35 ft (10.5 m)	25 ft (7.5 m)	15 ft (4.5 m)
14 AWG (2.5 mm ²)	50 ft (15 m)	40 ft (12 m)	25 ft (7.5 m)
12 AWG (4.0 mm ²)	100 ft (30 m)	60 ft (18 m)	40 ft (12 m)

Maximum driver-to-LED light engine wire length for
Constant-Voltage Drivers:

Wire Gauge*	Maximum Lead Length		
	10 V to 20 V	20.5 V to 40 V	40.5 V to 60 V
24 AWG (0.2 mm ²)	2.5 ft (0.8 m)	4 ft (1.2 m)	8 ft (2.5 m)
22 AWG (0.34 mm ²)	4 ft (1.2 m)	6 ft (1.8 m)	12 ft (3.7 m)
20 AWG (0.5 mm ²)	6 ft (1.8 m)	10 ft (3 m)	20 ft (6 m)
18 AWG (0.75 mm ²)	10 ft (3 m)	15 ft (4.5 m)	30 ft (9 m)
16 AWG (1.5 mm ²)	15 ft (4.5 m)	25 ft (7.5 m)	50 ft (15 m)
14 AWG (2.5 mm ²)	25 ft (7.5 m)	40 ft (12 m)	75 ft (22.5 m)
12 AWG (4.0 mm ²)	40 ft (12 m)	60 ft (18 m)	100 ft (30 m)

* Terminal blocks on the drivers accept only solid 18 or 16 AWG (0.75 or 1.5 mm²) wire. To use wire gauges larger or smaller than this terminal blocks' rated gauge of 18 or 16 AWG (0.75 or 1.5 mm²) refer to the **Terminal Wiring Gauges** diagram at the end of this document. Connect up to 3 ft (0.9 m) of 18 or 16 AWG (0.75 or 1.5 mm²) wire to the LED driver terminal blocks, then connect 14 to 12 AWG (2.5 to 4.0 mm²) or 24 AWG to 20 AWG (0.20 mm² to 0.50 mm²) up to the length allowed in the above table.

Wiring and Grounding

Driver and lighting fixture must be grounded. Drivers must be installed per national and local electrical codes.

LED Load Replacement

For Class 2 rated drivers, the LED load can be changed while the driver is installed and powered.

Maximum Driver Operating Temperature

Driver case temperature (t_c) must not exceed:

- 149 °F (65 °C) for 40 W drivers.
- 158 °F (70 °C) for 50 W drivers.

FOR CASE TYPE KL, REMOTE-MOUNTABLE MODELS:

This device complies with part 15 of the FCC Rules. Operation is subject to the following two conditions: (1) This device may not cause interference and (2) This device must accept any interference, including interference that may cause undesired operation.

NOTE: This equipment has been tested and found to comply with the limits for a Class A digital device, pursuant to part 15 of the FCC Rules. These limits are designed to provide reasonable protection against harmful interference in a residential installation. This equipment generates, uses and can radiate radio frequency energy and, if not installed and used in accordance with the instructions, may cause harmful interference to radio communications. However, there is no guarantee that interference will not occur in a particular installation. If this equipment does cause harmful interference to radio or television reception, which can be determined by turning the equipment off and on, the user is encouraged to try to correct the interference by one or more of the following measures:

- Reorient or relocate the receiving antenna.
- Increase the separation between the equipment and receiver.
- Connect the equipment into an outlet on a circuit different from that to which the receiver is connected.
- Consult the dealer or an experienced radio/TV technician for help.

Facilities Managers

SERVICE

Warranty

For warranty information, please visit www.lutron.com/driverwarranty

Replacement Parts

When ordering Lutron replacement parts please provide the full model number. Consult Lutron Technical Support if you have any questions.

Further Information

For further information, please visit us at www.lutron.com/hilume1led or contact our LED Control Center of Excellence at 1.877.346.5338 or LEDs@lutron.com

Job Name:	Model Numbers:
Job Number:	

Terminal Wiring Gauges

Wire colors shown correspond to terminal blocks on driver.

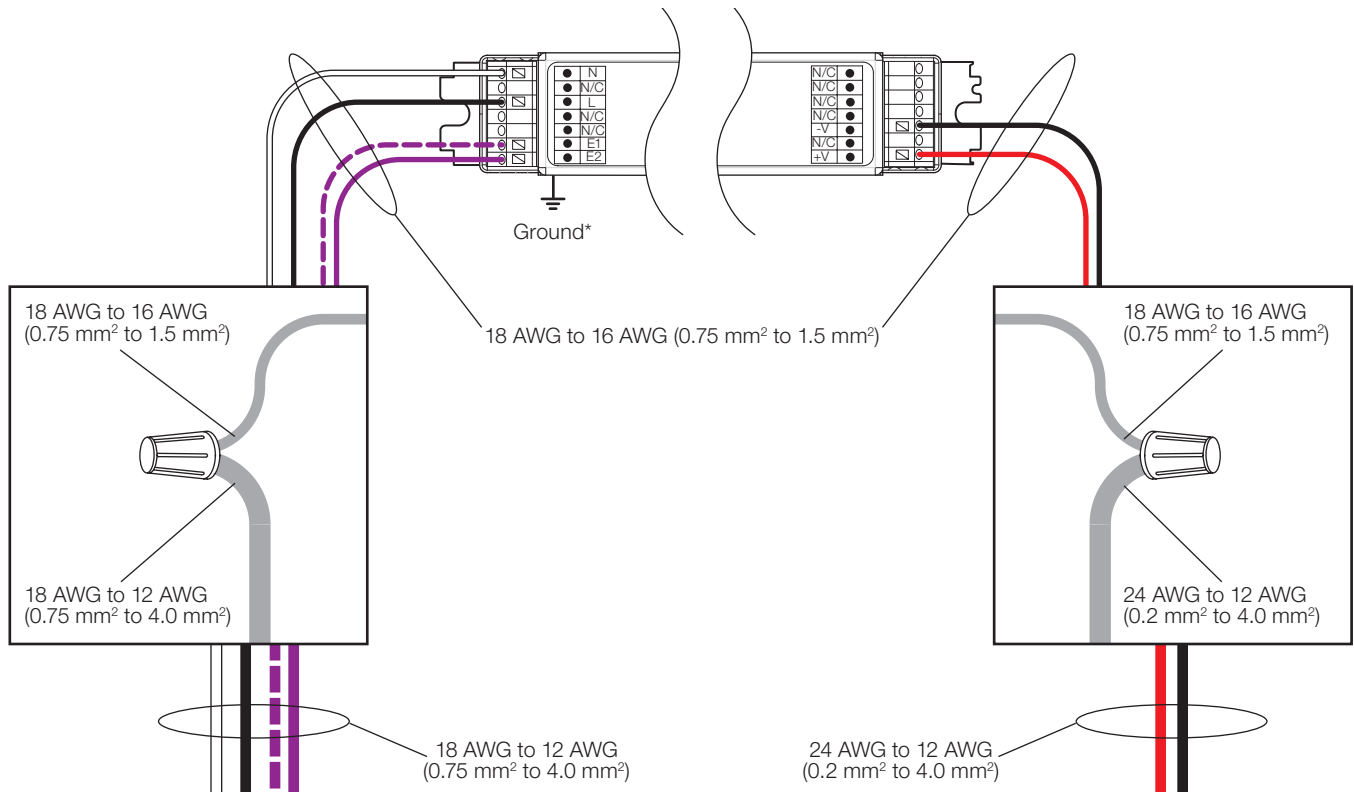

* Fixture and driver case must be grounded in accordance with local and national electrical codes. Ground connection to driver case can be accomplished through ground terminal, and/or grounding the case. Ground connection to M case driver (shown) requires connection to stud in fixture.

Lutron, the Lutron logo, Hi-lume, EcoSystem, GRAFIK Eye, PowPak, Quantum, Nova T*, Nova, Skylark, Diva, Ariadni, Maestro, Maestro Wireless, RadioRA, HomeWorks, Energi Savr Node, QwikFig, and RadioRA 2 are trademarks or registered trademarks of Lutron Electronics Co., Inc. in the US and/or other countries.

Apple, iPad, iPod Touch, and iPhone are trademarks of Apple Inc., registered in the U.S. and other countries.

All other product names, logos, and brands are property of their respective owners.

LUTRON SPECIFICATION SUBMITTAL

Job Name:	Model Numbers:
Job Number:	