

Hi-lume Premier 0.1% EcoSystem/3-wire Constant Voltage 24 V $\overline{=}$ LED Driver with Soft-on, Fade-to-Black

The Hi-lume Premier 0.1% Constant Voltage Driver (L3D0) is a high-performance LED driver capable of controlling up to 96 W of 24 V $\overline{=}$ constant voltage loads. This driver provides smooth and continuous dimming down to 0.1% low-end. It is ideal for use with strip lighting in applications such as coves, under or over cabinet lighting and pathway lighting. The driver is UL \circledR Listed with an integrated wiring compartment and can be mounted up to 150 ft (45 m) away from the load.

Features

- Continuous, flicker-free dimming from 100% to 0.1%¹.
 - Soft-on, Fade-to-Black operation for EcoSystem controls: fades smoothly between 0% and 0.1% when turned on and off for an incandescent like experience.²
 - UL \circledR Listed for United States and Canada (cULus \circledR).
 - NOM certified for Mexico.
 - Field Adjustment Knob offers customer low-end light output tuning for better fixture-to-fixture matching.
 - Guaranteed dimming performance when used with Lutron controls:
 - HomeWorks QS, Energi Savr Node units with EcoSystem controls, GRAFIK Eye QS with EcoSystem controls, PowPak with EcoSystem dimming modules, PowPak with EcoSystem wireless fixture controls, and Quantum systems, allowing for integration into a planned or existing EcoSystem lighting control solution.
 - Lutron 3-wire controls and interfaces.
 - Protected from miswires of input power, up to 277 V \sim , to EcoSystem control inputs.
 - Rated lifetime of 50,000 hours at 40 °C (104 °F) ambient temperature and maximum loading.
 - FCC Part 15
 - Class A (277 V \sim)
 - Class B (120 V \sim)
 - Inrush limiting allows full loading of circuit breakers without nuisance tripping.
- 100% end-of-line performance tested at a Lutron factory.
 - RoHS compliant.
 - Restores all settings after power failure.
 - Barrier provided for Class 2 separation in the wiring compartment.
 - Redundant connections on line and control terminals for easy daisy chain wiring.
 - Redundant connections on output terminals allow for easy wiring of two LED load home runs.
 - Class 2 output designed to withstand hot swap.
 - For more information please visit: www.lutron.com/hilume1softbled
 - Upon loss of Digital EcoSystem control link, drivers go to emergency level (default is high-end, but may be able to be programmed depending on system, for more details see Application Note #106 (P/N 048106) at www.lutron.com

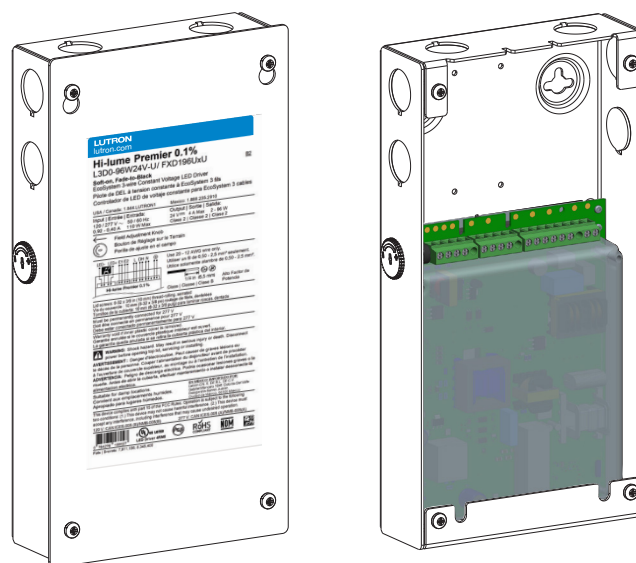

Hi-lume Premier 0.1% Constant Voltage Driver (L3D0)
5.5 in (140 mm) W x 2.0 in (51 mm) H x 10.5 in (267 mm) L

¹ Light output at 0.1% depends on installation and light engine efficacy.

² Soft-on, Fade-to-Black dimming technology is not available for 3-wire controls.

LUTRON SPECIFICATION SUBMITTAL

Page

Job Name:	Model Numbers:
Job Number:	

Specifications

Regulatory Approvals and Compliance

- Lutron Quality Systems registered to ISO 9001.2015
- Manufacturing facilities employ ESD reduction practices that comply with the requirements of ANSI/ESD S20.20
- Meets ANSI C62.41 category A surge protection standards up to and including 4 kV
- FCC Part 15
 - Class A (277 V~)
 - Class B (120 V~)
- CAN ICES-005(A) (277 V~)
- CAN ICES-005(B) (120 V~)
- LED drivers need to meet certain performance criteria in order for the completed luminaires to comply with the ENERGY STAR® Luminaires V2.0 Specification. All models meet these performance criteria throughout their entire load compatibility regions. Consult Application Note #599 (P/N 048599) “ENERGY STAR® Luminaires V2.0 and Lutron Drivers” for availability dates of compliant products.
- LED drivers need to meet certain performance criteria in order for the completed luminaires to comply with Title 24 requirements as detailed in CEC-400-2015-037-CMF. All models meet both commercial (at 120 V~/277 V~) and residential (at 120 V~) performance criteria throughout their entire load operating regions. Consult CEC-400-2015-032-CMF Section 6.2.7 for important information on meeting start-up time requirements with fade-in lighting.
- Meets UL® 8750/CSA C22.2 No. 250.13-14, “Light Emitting Diode (LED) Equipment For Use in Lighting Products”
- NOM certified
- Class 2 output; meets UL® 1310/CSA C22.2 No. 223-M91

Performance

- Dimming Range: 100% to 0.1%¹
- LED lighting turns on to any dimmed level without flashing to full brightness
- Operating Voltage: 120 V~/277 V~ at 50/60 Hz
- Rated lifetime of 50,000 hours at 40 °C (104 °F) ambient temperature and maximum loading
- For rated warranty, ambient temperature (t_a) not to exceed 40 °C (104 °F) (maximum rated temperature)^{2,3}
- Patented thermal fold back protection
- Non-volatile memory restores all driver settings after power failure
- Typical standby power consumption: 0.25 W at 120 V~ and 0.4 W at 277 V~
- Open-circuit protected output
- Short-circuit and overload-protected output
- Output: 24 V= constant voltage at high-end
- Output Load Range: 2 W to 96 W at high-end
- Power Factor: > 0.90 at maximum power
- Total Harmonic Distortion (THD): < 20% at maximum power
- NEMA 410 – 2011 compliant
- Inrush Current Limiting Circuitry: decreases circuit breaker tripping, switch arcing and relay failure; allows full loading of switch leg
- Inrush Current: < 2 A
- Device turn-on time: < 100 ms from electronic off and, < 500 ms from power off
- L3D0-96W24V-U driver is programmed by Lutron manufacturing and is NOT configurable by the Lutron QwikFig configuration system
- NOM Thermal Classification: Class B

¹ Light output at 0.1% depends on installation and light engine efficacy.

² To maintain warranty, installer is responsible for ensuring that the driver ambient temperature does not exceed 40 °C (104 °F).

³ Where t_a is the temperature of the air directly surrounding the driver.

Job Name:	Model Numbers:
Job Number:	

Specifications *(continued)*

Environmental

- Sound rated: Class A inaudible in 24 dBA ambient
- Relative Humidity: maximum 90% non-condensing
- Minimum Operating Ambient Temperature: $t_a = 0\text{ }^\circ\text{C}$ (32 $^\circ\text{F}$)¹
- Indoor use only
- Rated for dry and damp locations
- Meets NEC® requirements for installation in “other space used for environmental air”²
- Meets the Canadian National Building Code Plenum Requirements for a concealed space used as a plenum within a floor or roof assembly
- Maximum heat output of module: 46 BTU/hour

Driver Wiring and Mounting

For best installation practices, please refer to Application Note #591 (P/N 048591) at www.lutron.com.

- Mount the driver in a position where it can be easily located and accessed if service or troubleshooting is necessary.
- Driver is grounded by terminal connection
- Terminal blocks on the driver accept solid or stranded wire per terminal from 20 AWG to 12 AWG (0.50 mm² to 2.5 mm²).
- Maximum wire length between the LED driver and the start of the linear strip for different wire sizes is listed below. The table below can be used independently of the line voltage that is powering the LED Driver.
- Must be permanently connected fixed wiring for 277 V~ application.

Wire Gauge	Maximum Lead Length
24 AWG (0.20 mm ²) ³	6 ft (1.8 m)
22 AWG (0.34 mm ²) ³	10 ft (3.0 m)
20 AWG (0.50 mm ²)	15 ft (4.5 m)
18 AWG (0.75 mm ²)	25 ft (7.62 m)
16 AWG (1.0 mm ²)	40 ft (12.2 m)
14 AWG (1.5 mm ²)	60 ft (18.3 m)
12 AWG (2.5 mm ²)	100 ft (30.5 m)
10 AWG (4.0 mm ²) ³	150 ft (45.7 m)

¹ Where t_a is the temperature of the air directly surrounding the driver.

² Additional considerations may be required based on state and local codes and standards.

³ To use wire gauge larger or smaller than terminal blocks' rated gauge of 20 AWG to 12 AWG (0.50 mm² to 2.5 mm²), connect 1 ft (0.3 m) or less of rated wire from terminal and connect with larger or smaller wire.

Terminal Block Details

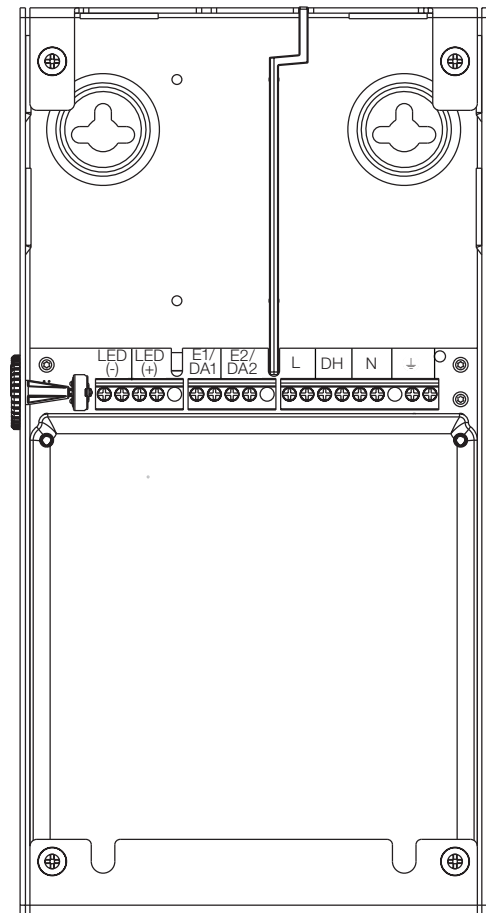

Job Name:

Model Numbers:

Job Number:

Models Available

		Model	Input Voltage (V~)	Input Current ¹ (A)	Typical Power Factor ¹	Typical THD ¹ (%)	Output Power (W)	Output Voltage ¹ (V=)
3-Wire or EcoSystem Control ²	For 24 V= Constant Voltage LED Loads	L3D0-96W24V-U	120	0.92	0.99	8	2-96	24
			277	0.40	0.94	13	2-96	24

¹ At maximum output power.

² For wiring options, see *Wiring* section, pages 9-11.

Efficiency vs. Output Power

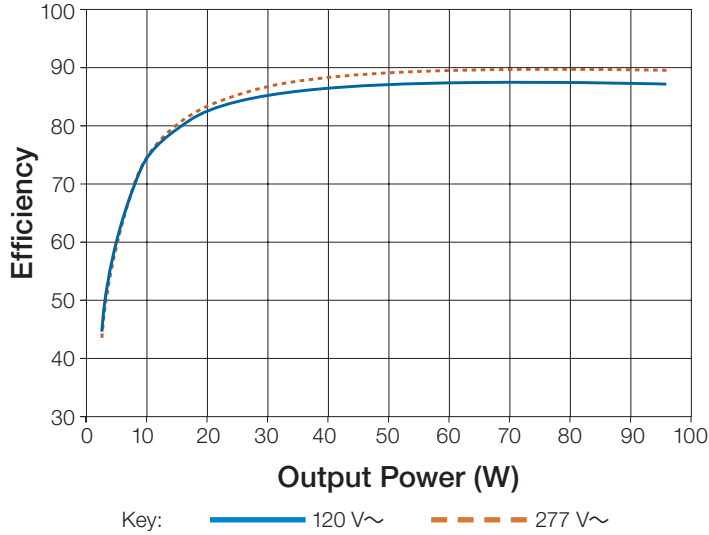

THD vs. Output Power

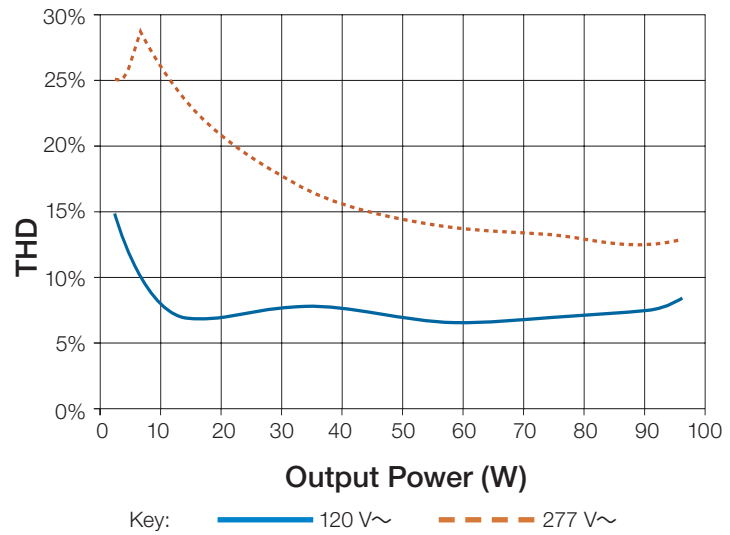

Power Factor vs. Output Power

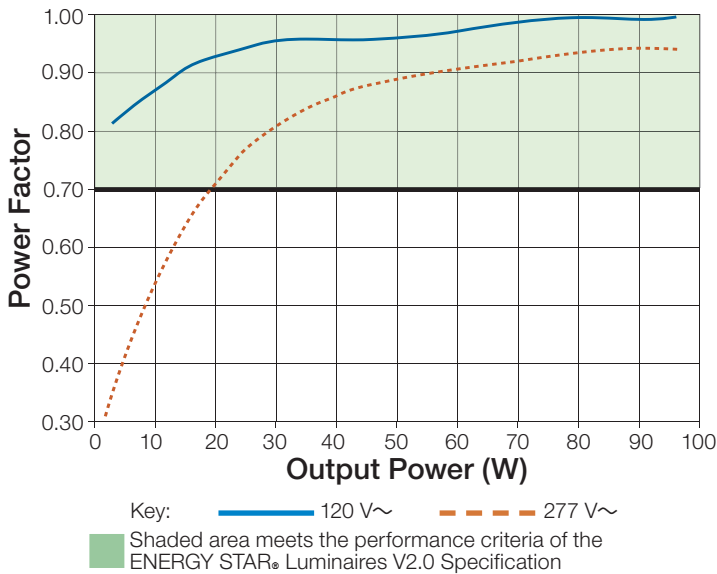

Output Voltage vs. Output Power

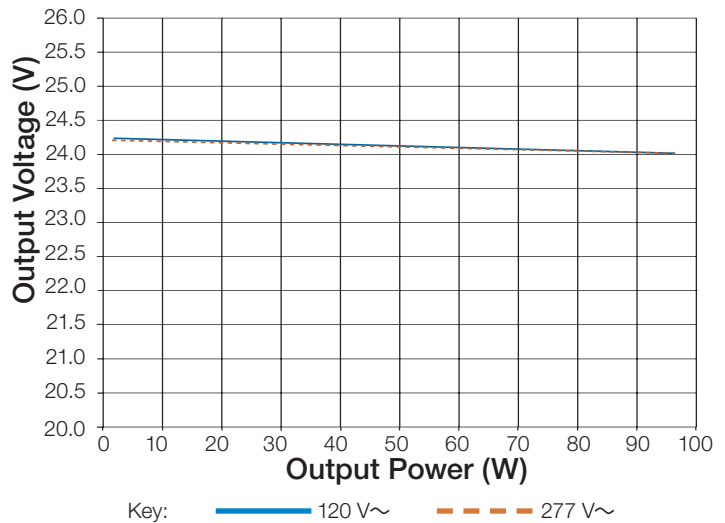

NOTE: Specifications are subject to change without notice.

Job Name:	Model Numbers:
Job Number:	

Enclosure Dimensions

Measurements are shown as: in (mm)

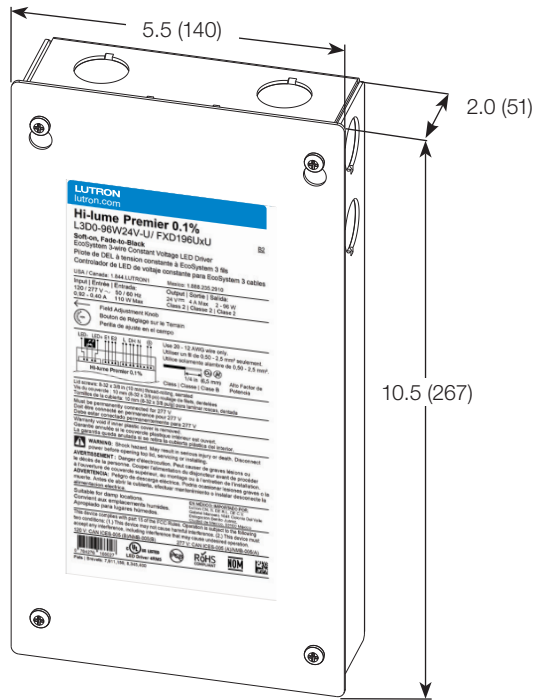

Knockouts

- Sides
 - 4 locations: 1/2 in or 21 mm trade size
- Top
 - 2 locations: 1/2 in or 21 mm trade size

Job Name:	Model Numbers:
Job Number:	

Mounting Options 1,2

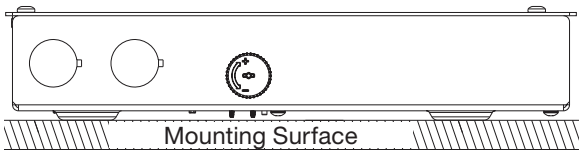
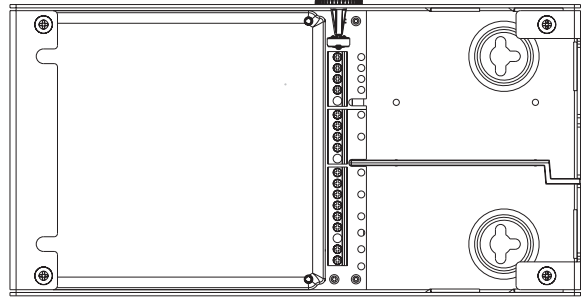
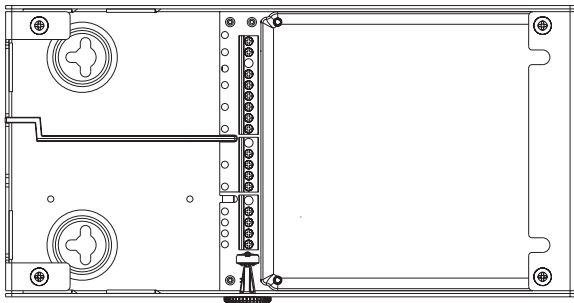
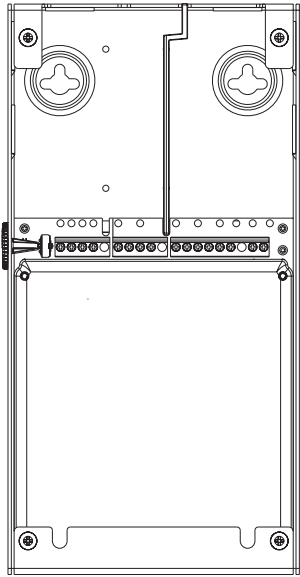

- 1 Any other mounting configuration will require additional mechanical support. Improper installation may result in hazards to personnel or property.
- 2 Mount the driver in a position where it can be easily located and accessed if service or troubleshooting is necessary.

Job Name:	Model Numbers:
Job Number:	

Barrier Installation and Driver Spacing Requirements

Measurements are shown as: in (mm)

Option 1

Option 2

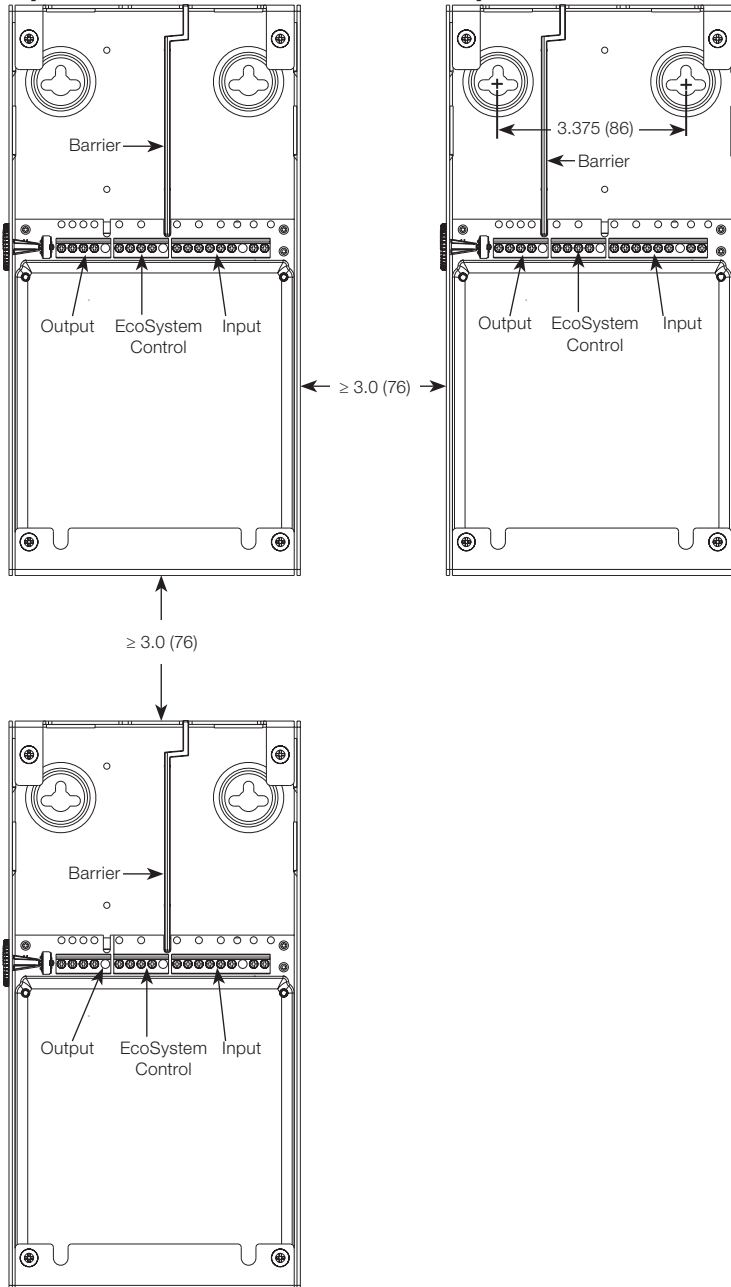

- Optional barrier can be placed either between the input and EcoSystem control terminals (**Option 1**) when the EcoSystem links are wired as Class 2 or between the EcoSystem control and output terminals (**Option 2**) when the EcoSystem links are wired as Class 1.
- For 3-wire control, barrier could be placed in either location.
- The EcoSystem digital link may be wired as Class 1 or Class 2. Please refer to Application Note #162 (P/N 048162) at www.lutron.com.
- Maintain a minimum of 3.0 in (76 mm) between any two Hi-lume Premier 0.1% drivers.

Job Name:	Model Numbers:
Job Number:	

Control Mounting Options *(continued)*

A PowPak Wireless Fixture Control can be mounted on the driver using the driver's available knockouts. Additional considerations may be required based on state and local codes and standards.

PowPak Dimming Module
 Model RMJ-ECO32-DV-B
 OR
 PowPak Fixture Control¹
 Model FCJ-ECO, FCJS-ECO

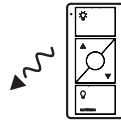

Pico Wireless Control
 Model PJ2-3BRL-GWH-L01

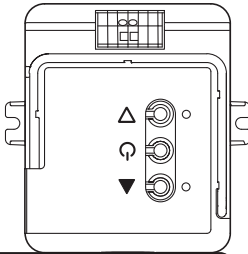

LUTRON
lutron.com

Hi-lume Premier 0.1%
L3D0-96W24V-U/ FXD196UxU B2

Soft-on, Fade-to-Black
EcoSystem 3-wire Constant Voltage LED Driver
Pilote de DEL à tension constante à EcoSystem 3 fils
Controlador de LED de voltaje constante para EcoSystem 3 cables

USA / Canada: 1.844.LUTRON1	Mexico: 1.888.235.2910
Input Entrée Entrada: 120 / 277 V ~, 50 / 60 Hz, 0.92 - 0.40 A, 110 W Max	Output Sortie Salida: 24 V rms, 4 A Max, 2 - 96 W, Class 2 Classe 2 Clase 2

← Field Adjustment Knob
Bouton de Réglage sur le Terrain
Perilla de ajuste en el campo

LED: LED+ E1 E2 L DH N

 Use 20 - 12 AWG wire only.
 Utiliser un fil de 0.50 - 2.5 mm² seulement.
 Utilice solamente alambre de 0.50 - 2.5 mm².

Hi-lume Premier 0.1%
 Class | Classe | Clase B
 1/4 in (6.5 mm) Alto Factor de Potencia

Lid screws: 8-32 x 3/8 in (10 mm) thread-rolling, serrated
 Vis du couvercle: 10 mm (8-32 x 3/8 pou) oulage de filet, dentelées
 Tornillos de la cubierta: 10 mm (8-32 x 3/8 pulg) para laminar rosas, dentada

Must be permanently connected for 277 V
 Doit être connecté en permanence pour 277 V
 Debe estar conectado permanentemente para 277 V

Warranty void if inner plastic cover is removed.
 Garantie annulée si le couvercle plastique intérieur est ouvert.
 La garantía queda anulada si se retira la cubierta plástica del interior.

WARNING: Shock hazard. May result in serious injury or death. Disconnect power before opening top lid, servicing or installing.

AVERTISSEMENT: Danger d'électrocution. Peut causer de graves lésions ou le décès de la personne. Couper l'alimentation du disjoncteur avant de procéder à l'ouverture de couvercle supérieur, au montage ou à l'entretien de l'installation.

ADVERTENCIA: Peligro de descarga eléctrica. Podría ocasionar lesiones graves o la muerte. Antes de abrir la cubierta, efectuar mantenimiento o instalar desconecte la alimentación eléctrica.

Suitable for damp locations.
 Convient aux emplacements humides.
 Apropiado para lugares húmedos.

EN MEXICO, IMPORTADO POR:
 Lutron (C) S. DE RL. DE CV
 Carretera Mexicana 1041 Colonia Del Valle
 Delegación Benito Juárez
 Ciudad de México, 03100 México

This device complies with part 15 of the FCC Rules. Operation is subject to the following two conditions: (1) This device may not cause harmful interference. (2) This device must accept any interference, including interference that may cause undesired operation.

120 V, CAN (ICES-005, @INMS-005(B)) 277 V, CAN (ICES-005 (A)INMS-005(A))

3 784276 186021
 Part | Brochure: 7,911,156, 8,345,400

Hi-lume Premier 0.1% Constant Voltage Driver
 Model L3D0-96W24V-U

¹ The wireless fixture control will need to have its low-end level reprogrammed to dim to 0.1% output. For more detail on adjusting the low-end light level, refer to Application Note #556 at www.lutron.com, call 1.877.346.5338 (U.S.A. and Canada only), or email LEDs@lutron.com

LUTRON	SPECIFICATION SUBMITTAL	Page
Job Name:	Model Numbers:	
Job Number:		

Wiring

L3D Models: 3-Wire Controls (third wire required for control signal) Wiring Diagram

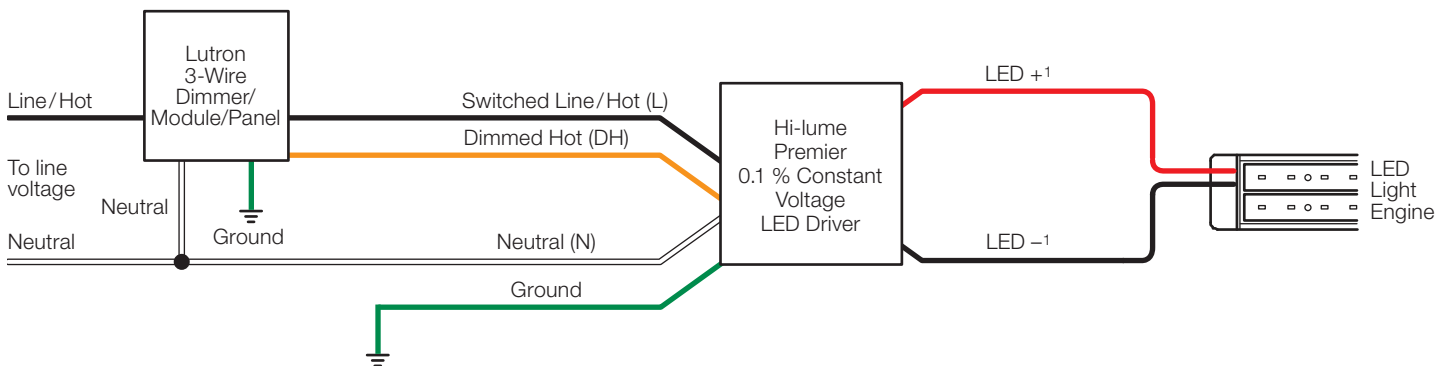

Compatible Controls without Soft-on, Fade-to-Black dimming technology: Lutron 3-Wire Controls⁵
Guaranteed performance specifications with the controls listed in the chart below.

For assistance selecting controls, contact our LED Center of Excellence at **1.877.346.5338** (U.S.A. and Canada only) or **LEDs@lutron.com**

Product	Model Number		Drivers per Control ²		Load Type	Low-end Trim Setting
	120 V~	277 V~	120 V~	277 V~		
Nova T★ dimmer	NTF-10-	NTF-10-277-	1-16	1-19	—	—
	NTF-103P-	NTF-103P-277-	1-8	1-14	—	—
Nova dimmer	NF-10-	NF-10-277-	1-16	1-19	—	—
	NF-103P-	NF-103P-277-	1-8	1-14	—	—
Skylark dimmer	SF-10P-	SF-12P-277-	1-8	1-14	—	—
	SF-103P-	SF-12P-277-3-	1-8	1-14	—	—
Diva dimmer	DVF-103P-	DVF-103P-277-	1-8	1-14	—	—
	DVSCF-103P-	DVSCF-103P-277-	1-8	1-14	—	—
Ariadni dimmer	AYF-103P-	AYF-103P-277-	1-8	1-14	—	—
Maestro dimmer	MAF-6AM-	MAF-6AM-277-	1-6	1-14	—	—
	MSCF-6AM-	MSCF-6AM-277-	1-6	1-14	—	—
Maestro Wireless dimmer	MRF2-F6AN-DV-		1-6	1-14	—	—
RadioRA 2 dimmer	RRD-F6AN-DV-		1-6	1-14	Dual voltage 3-wire dimmer	21% ⁴
HomeWorks QS dimmer	HQRD-F6AN-DV-		1-6	1-14	Fluorescent 3-wire LED 3-wire	21% ⁴
Interfaces ³	PHPM-3F-120-	—	1-16	—	—	—
	PHPM-3F-DV-		1-16	1-38	—	—
	BCI-0-10		1-16	1-38	—	—
GP dimming panels	Various		1-16	1-38	2-1	—

¹ For the maximum wire length between the LED driver and the start of the linear strip, see charts in the **Driver Wiring and Mounting** section.
² No derating required in multi-gang applications provided that the fixture-count does not exceed the quantity listed.
³ Please refer to interface specification sheet for compatible system list.
⁴ Trim level allows the ability to get to 0.1% but might result in dead travel for 1%–4% on user interface for some installations. In this instance, 22% trim level could be used to avoid dead travel but might result in >0.1% dim level.
⁵ Soft-on, Fade-to-Black dimming technology is not available for 3-wire controls.
Note: For information about Legacy product use in existing control applications, contact LEDs@lutron.com

Job Name:	Model Numbers:
Job Number:	

Wiring (continued)

L3D Models: EcoSystem Digital Controls

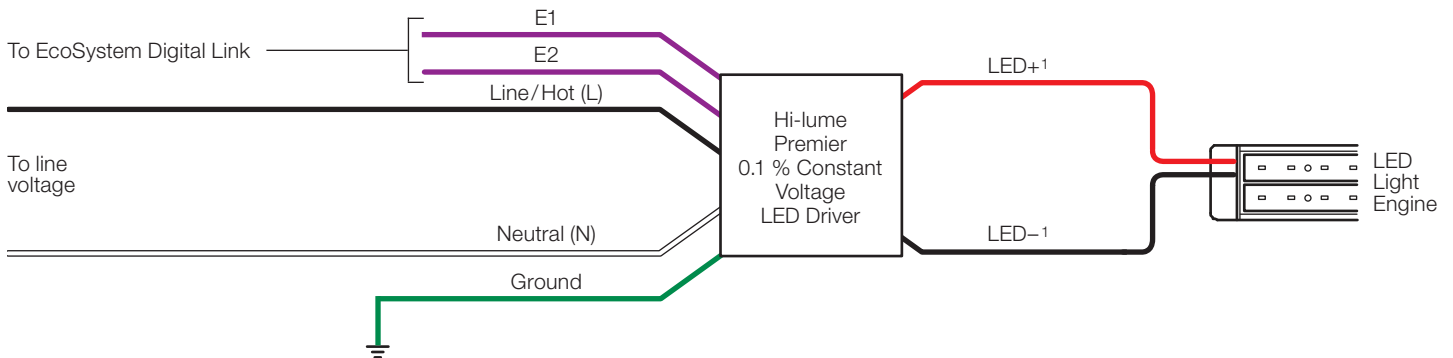

Compatible Controls with Soft-on, Fade-to-Black dimming technology: Lutron EcoSystem Digital Controls

Guaranteed performance specifications with the controls listed in the chart below.

For assistance selecting controls, contact our LED Center of Excellence at **1.877.346.5338** (U.S.A. and Canada only) or **LEDs@lutron.com**

Lutron EcoSystem Compatible Controls	Part Number		Drivers per Control			Minimum Control Version	Minimum System Version ⁴
	120 V~	277 V~	EcoSystem Loops per Control	Drivers per EcoSystem Loop	Maximum Drivers per Control		
PowPak Dimming Modules	RMJ-ECO32-DV-B		1	32	32	5.9 or higher	N/A
	FCJ/FCJS-ECO ^{2,3}		1	3	3	0796554 or higher	N/A
Energi Savr Node	QSN-1ECO-S	N/A	1	64	64	9.027 or higher	N/A
	QSN-2ECO-S		2	64	128		
GRAFIK Eye QS / HomeWorks QS control unit	QSGRJ-_E (wireless) QSGR-_E	N/A	1	64	64	9.009 or higher	N/A
Quantum Hub	QP2-__ 2C	N/A	2	64	128	N/A	3.1 or higher
	QP2-__ 4C		4	64	256		
	QP2-__ 6C		6	64	384		
	QP2-__ 8C		8	64	512		
HomeWorks QS / myRoom Plus power module	LQSE-2ECO-D	N/A	2	64	128	9.027 or higher	7 or higher

- For the maximum wire length between the LED driver and the start of the linear strip, see charts in the **Driver Wiring and Mounting** section.
- All devices connected to one FCJ/FCJS-ECO will be controlled together. Devices will dim to the same level as the result of a control command. The wireless fixture control will need to have its low-end level reprogrammed to dim to 0.1% output. For more detail on adjusting low-end light level refer to Application Note #556 (P/N 048556) at www.lutron.com.
- For the Line/Hot (L/H) terminal on the driver, it is preferred not to use the switched hot (red) wire from the control but rather the hot wire directly from the power source.
- For lower system versions, please visit www.lutron.com/LEDsystemcheck to check if your system requires changes.

LUTRON SPECIFICATION SUBMITTAL		Page
Job Name:	Model Numbers:	
Job Number:		

Wiring (continued)

Continuous LED Light Run

In a continuous LED light run, it is best to connect the load wires in the middle of the LED light run. Please consult load manufacturer best practices for any additional consideration in load installation.

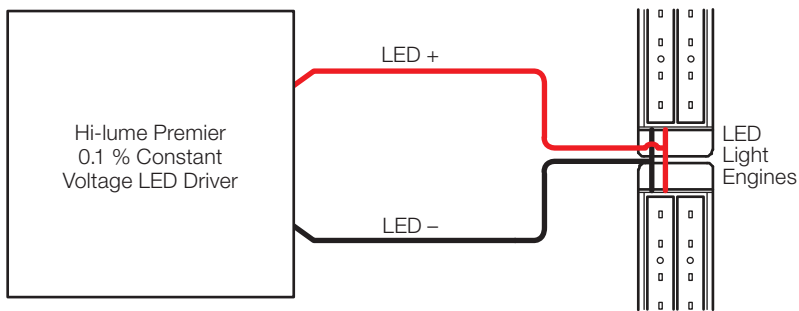

When connecting several LED light homeruns, ensure that the wire lengths and wattages match as closely as possible for best performance.

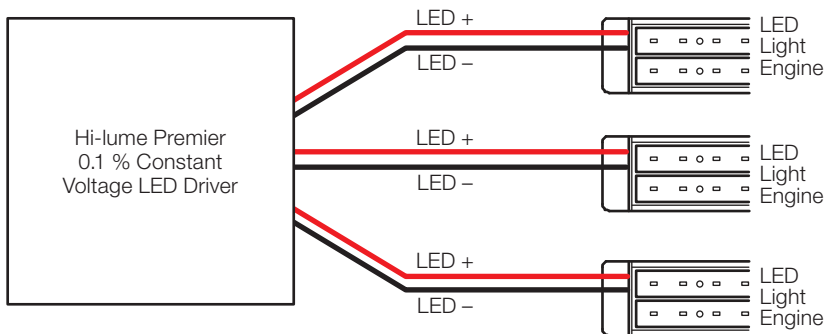

For installation best practices, please refer to Application Note #591 (P/N 048591) at www.lutron.com

Job Name:	Model Numbers:
Job Number:	

EcoSystem Wiring

EcoSystem Digital Link Overview

- The EcoSystem Digital Link wiring (E1 and E2) connects the drivers together to form a lighting control system.
- Sensors do not connect directly to drivers. Sensors are integrated through the EcoSystem controller.
- E1 and E2 (EcoSystem Digital Link wires) are polarity-insensitive and can be wired in any topology.
- Power is supplied to the EcoSystem Digital Link from the control system.
- Protected from miswires of input power, up to 277 V~, to EcoSystem control inputs.

EcoSystem Digital Link Wiring

- EcoSystem Digital Link terminals accept 20 AWG to 12 AWG (0.50 mm² to 2.5 mm²) solid or stranded copper wire per terminal.
- Make sure that the supply breaker to the drivers and EcoSystem Digital Link Supply is OFF when wiring.
- E1 and E2 terminals of the drivers can be daisy chained as shown to the right.
- Using two different colors for E1 and E2 will reduce confusion when wiring several drivers together.
- The EcoSystem Link may be wired Class 1 or Class 2 (See Lutron Application Note #162 (P/N 048162) at www.lutron.com for more details). Consult applicable electrical codes for proper wiring practices. Ensure that the barrier placement is consistent with this wiring choice.
- For emergency wiring, please refer to Lutron Application Note #106 (P/N 048106) at www.lutron.com.

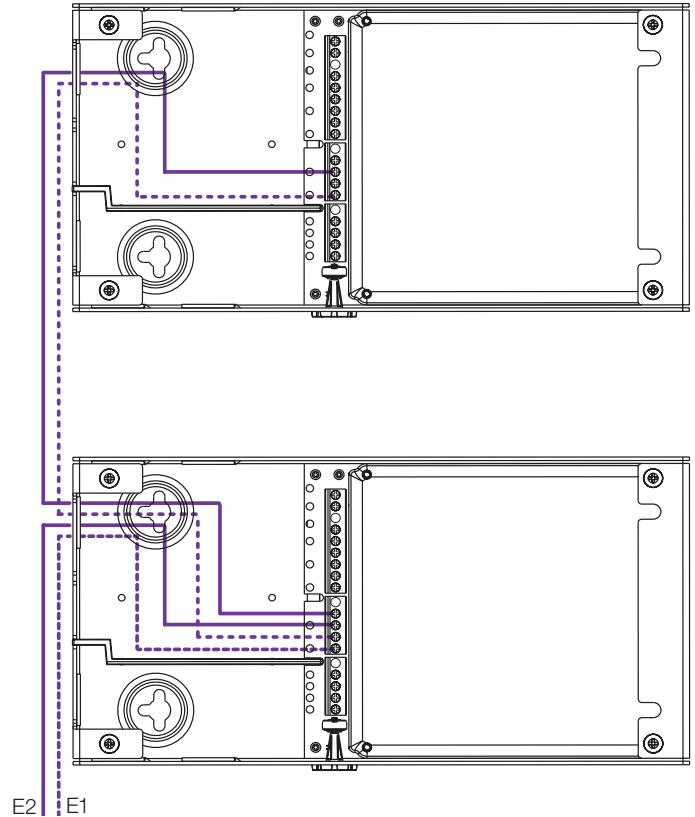

Notes

- The EcoSystem Digital Link Supply does not have to be located at the end of the Digital Link.
- EcoSystem Digital Link length is limited by the wire gauge used for E1 and E2 as follows:

Wire Gauge	Digital Link Length (max)
12 AWG	2200 ft
14 AWG	1400 ft
16 AWG	900 ft
18 AWG	550 ft
20 AWG	352 ft

Wire Size	Digital Link Length (max)
2.5 mm ²	828 m
1.5 mm ²	517 m
1.0 mm ²	310 m
0.75 mm ²	207 m
0.50 mm ²	155 m

Job Name:	Model Numbers:
Job Number:	

Field Adjustment Knob

The Field Adjustment Knob is located on the side of the Hi-lume Premier 0.1% Constant Voltage Driver (L3D0) enclosure. This feature enables the customer to tune the lowest light output achieved during normal operation. An example of this scenario is shown in the image below. Adjusting the Field Adjustment Knob of the lower light output driver minimizes the light output difference and sets the low-end light level at 0.1%. This feature **only needs** to be used in cases of mismatched loads that are separately controlled by 2 or more units.

Figure 1: Cove Lighting with Mismatched Light Output at Low-End Due to Installation Variability

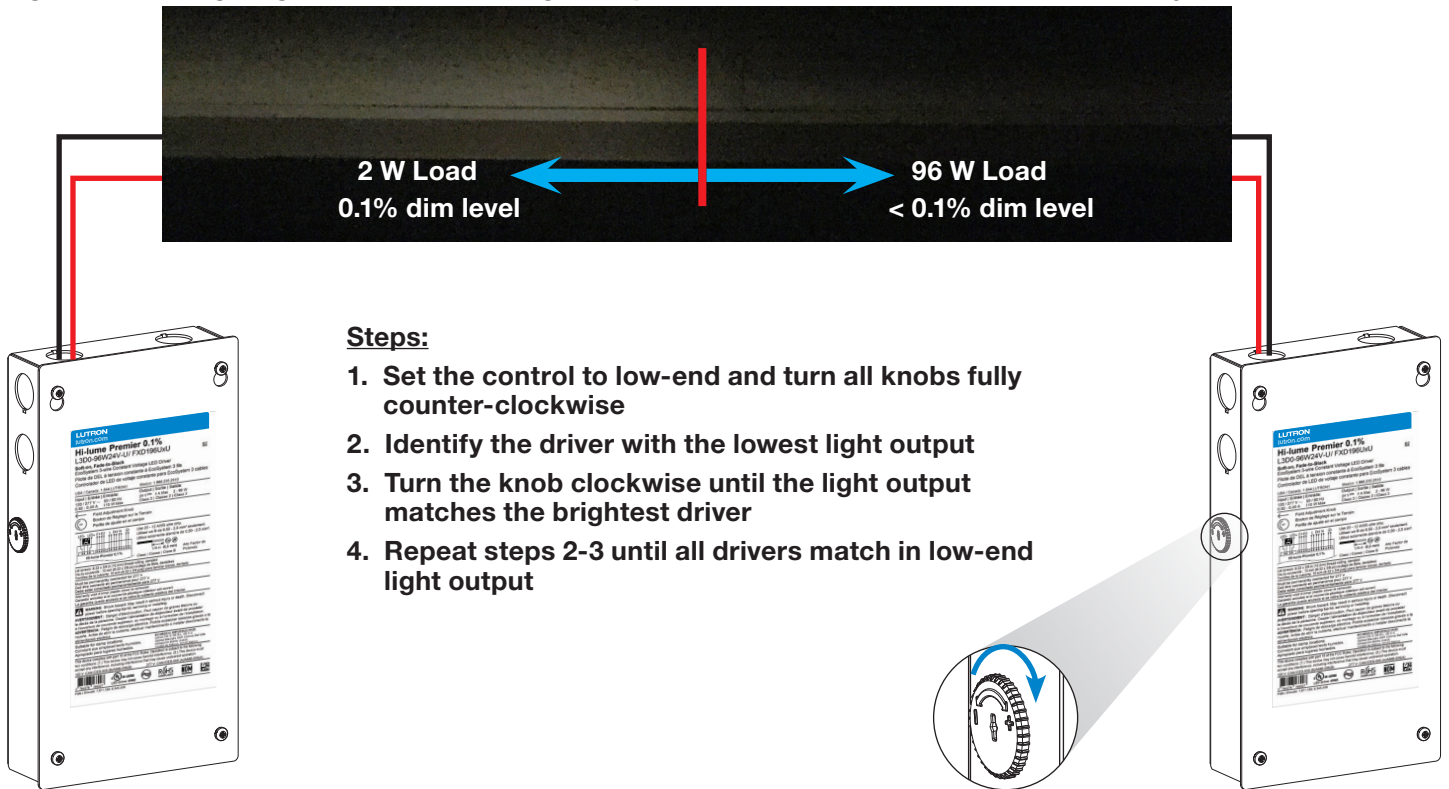
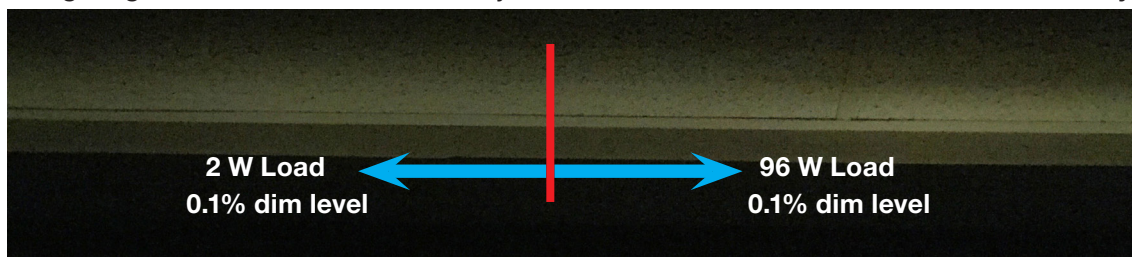

Figure 2: Cove Lighting After the Use of the Field Adjustment Knob Eliminates Mismatch without Costly Re-wiring



The Field Adjustment Knob cannot fix light level mismatch among loads on the same driver. For example, two homeruns of different wattage. For increasing the minimum light output of all the drivers in a space, please use the control's low-end trim feature. Using the Field Adjustment Knob for this purpose will degrade On/Off transition performance.

Job Name:	Model Numbers:
Job Number:	

Facilities Manager

This device complies with part 15 of the FCC Rules. Operation is subject to the following two conditions: (1) This device may not cause harmful interference, and (2) this device must accept any interference received, including interference that may cause undesired operation.

277 V~ NOTE: This equipment has been tested at 277 V~ and found to comply with the limits for a Class A digital device, pursuant to part 15 of the FCC Rules. These limits are designed to provide reasonable protection against harmful interference when the equipment is operated in a commercial environment. This equipment generates, uses, and can radiate radio frequency energy and, if not installed and used in accordance with the instruction manual, may cause harmful interference to radio communications. Operation of this equipment in a residential area is likely to cause harmful interference in which case the user will be required to correct the interference at their own expense.

120 V~ NOTE: This equipment has been tested at 120 V~ and found to comply with the limits for a Class B digital device, pursuant to part 15 of the FCC Rules. These limits are designed to provide reasonable protection against harmful interference in a residential installation. This equipment generates, uses and can radiate radio frequency energy and, if not installed and used in accordance with the instructions, may cause harmful interference to radio communications. However, there is no guarantee that interference will not occur in a particular installation. If this equipment does cause harmful interference to radio or television reception, which can be determined by turning the equipment off and on, the user is encouraged to try to correct the interference by one or more of the following measures:

- Reorient or relocate the receiving antenna.
- Increase the separation between the equipment and receiver.
- Connect the equipment into an outlet on a circuit different from that to which the receiver is connected.
- Consult the dealer or an experienced radio/TV technician for help.

Service

Driver Warranty

For warranty information, please visit www.lutron.com/driverwarranty

Replacement Parts

When ordering Lutron replacement parts, please provide the full model number. Consult Lutron if you have any questions.

Further Information

For further information, please visit us at www.lutron.com or contact our LED Control Center of Excellence at **1.877.346.5338** (U.S.A. and Canada only) or **LEDs@lutron.com**

 Lutron, Lutron, Hi-lume, GRAFIK Eye, PowPak, Quantum, HomeWorks, Pico, Nova T★, Nova, Skylark, Diva, Ariadni, Maestro, Maestro Wireless, RadioRA, Soft-on, Fade-to-Black, Energi Savr Node, QwigFig and EcoSystem are trademarks or registered trademarks of Lutron Electronics Co., Inc. in the US and/or other countries.

ENERGY STAR is a registered trademark of the U.S. Environmental Protection Agency

Job Name:	Model Numbers:
Job Number:	